



**HICKORY**  
HARDWARE®

2019 Edition



---

# OUR STORY

Hickory Hardware® is a value brand marketed by Belwith® Products, LLC. The roots of the company run deep, beginning with the birth of a small foundry in Michigan in 1893. From the humble beginnings of the Keeler Brass Company®, international corporate ownership and multiple mergers, we now emerge as Belwith® Products, LLC, a privately owned and operated firm.

Belwith Products has hundreds of years of staff experience, a living library of designs (dating back to 1900), and a passion to develop unique, inspired hardware. This positions us as the industry leader in kitchen cabinet, architectural, and furniture hardware.

Adding dramatic accent and subtle nuance to your kitchen cabinetry springs from our commitment to Old World craftsmanship, exemplified in every piece of decorative hardware we design and market. By including methods of pencil sketching, hand modeling and finishing, the most modern computer manufacturing tools only serve to compliment and enhance our design process. Technology and engineering back our products while artistry remains front and center.

Knowing design and development are only two facets of operational excellence, significant investment has been made in a world-wide sourcing and distribution network as well. Our engineers travel the globe selecting

world class manufacturers, and our quality assurance team maintains our high standards for functional quality, finish, and craftsmanship through rigorous physical testing and continual product analysis.

Our material management team utilizes the latest in forecasting and material flow technology. We fulfill customer orders on-time and complete direct from the factory, or through our expansive distribution center in Grandville, Michigan.

Belwith Products is comprised of unparalleled experience and talent. Our Grandville staff is fully equipped to handle the needs of retailers, showrooms, OEM manufacturers, and designers to create everyday designs and custom products.

Our commitment to provide consumers with a variety of trendsetting styles and finishes is proven through our extensive assortment of products, unique and convenient packaging, as well as displays and planograms which are always evolving to match current trends. Every step in product development is crucial and we take each step to the next level to ensure we provide the best and freshest products. The Hickory Hardware brand reflects our vision to offer the very best products and service to customers today, while providing continuous improvement in our product offerings and service for tomorrow.

# TABLE OF CONTENTS

## CONTEMPORARY COLLECTIONS \_\_\_\_\_ 10

Bar Pulls _____	12
Crest _____	17
Greenwich _____	20
Midway _____	24
Skylight _____	26
Streamline _____	30
Velocity _____	32
Wisteria _____	34

## CONTEMPORARY SELECTIONS \_\_\_\_\_ 36

Arc _____	37
Austere _____	38
Dew _____	40
Camarilla _____	41
Euro-Contemporary _____	42
Kite _____	45
Loft _____	46
Luna _____	47
Metropolis _____	48
Mito _____	52
Raleigh _____	52
Richmond _____	54
Rochester _____	55
Rockford _____	56
Surge _____	57
Swoop _____	58
Wire Pulls _____	59

## TRANSITIONAL COLLECTIONS \_\_\_\_\_ 62

American Diner _____	64
Bridges _____	70
Bungalow _____	74
Cottage _____	76
Forge _____	80
Savoy _____	84
Serendipity _____	86
Studio _____	88
Twist _____	96
Williamsburg _____	99
Willow _____	108
Zephyr _____	110

## TRANSITIONAL SELECTIONS \_\_\_\_\_ 112

Conquest _____	113
Modus _____	118

## TRADITIONAL COLLECTIONS \_\_\_\_\_ 120

Altair _____	122
Ithica _____	123
Somerset _____	124
Sydney _____	127

## TRADITIONAL SELECTIONS \_\_\_\_\_ 128

Cavalier _____	129
Chelsea _____	131
Crystal Palace _____	132
Deco _____	133
Eclipse _____	134
French Country _____	136
French Twist _____	136
Manor House _____	138
Mayfair _____	141
Palmetto _____	141
Ravel _____	142
Roma _____	142
Tranquility _____	143

## RUSTIC COLLECTIONS \_\_\_\_\_ 146

Arts & Crafts _____	148
Charleston Blacksmith _____	149
Craftsman _____	150
Manchester _____	152
Mountain Lodge _____	154
Pipeline _____	156
Refined Rustic _____	158

## RUSTIC SELECTIONS \_\_\_\_\_ 162

Bamboo _____	163
Bedrock _____	163
Carbonite _____	164
Clover Creek _____	164
Natural Woodcraft _____	165
Natural Accents _____	166
Old Mission _____	167
Southwest Lodge _____	169

# TABLE OF CONTENTS

<b>APPLIANCE PULLS</b> _____	<b>170</b>	<b>PROJECT PACKS</b> _____	<b>222</b>
American Diner _____	172	Pulls _____	222
Cottage _____	174	Knobs _____	223
Euro-Contemporary _____	175	Hinges _____	224
Refined Rustic _____	177	Screws _____	225
Studio _____	178	Multi Packs _____	226
Williamsburg _____	180		
Zephyr _____	184		
		<b>ELECTRONICS</b> _____	<b>228</b>
<b>HOOKS</b> _____	<b>186</b>	Electronic Keypad Deadbolt _____	228
American Diner Signature Hooks _____	188	Bluetooth Enabled Deadbolt _____	230
Bungalow Signature Hooks _____	189		
Cottage Signature Hooks _____	190		
Craftsman Signature Hooks _____	190		
Forge Signature Hooks _____	191		
Pipeline Signature Hooks _____	191		
Skylight Signature Hooks _____	192		
Hooks _____	192		
<b>FUNCTIONAL</b> _____	<b>196</b>		
Drawer Slide General Guidelines _____	198		
Drawer Slides _____	200		
Hinge General Guidelines _____	202		
Surface Free Swinging Hinges _____	206		
Surface Face Mount Hinges _____	207		
Accessories _____	207		
Surface Self-Closing Hinges _____	208		
Self-Closing Semi Concealed Wrap Hinges _____	210		
Double Demountable Hinges _____	212		
Single Demountable Hinges _____	213		
Self Mortise Hinges _____	213		
Concealed Hinges _____	214		
Concealed Self-Closing Hinges _____	216		
Concealed Soft Close Hinges _____	217		
Catches _____	218		
Hand Rail Brackets _____	219		
Mounting Templates _____	220		

# FINISH OVERVIEW

## SILVER TONES >



**14**  
Polished Nickel



**CA14**  
Crysacrylic Polished Nickel



**26/CH**  
Chrome



**26W**  
White Porcelain Chrome



**CACH**  
Crysacrylic Chrome



**CHSP**  
Chrome With Satin Pearl



**SP**  
SATIN PEARL



**GN**  
Glossy Nickel



**15/SN**  
Satin Nickel



**SC**  
Satin Silver Cloud



**CASN**  
Crysacrylic Satin Nickel



**SNW**  
Satin Nickel With White



**SNB**  
Satin Nickel With Black



**SS**  
Stainless Steel



**FCH**  
Frosted Chrome



**AL**  
Aluminum



**TN**  
Toasted Nickel



**SAS**  
Satin Antique Silver



**FN**  
Flat Nickel



**TCH**  
Two Tone Chrome



**ITN**  
Iced Tea Nickel



**CLX**  
Chromolux

## PEWTER TONES >



**BNV**  
BLACK NICKEL VIBED



**AP**  
ANTIQUE PEWTER



**ST**  
SILVER STONE



**VB**  
VIBRA PEWTER



**SM**  
SILVER MEDALLION

## GOLD TONES >



**UB**  
ULTRA BRASS



**3/PB**  
POLISHED BRASS



**RLB**  
ROLYAL BRASS



**BGB**  
BRUSHED GOLDEN BRASS



**EGN**  
ELUSIVE GOLDEN NICKEL



**FUB**  
FLAT ULTRA BRASS



**WDA/WOA**  
WINDOVER ANTIQUE



**LP**  
LANCASTER HAND POLISHED



**AB**  
ANTIQUE BRASS



**LB**  
LUSTRE BRASS



**AM**  
ANTIQUE MIST

COPPER TONES >



**CP**  
POLISHED  
COPPER



**AC**  
ANTIQUE COPPER



**DAC**  
DARK ANTIQUE  
COPPER

BRONZE TONES >



**VBZ**  
VENETI BRONZE



**VB**  
VINTAGE BRONZE



**RB**  
REFINED BRONZE



**OBH**  
OIL- RUBBED BRONZE  
HIGHLIGHTED



**SBZ**  
SATIN BRONZE



**RI**  
RUSTIC IRON

BLACK TONES >



**BLN**  
BLACK NICKEL



**BBLN**  
BRUSHED BLACK  
NICKEL



**22/BL**  
BLACK



**MB**  
MATTE BLACK



**FO**  
FLAT ONYX



**CB**  
COLONIAL BLACK



**10B**  
OIL-RUBBED  
BRONZE



**BI**  
BLACK IRON



**BMA**  
BLACK MIST  
ANTIQUE

MISC. >



**LU**  
LUCITE



**24/W**  
WHITE



**PR**  
PINK ROSE



**LAD**  
LIGHT  
ALMOND



**VC**  
VINTAGE BROWN  
CRACKLE



**UW**  
UNFINISHED  
WOOD



**BYA**  
BISCAYNE  
ANTIQUE

# ABOUT THIS CATALOG

## KEY

**C/C:** Center-to-Center

**W:** Width

**P:** Projection

**B:** Base

**L:** Length

**H:** Height

**D:** Diameter

## ARC

	PRODUCT SPECIFICATIONS						PART NUMBER	FINISH CODE	
	C/C	L	W	P	D	B		Satin Nickel	Vintage Bronze
<b>A</b>	-	-	-	15/16"	1-1/4"	5/16"	P3594-	SN	VB
<b>B</b>	3"	3-3/8"	7/16"	1"	-	-	P3595-	SN	VB

Record the "Part Number" including the hyphen followed by the "Finish Code." Example: HH075422-VB

SATIN NICKEL  
54% Scale

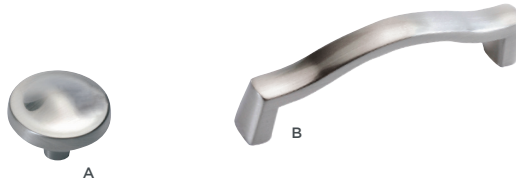

VINTAGE BRONZE  
54% Scale

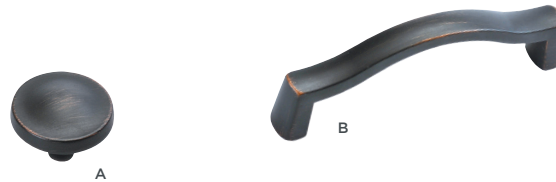

## MEASUREMENTS

See how the items are measured for the item descriptions.



**D:** Diameter



**B:** Base Diameter



**P:** Projection



**W:** Width



**L:** Length

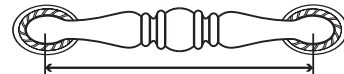

**C/C:** Screw Distance,  
Center to Center





---

# CONTEMPORARY

Clean lines, basic shapes, and simple in form.  
Contemporary hardware allows for the perfect  
accent to your modern kitchen and bath.



CONTEMPORARY

@sincerelysarad

# BAR PULLS

PRODUCT SPECIFICATIONS					PART NUMBER	FINISH CODE					
C/C	L	W	P	Chrome		Stainless Steel	Royal Brass	Vintage Bronze	Brushed Black Nickel	Matte Black	
<b>A</b>	-	2-3/8"	1/2"	1-1/4"	HH075591-	CH	SS	RLB	VB	BBLN	MB
<b>B</b>	64mm	4-7/8"	1/2"	1-1/4"	HH075592-	CH	SS	RLB	VB	BBLN	MB
<b>C</b>	3"	5-1/2"	1/2"	1-1/4"	HH075593-	CH	SS	RLB	VB	BBLN	MB
<b>D</b>	96mm	6"	1/2"	1-1/4"	HH075594-	CH	SS	RLB	VB	BBLN	MB
<b>E</b>	128mm	7-7/16"	1/2"	1-1/4"	HH075595-	CH	SS	RLB	VB	BBLN	MB
<b>F</b>	160mm	8-5/8"	1/2"	1-1/4"	HH075596-	CH	SS	RLB	VB	BBLN	MB
<b>G</b>	192mm	10"	1/2"	1-1/4"	HH075597-	CH	SS	RLB	VB	BBLN	MB
<b>H</b>	224mm	11-3/16"	1/2"	1-1/4"	HH075598-	CH	SS	RLB	VB	BBLN	MB
<b>I</b>	256mm	12-7/16"	1/2"	1-1/4"	HH075599-	CH	SS	RLB	VB	BBLN	MB

Record the "Part Number" including the hyphen followed by the "Finish Code." Example: HH075422-VB

## STAINLESS STEEL 32% Scale

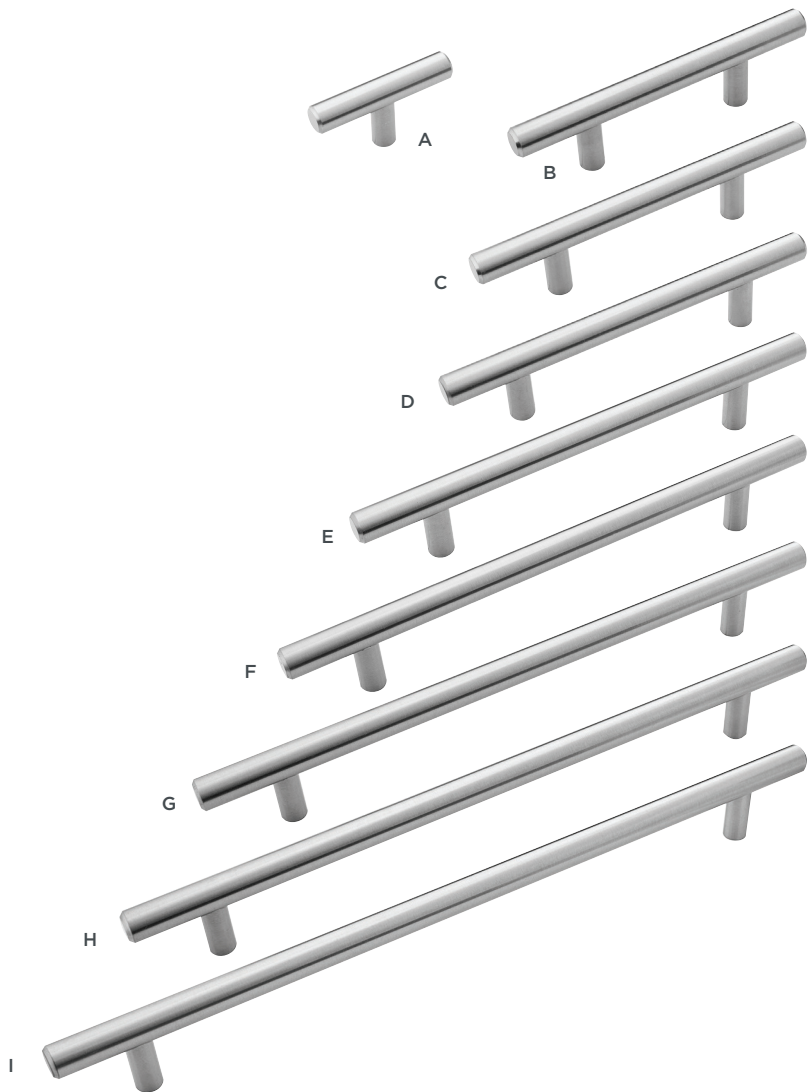

CHROME  
54% Scale

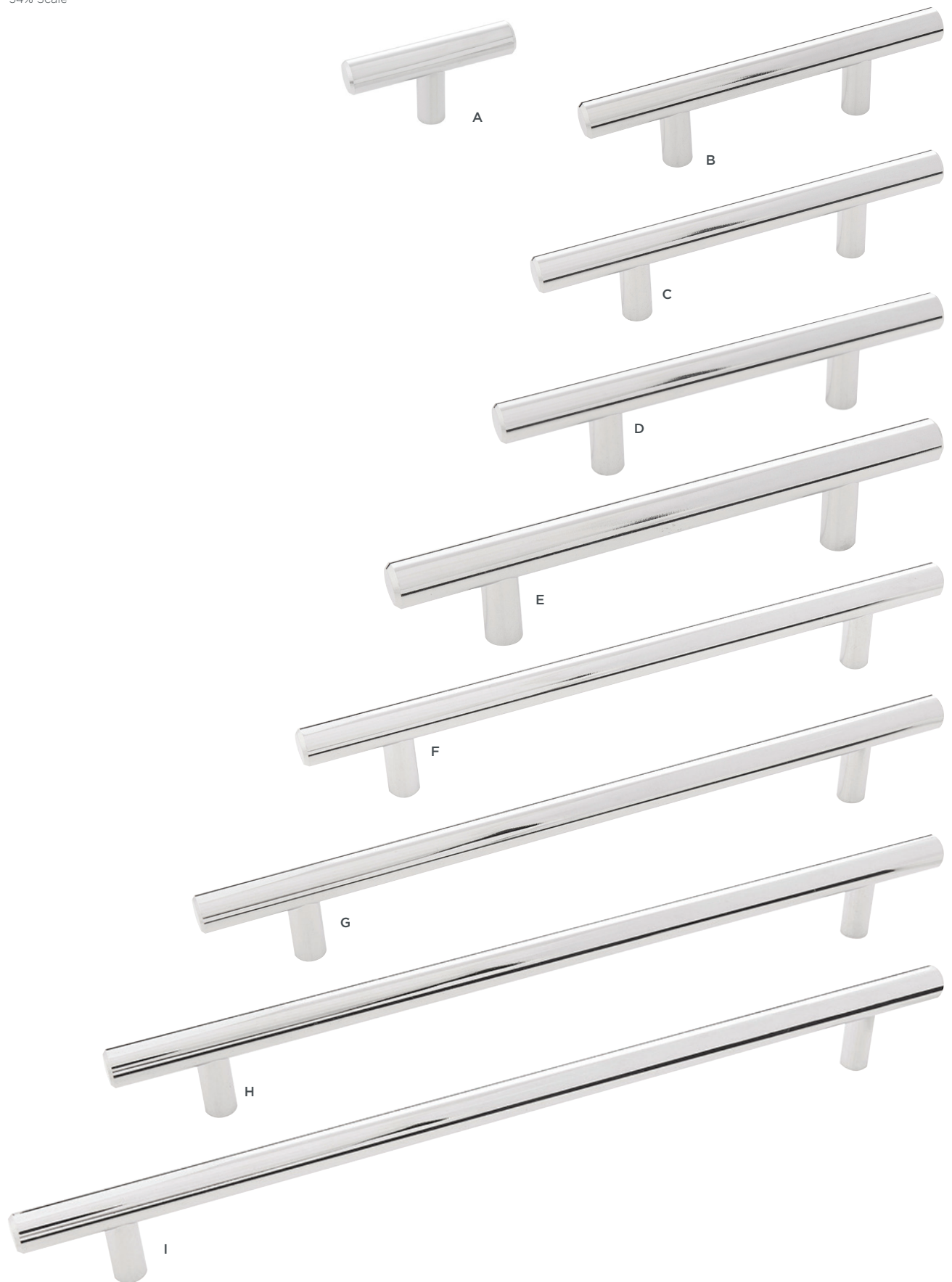

# BAR PULLS

PRODUCT SPECIFICATIONS					PART NUMBER	FINISH CODE					
C/C	L	W	P	Chrome		Stainless Steel	Royal Brass	Vintage Bronze	Brushed Black Nickel	Matte Black	
<b>A</b>	-	2-3/8"	1/2"	1-1/4"	HH075591-	CH	SS	RLB	VB	BBLN	MB
<b>B</b>	64mm	4-7/8"	1/2"	1-1/4"	HH075592-	CH	SS	RLB	VB	BBLN	MB
<b>C</b>	3"	5-1/2"	1/2"	1-1/4"	HH075593-	CH	SS	RLB	VB	BBLN	MB
<b>D</b>	96mm	6"	1/2"	1-1/4"	HH075594-	CH	SS	RLB	VB	BBLN	MB
<b>E</b>	128mm	7-7/16"	1/2"	1-1/4"	HH075595-	CH	SS	RLB	VB	BBLN	MB
<b>F</b>	160mm	8-5/8"	1/2"	1-1/4"	HH075596-	CH	SS	RLB	VB	BBLN	MB
<b>G</b>	192mm	10"	1/2"	1-1/4"	HH075597-	CH	SS	RLB	VB	BBLN	MB
<b>H</b>	224mm	11-3/16"	1/2"	1-1/4"	HH075598-	CH	SS	RLB	VB	BBLN	MB
<b>I</b>	256mm	12-7/16"	1/2"	1-1/4"	HH075599-	CH	SS	RLB	VB	BBLN	MB

Record the "Part Number" including the hyphen followed by the "Finish Code." Example: HH075422-VB

## ROYAL BRASS 32% Scale

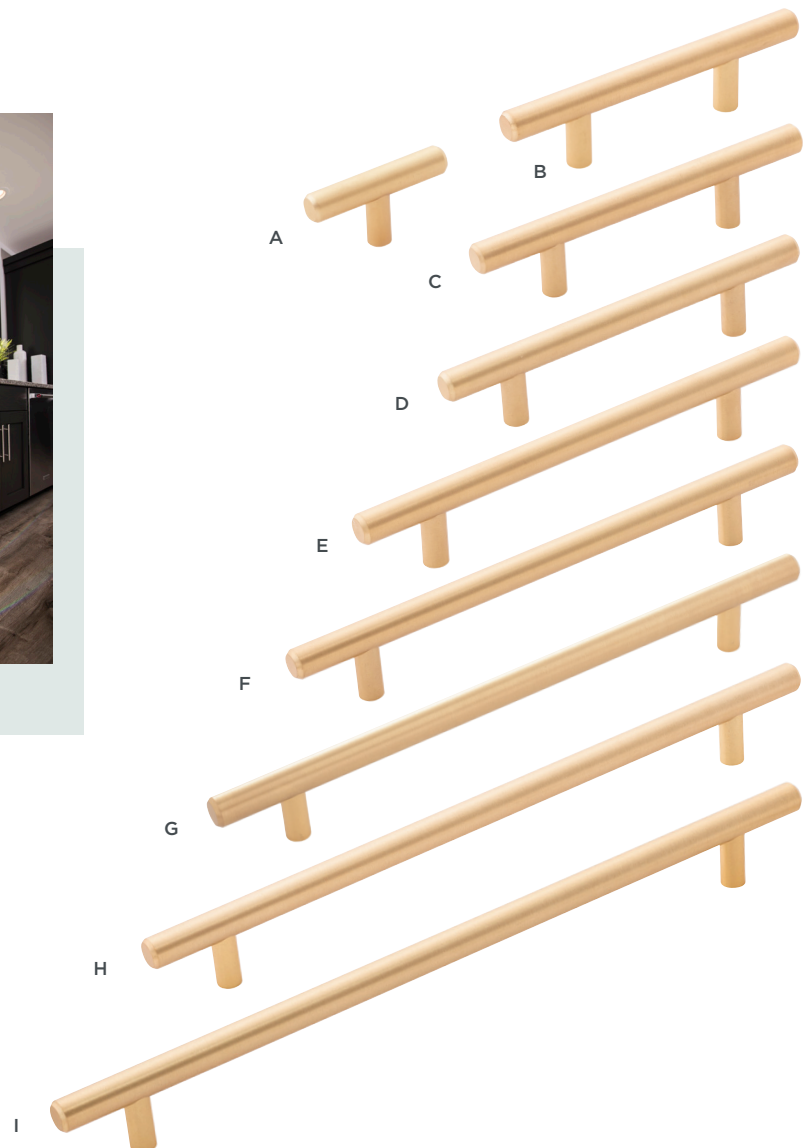

VINTAGE BRONZE  
32% Scale

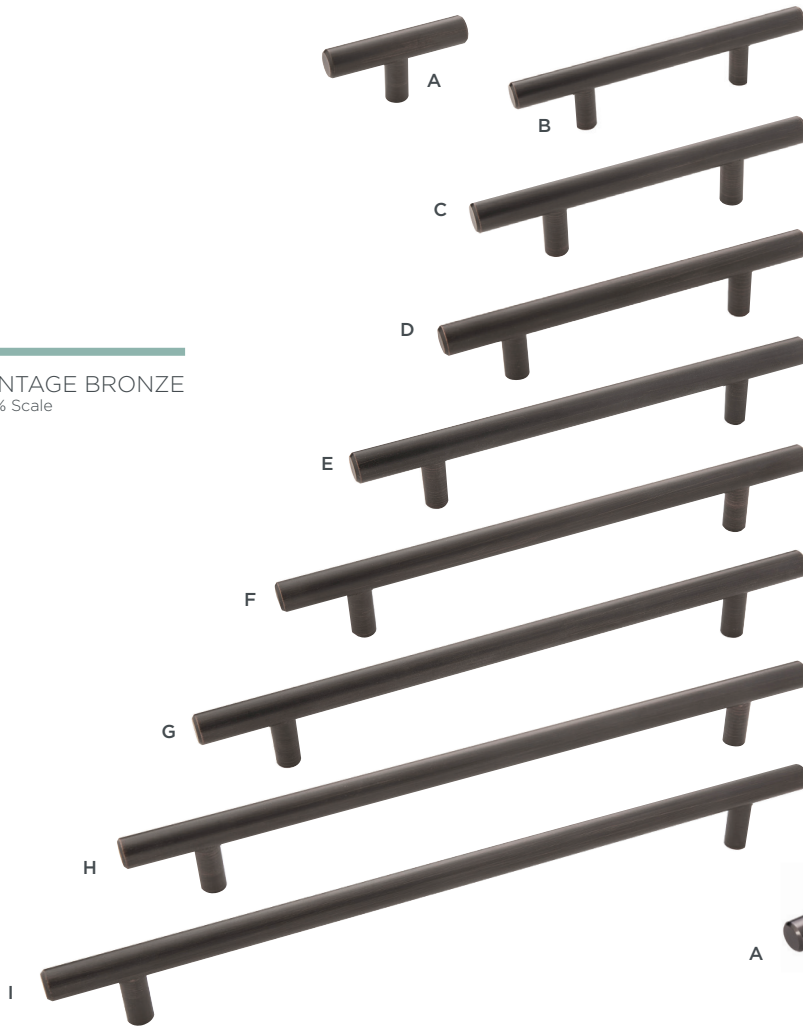

BRUSHED BLACK NICKEL  
32% Scale

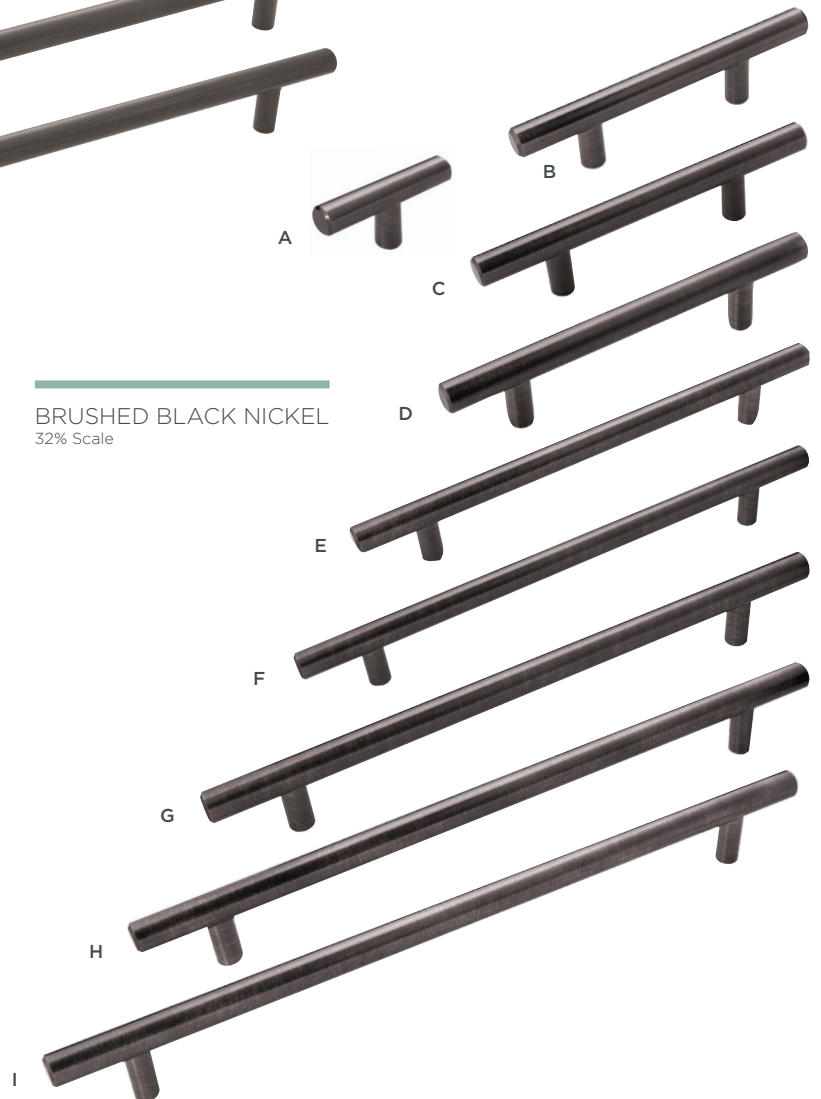

# BAR PULLS

PRODUCT SPECIFICATIONS					PART NUMBER	FINISH CODE				
C/C	L	W	P	Chrome		Stainless Steel	Vintage Bronze	Brushed Black Nickel	Matte Black	
<b>A</b>	-	2-3/8"	1/2"	1-1/4"	HH075591-	CH	SS	VB	BBLN	MB
<b>B</b>	64mm	4-7/8"	1/2"	1-1/4"	HH075592-	CH	SS	VB	BBLN	MB
<b>C</b>	3"	5-1/2"	1/2"	1-1/4"	HH075593-	CH	SS	VB	BBLN	MB
<b>D</b>	96mm	6"	1/2"	1-1/4"	HH075594-	CH	SS	VB	BBLN	MB
<b>E</b>	128mm	7-7/16"	1/2"	1-1/4"	HH075595-	CH	SS	VB	BBLN	MB
<b>F</b>	160mm	8-5/8"	1/2"	1-1/4"	HH075596-	CH	SS	VB	BBLN	MB
<b>G</b>	192mm	10"	1/2"	1-1/4"	HH075597-	CH	SS	VB	BBLN	MB
<b>H</b>	224mm	11-3/16"	1/2"	1-1/4"	HH075598-	CH	SS	VB	BBLN	MB
<b>I</b>	256mm	12-7/16"	1/2"	1-1/4"	HH075599-	CH	SS	VB	BBLN	MB

Record the "Part Number" including the hyphen followed by the "Finish Code." Example: HH075422-VB



**MATTE BLACK**  
32% Scale

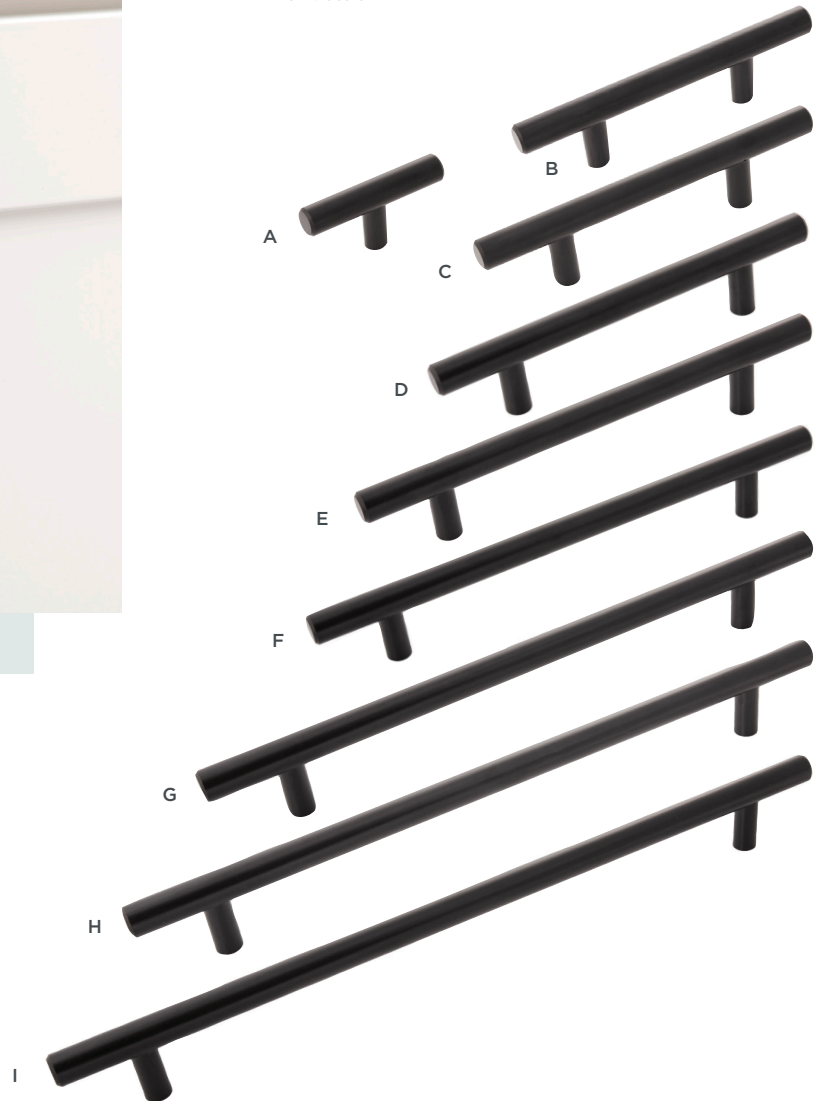



	PRODUCT SPECIFICATIONS						PART NUMBER	FINISH CODE		
	C/C	L	W	P	D	B		Chrome	Satin Nickel	Flat Ultra Brass
<b>A</b>	96mm	4-5/16"	5/8"	1"	-	-	H076130-	CH	SN	FUB
<b>B</b>	-	-	-	1-1/4"	1-1/4"	7/16"	H076128-	CH	SN	FUB
<b>C</b>	-	1-1/4"	1-1/4"	1"	-	7/16"	H076127-	CH	SN	FUB
<b>D</b>	192mm	8-1/16"	5/8"	1"	-	-	H076133-	CH	SN	FUB
<b>E</b>	3"	3-1/2"	5/8"	1"	-	-	H076129-	CH	SN	FUB
<b>F</b>	12"	12-1/2"	5/8"	1-1/16"	-	-	H076135-	CH	SN	FUB
<b>G</b>	224mm	9-5/16"	5/8"	1-1/16"	-	-	H076134-	CH	SN	FUB
<b>H</b>	160mm	6-13/16"	5/8"	1"	-	-	H076132-	CH	SN	FUB
<b>I</b>	128mm	5-9/16"	5/8"	1"	-	-	H076131-	CH	SN	FUB

Record the "Part Number" including the hyphen followed by the "Finish Code." Example: HH075422-VB

CHROME  
54% Scale



# CREST

	PRODUCT SPECIFICATIONS						PART NUMBER	FINISH CODE		
	C/C	L	W	P	D	B		Chrome	Satin Nickel	Flat Ultra Brass
<b>A</b>	96mm	4-5/16"	5/8"	1"	-	-	H076130-	CH	SN	FUB
<b>B</b>	-	-	-	1-1/4"	1-1/4"	7/16"	H076128-	CH	SN	FUB
<b>C</b>	-	1-1/4"	1-1/4"	1"	-	7/16"	H076127-	CH	SN	FUB
<b>D</b>	192mm	8-1/16"	5/8"	1"	-	-	H076133-	CH	SN	FUB
<b>E</b>	3"	3-1/2"	5/8"	1"	-	-	H076129-	CH	SN	FUB
<b>F</b>	12"	12-1/2"	5/8"	1-1/16"	-	-	H076135-	CH	SN	FUB
<b>G</b>	224mm	9-5/16"	5/8"	1-1/16"	-	-	H076134-	CH	SN	FUB
<b>H</b>	160mm	6-13/16"	5/8"	1"	-	-	H076132-	CH	SN	FUB
<b>I</b>	128mm	5-9/16"	5/8"	1"	-	-	H076131-	CH	SN	FUB

Record the "Part Number" including the hyphen followed by the "Finish Code." Example: HH075422-VB

SATIN NICKEL  
54% Scale

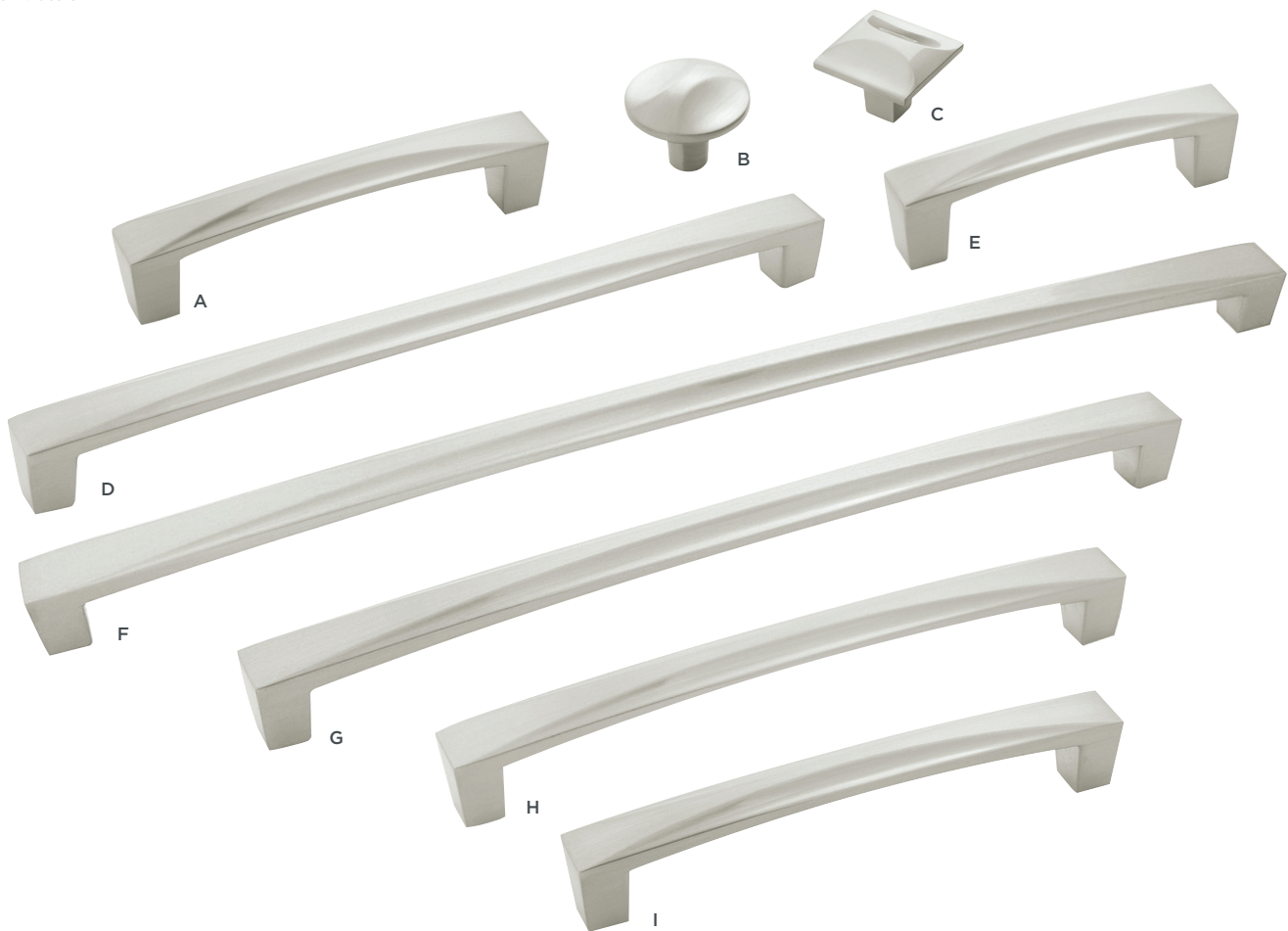

FLAT ULTRA BRASS  
54% Scale

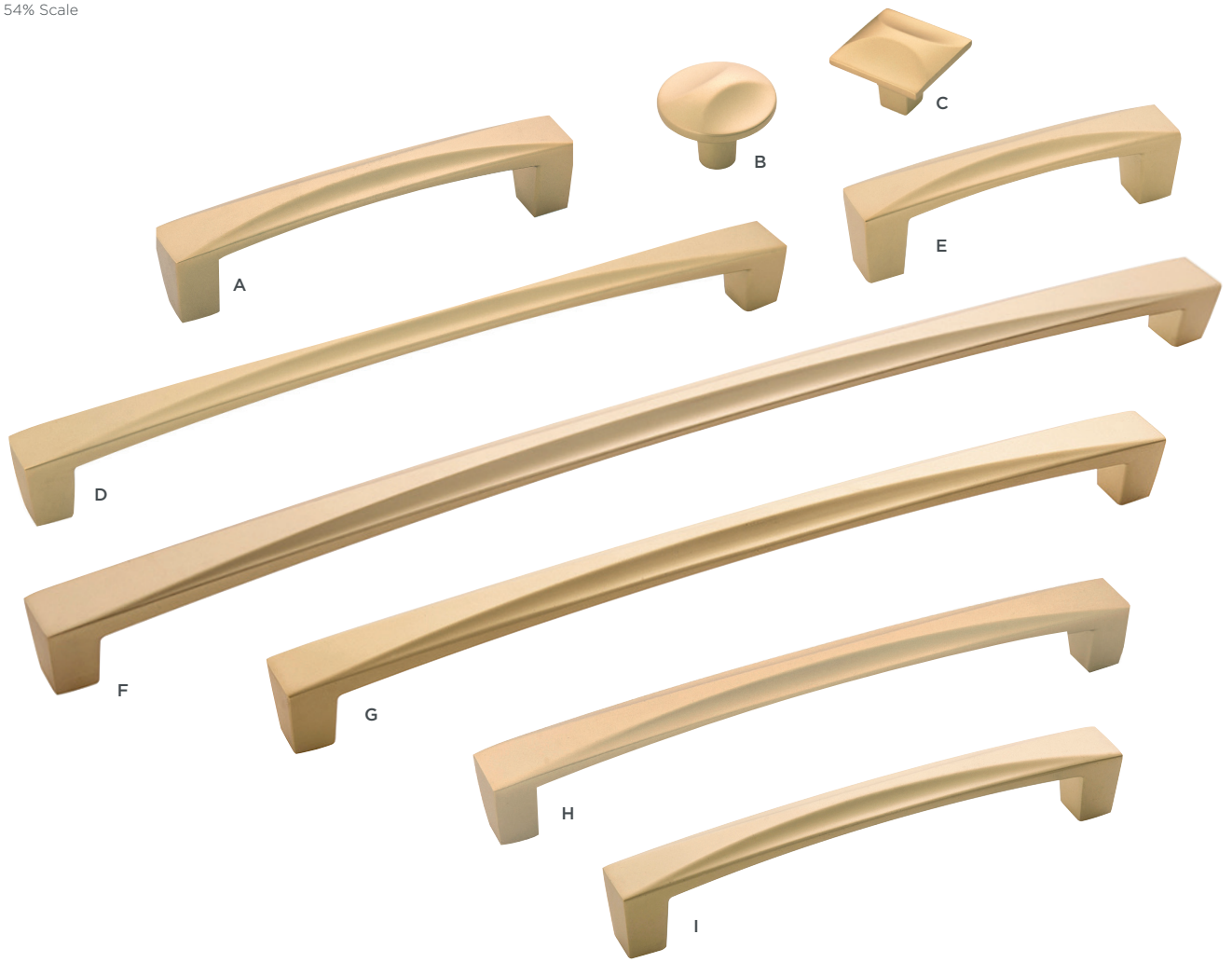

# GREENWICH

	PRODUCT SPECIFICATIONS					PART NUMBER	FINISH CODE			
	C/C	L	W	P	B		Polished Nickel	Stainless Steel	Windover Antique	Oil-Rubbed Bronze
<b>A</b>	128mm	6-3/8"	7/16"	1-1/8"	-	P3371-	14	SS	WOA	10B
<b>B</b>	224mm	10"	1/2"	1-3/8"	-	P3041-	14	SS	WOA	10B
<b>C</b>	12"	13-1/4"	1/2"	1-3/8"	-	P3374-	14	SS	WOA	10B
<b>D</b>	18"	19-1/4"	1/2"	1-3/8"	-	P3375-	14	SS	WOA	10B
<b>E</b>	3" & 96mm	4-5/16"	3/8"	15/16"	-	P3370-	14	SS	WOA	10B
<b>F</b>	-	1-3/4"	1/2"	1/2"	1/2"	P3372-	14	SS	WOA	10B

Record the "Part Number" including the hyphen followed by the "Finish Code." Example: HH075422-VB

## POLISHED NICKEL 54% Scale





STAINLESS STEEL

32% Scale

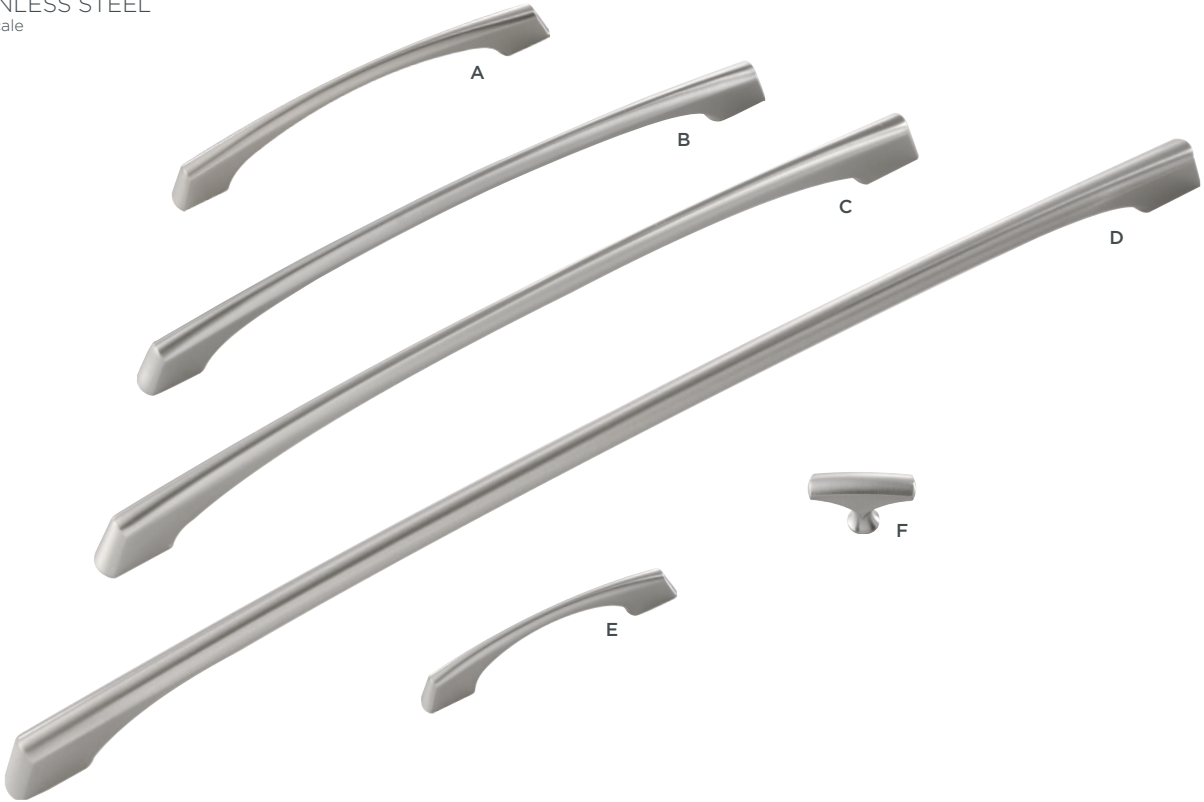

# GREENWICH

	PRODUCT SPECIFICATIONS					PART NUMBER	FINISH CODE			
	C/C	L	W	P	B		Polished Nickel	Stainless Steel	Windover Antique	Oil-Rubbed Bronze
<b>A</b>	128mm	6-3/8"	7/16"	1-1/8"	-	P3371-	14	SS	WOA	10B
<b>B</b>	224mm	10"	1/2"	1-3/8"	-	P3041-	14	SS	WOA	10B
<b>C</b>	12"	13-1/4"	1/2"	1-3/8"	-	P3374-	14	SS	WOA	10B
<b>D</b>	18"	19-1/4"	1/2"	1-3/8"	-	P3375-	14	SS	WOA	10B
<b>E</b>	3" & 96mm	4-5/16"	3/8"	15/16"	-	P3370-	14	SS	WOA	10B
<b>F</b>	-	1-3/4"	1/2"	1/2"	1/2"	P3372-	14	SS	WOA	10B

Record the "Part Number" including the hyphen followed by the "Finish Code." Example: HH075422-VB



WINDOVER ANTIQUE  
32% Scale.



OIL-RUBBED BRONZE  
32% Scale

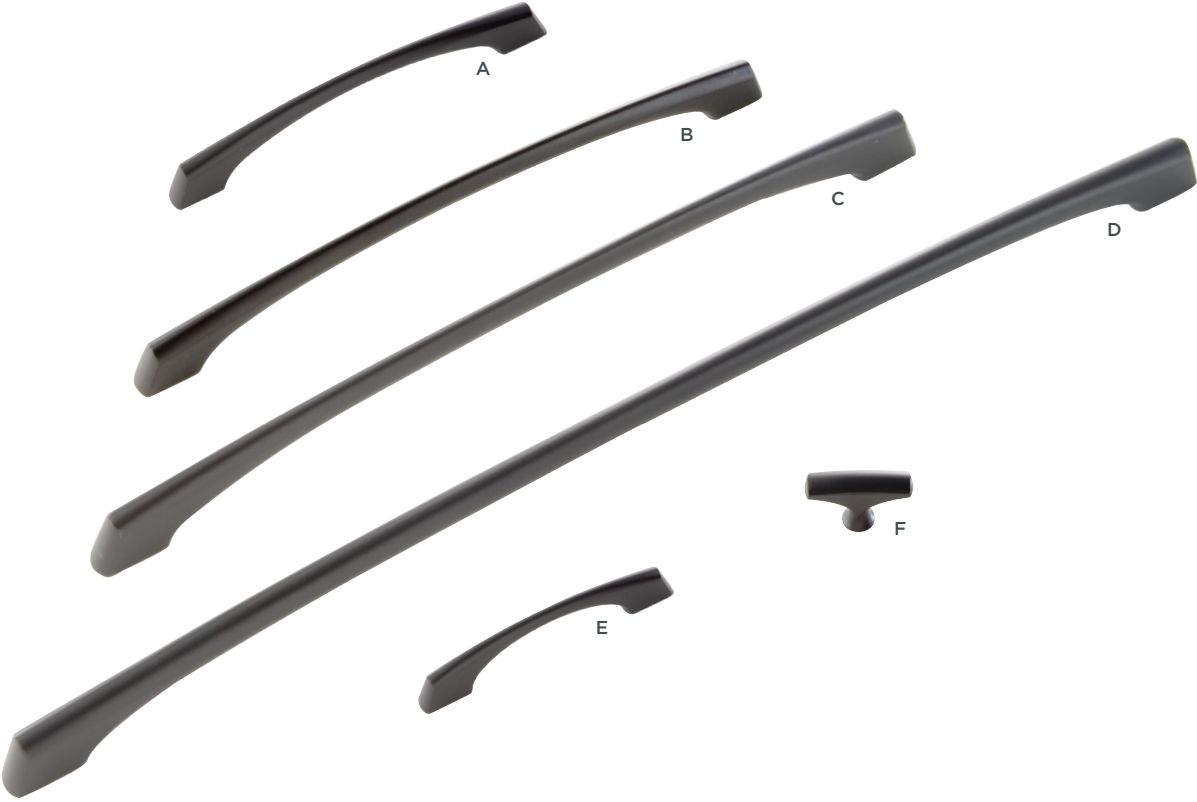

# MIDWAY

	PRODUCT SPECIFICATIONS						PART NUMBER	FINISH CODE		
	C/C	L	W	P	D	B		Crysacrylic with Chrome	Crysacrylic with Satin Nickel	Crysacrylic with Brushed Golden Brass
<b>A</b>	128m	5-3/4"	13/16"	1-9/16"	-	-	P3635-	CACH	CASN	CABGB
<b>B</b>	160mm	7"	13/16"	1-9/16"	-	-	P3702-	CACH	CASN	CABGB
<b>C</b>	192mm	8-1/4"	13/16"	1-9/16"	-	-	P3703-	CACH	CASN	CABGB
<b>D</b>	12"	12-11/16"	13/16"	1-9/16"	-	-	P3711-	CACH	CASN	CABGB
<b>E</b>	224mm	9-1/2"	13/16"	1-9/16"	-	-	P3704-	CACH	CASN	CABGB
<b>F</b>	-	-	-	1-1/16"	1"	5/8"	P3708-	CACH	CASN	CABGB
<b>G</b>	-	-	-	1-5/16"	1-1/4"	13/16"	P3709-	CACH	CASN	CABGB

Record the "Part Number" including the hyphen followed by the "Finish Code." Example: HH075422-VB

## CRYSACRYLIC WITH CHROME

54% Scale





CRYSACRYLIC WITH SATIN NICKEL  
32% Scale

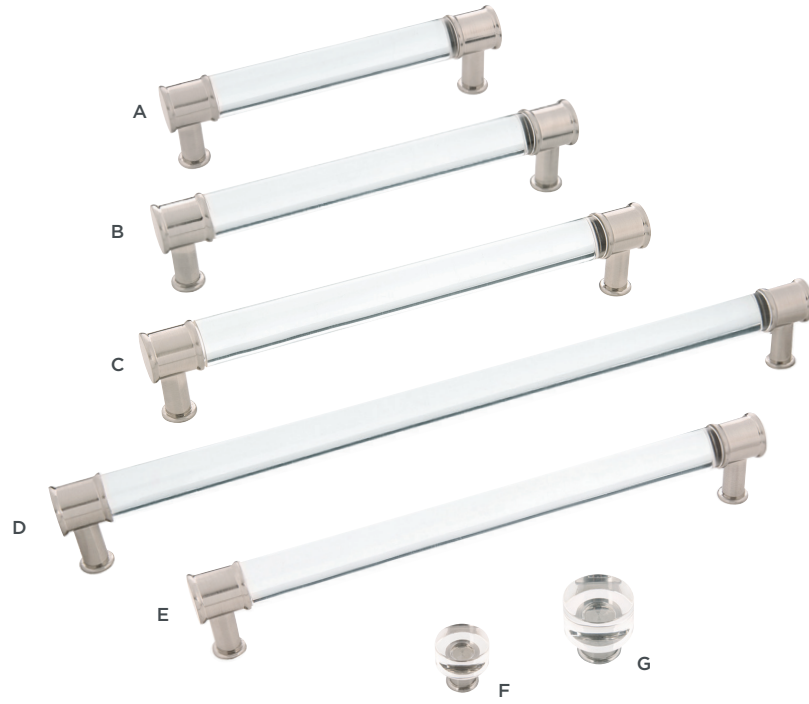

CRYSACRYLIC WITH BRUSHED GOLDEN BRASS  
32% Scale

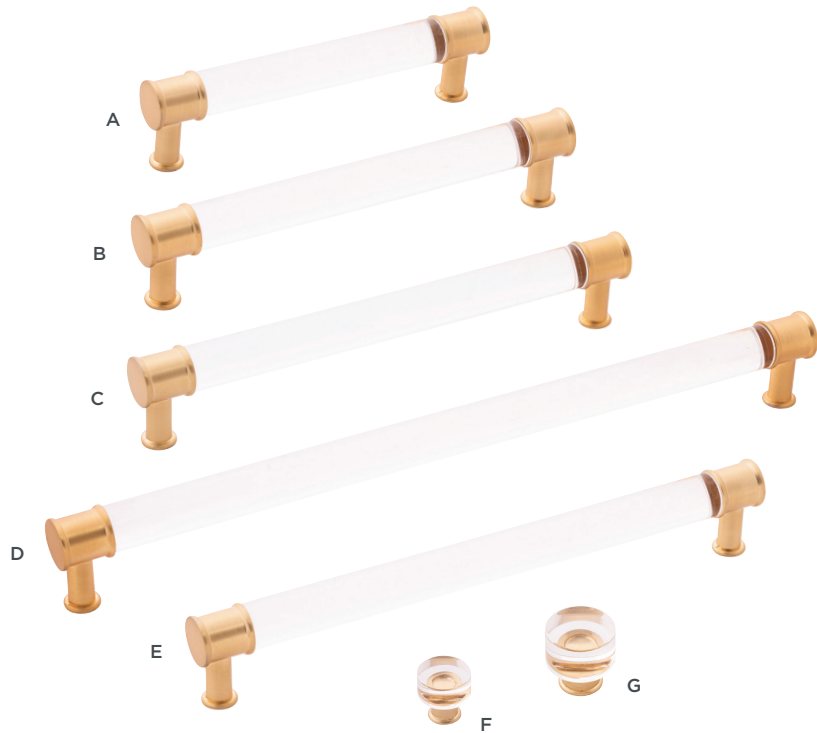

# SKYLIGHT

PRODUCT SPECIFICATIONS						PART NUMBER	FINISH CODE				
C/C	L	W	P	B	Polished Nickel		Stainless Steel	Elusive Golden Nickel	Brushed Golden Brass	Vintage Bronze	
<b>A</b>	3"	3-3/8"	3/8"	1-1/8"	-	HH075326-	14	SS	EGN	BGB	VB
<b>B</b>	-	1-1/4"	1-1/4"	1"	3/8" SQ.	HH075341-	14	SS	EGN	BGB	VB
<b>C</b>	96mm	4-3/16"	3/8"	1-1/8"	-	HH075327-	14	SS	EGN	BGB	VB
<b>D</b>	128mm	5-7/16"	3/8"	1-1/8"	-	HH075328-	14	SS	EGN	BGB	VB
<b>E</b>	18"	18-1/2"	1/2"	1-3/8"	-	HH075337-	14	SS	EGN	BGB	VB
<b>F</b>	12"	12-7/16"	7/16"	1-1/4"	-	HH075336-	14	SS	EGN	BGB	VB
<b>G</b>	224mm	9-1/4"	7/16"	1-1/4"	-	HH075422-	14	SS	EGN	BGB	VB
<b>H</b>	160mm	6-3/4"	3/8"	1-1/4"	-	HH075329-	14	SS	EGN	BGB	VB

Record the "Part Number" including the hyphen followed by the "Finish Code." Example: HH075422-VB

## POLISHED NICKEL 54% Scale

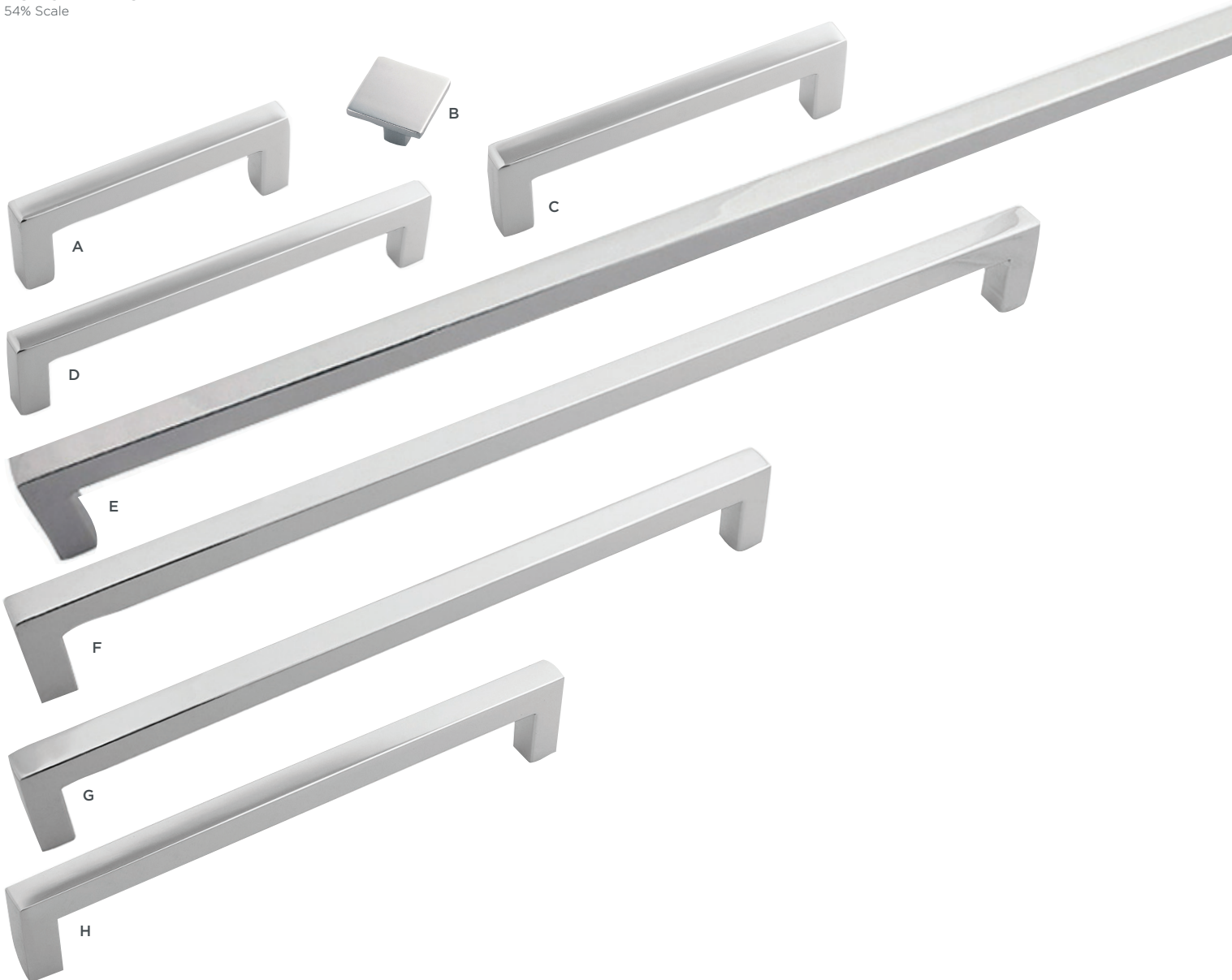



STAINLESS STEEL  
32% Scale

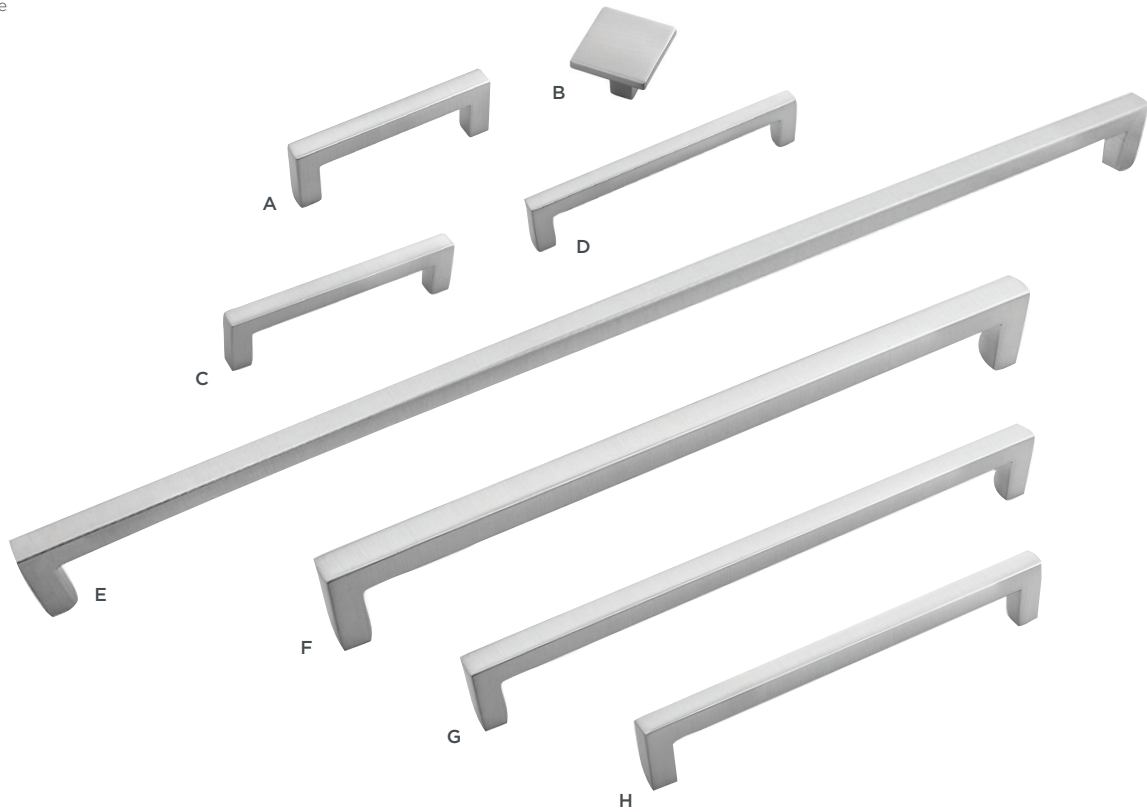

# SKYLIGHT

	PRODUCT SPECIFICATIONS					PART NUMBER	FINISH CODE				
	C/C	L	W	P	B		Polished Nickel	Stainless Steel	Elusive Golden Nickel	Brushed Golden Brass	Vintage Bronze
<b>A</b>	3"	3-3/8"	3/8"	1-1/8"	-	HH075326-	14	SS	EGN	BGB	VB
<b>B</b>	-	1-1/4"	1-1/4"	1"	3/8" SQ.	HH075341-	14	SS	EGN	BGB	VB
<b>C</b>	96mm	4-3/16"	3/8"	1-1/8"	-	HH075327-	14	SS	EGN	BGB	VB
<b>D</b>	128mm	5-7/16"	3/8"	1-1/8"	-	HH075328-	14	SS	EGN	BGB	VB
<b>E</b>	18"	18-1/2"	1/2"	1-3/8"	-	HH075337-	14	SS	EGN	BGB	VB
<b>F</b>	12"	12-7/16"	7/16"	1-1/4"	-	HH075336-	14	SS	EGN	BGB	VB
<b>G</b>	224mm	9-1/4"	7/16"	1-1/4"	-	HH075422-	14	SS	EGN	BGB	VB
<b>H</b>	160mm	6-3/4"	3/8"	1-1/4"	-	HH075329-	14	SS	EGN	BGB	VB

Record the "Part Number" including the hyphen followed by the "Finish Code." Example: HH075422-VB

## ELUSIVE GOLDEN NICKEL 32% Scale

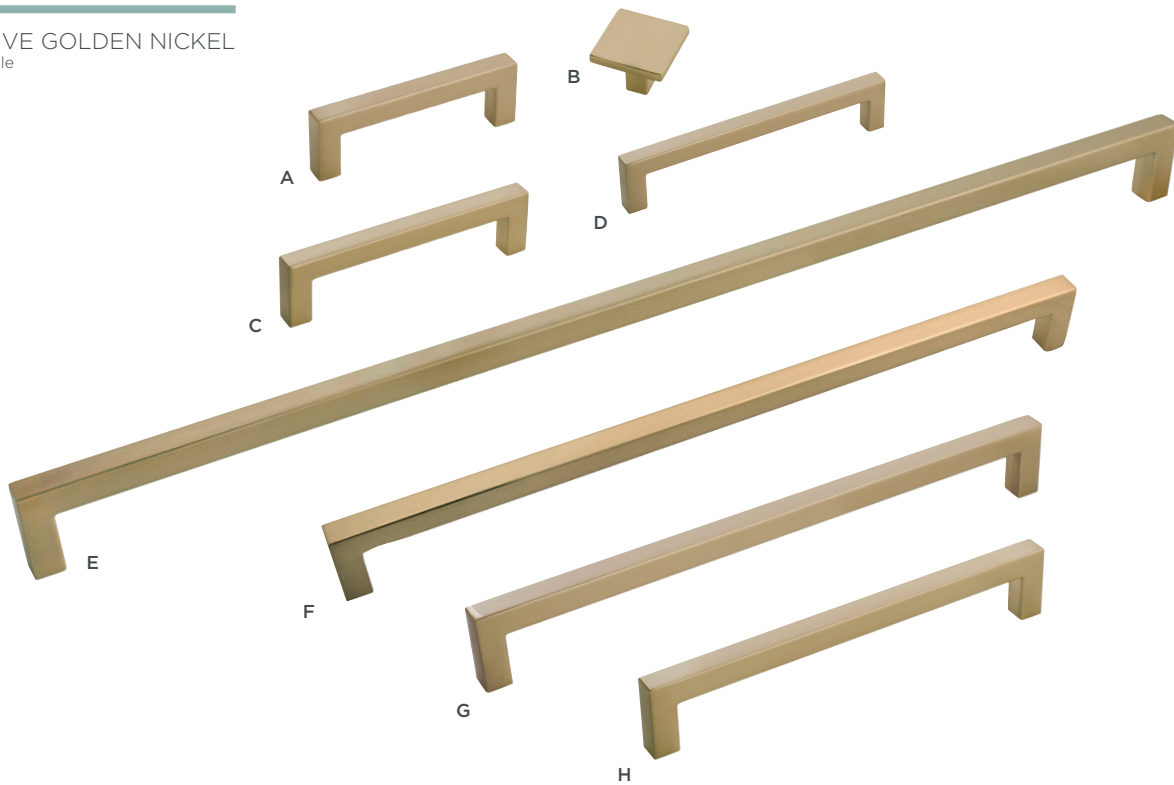

### MATCHING HOOKS AVAILABLE

See page 192 for specs and finish options. Not to scale.



BRUSHED GOLDEN BRASS  
32% Scale

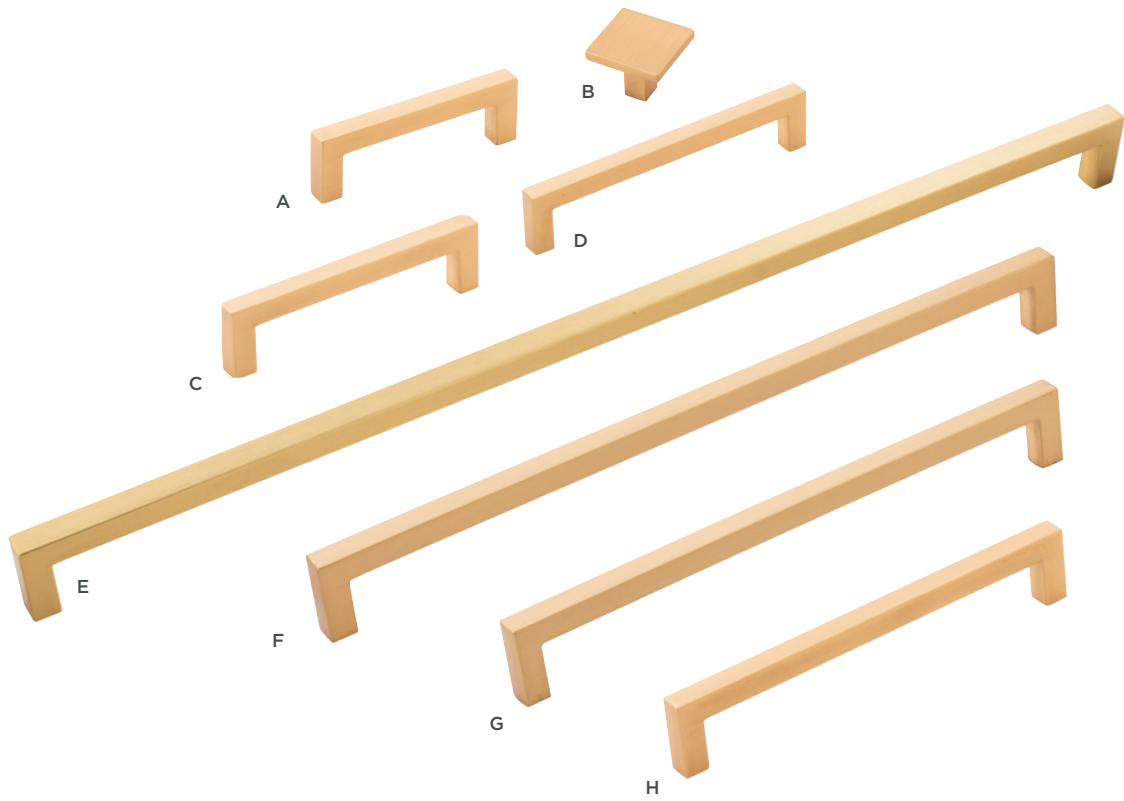

VINTAGE BRONZE  
32% Scale

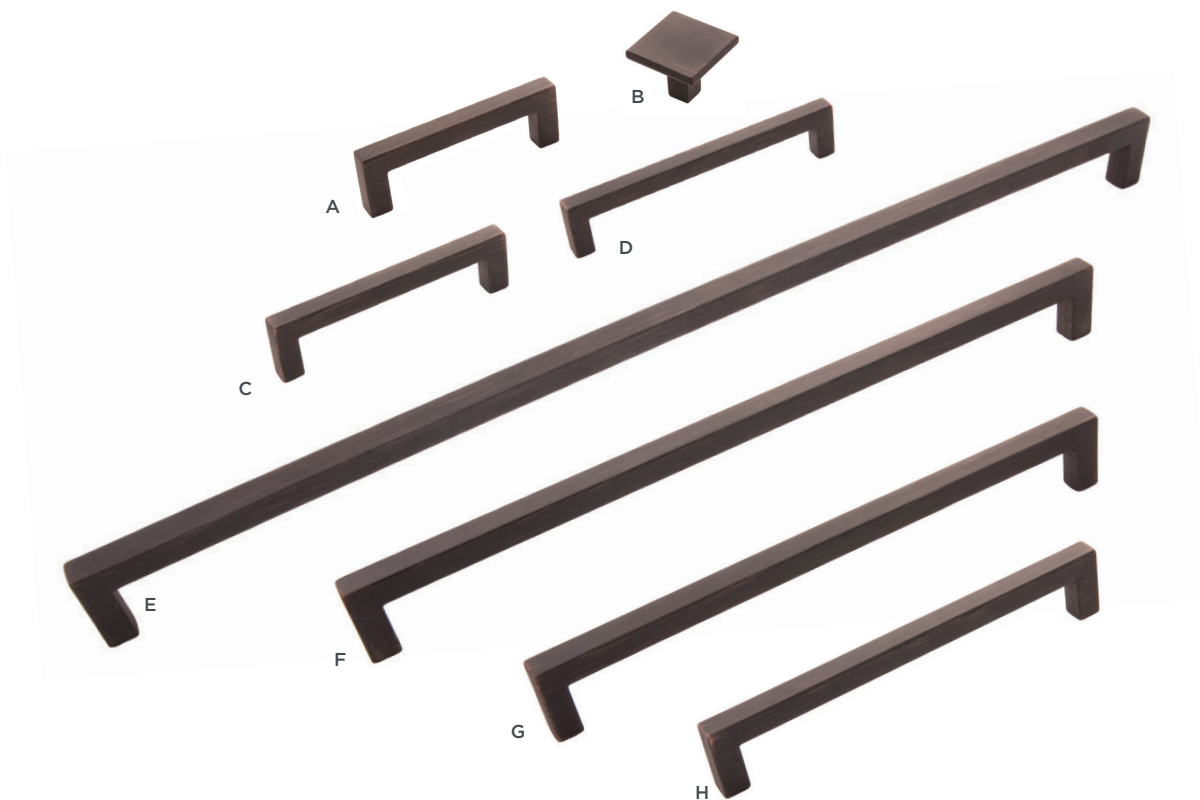

# STREAMLINE

	PRODUCT SPECIFICATIONS				PART NUMBER	FINISH CODE		
	C/C	L	W	P		Glossy Nickel	Toasted Nickel	Flat Onyx
<b>A</b>	32mm	2"	1/2"	3/4"	HH075280-	GN	TN	FO
<b>B</b>	3"	3-3/4"	1/2"	3/4"	HH075266-	GN	TN	FO
<b>C</b>	128mm	5-3/4"	1/2"	3/4"	HH075268-	GN	TN	FO
<b>D</b>	96mm	4-1/2"	1/2"	3/4"	HH075267-	GN	TN	FO
<b>E</b>	192mm	9-1/2"	1/2"	3/4"	HH076264-	GN	TN	FO
<b>F</b>	12"	14"	1/2"	3/4"	HH076266-	GN	TN	FO
<b>G</b>	224mm	11"	1/2"	3/4"	HH076265-	GN	TN	FO
<b>H</b>	160mm	7"	1/2"	3/4"	HH075281-	GN	TN	FO

Record the "Part Number" including the hyphen followed by the "Finish Code." Example: HH075422-VB

GLOSSY NICKEL  
54% Scale

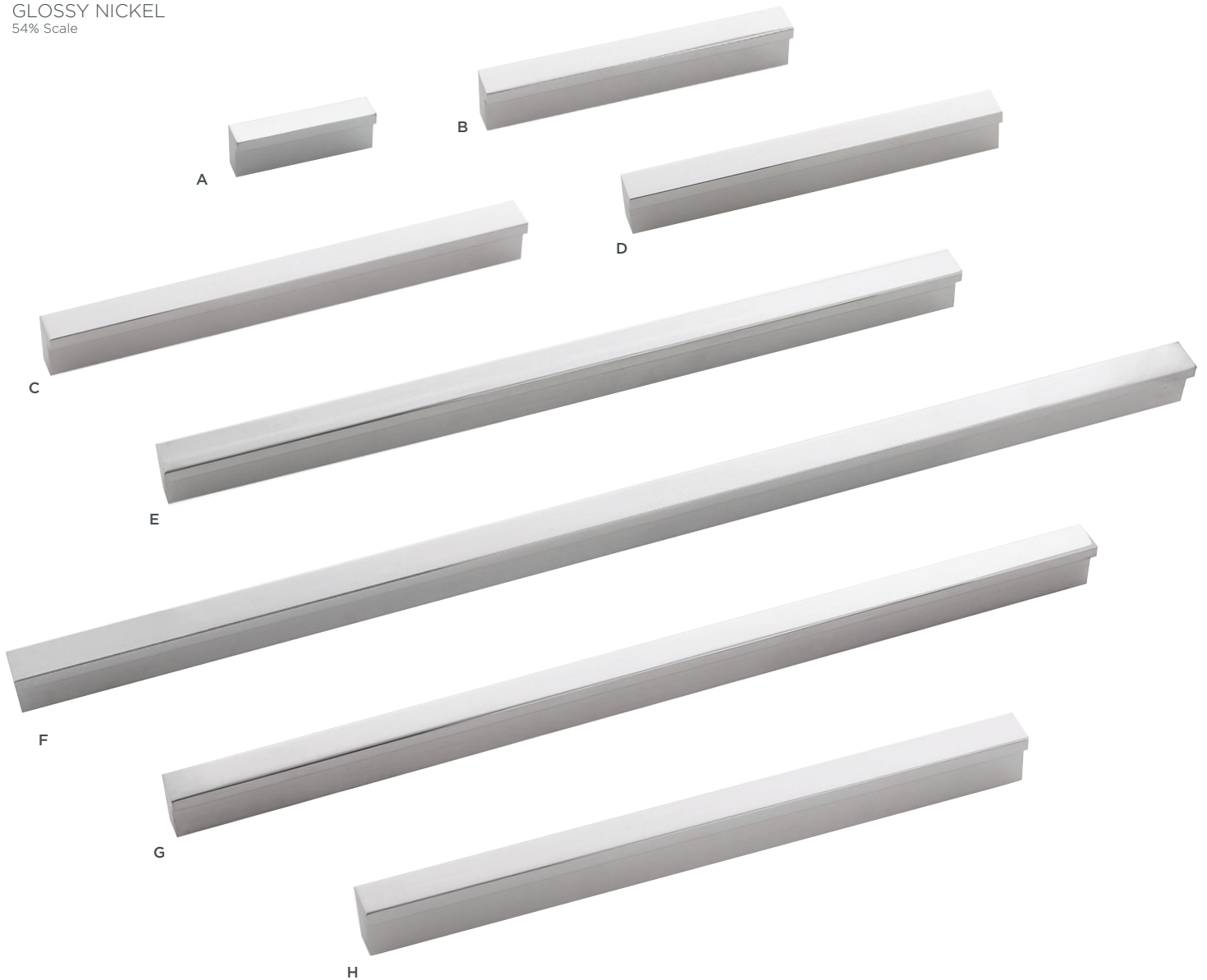

TOASTED NICKEL  
32% Scale

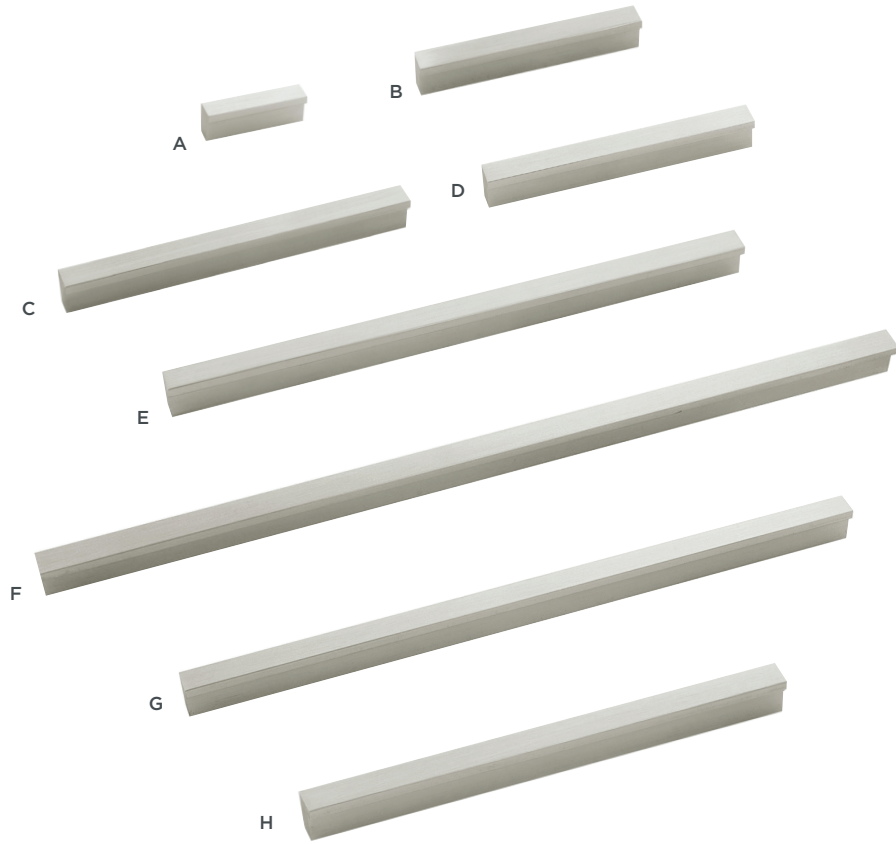

FLAT ONYX  
32% Scale

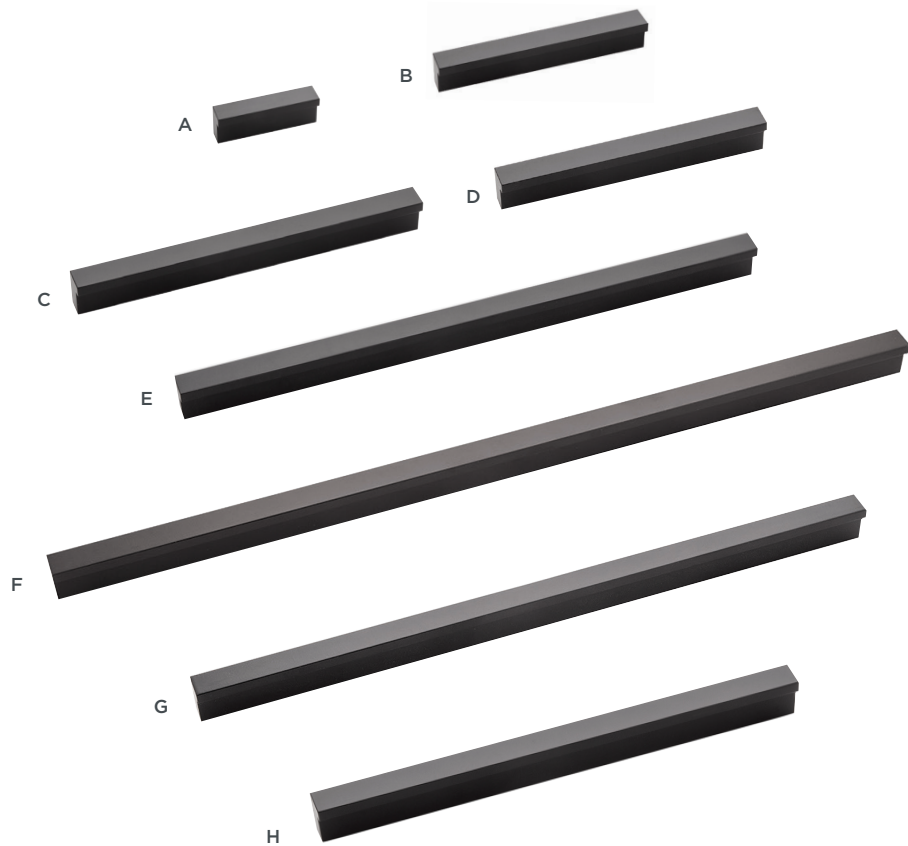

# VELOCITY

	PRODUCT SPECIFICATIONS					PART NUMBER	FINISH CODE	
	C/C	L	W	P	B		Polished Nickel	Flat Ultra Brass
<b>A</b>	3" & 96mm	5-3/4"	1-5/16"	1"	-	HH74642-	14	FUB
<b>B</b>	160mm	8"	9/16"	1-1/16"	-	HH74732-	14	FUB
<b>C</b>	-	1-7/16"	11/16"	1"	1/2" x 3/8"	HH74641-	14	-
<b>CA</b>	-	1-7/16"	11/16"	1"	1/2" x 3/8"	HH074641-	-	FUB
<b>D</b>	18"	19-15/16"	13/16"	1-3/8"	-	HH074856-	14	FUB
<b>E</b>	12"	13-7/8"	13/16"	1-1/4"	-	HH074855-	14	FUB
<b>F</b>	128mm	6-9/16"	9/16"	1-1/16"	-	HH74631-	14	FUB
<b>G</b>	3" & 96mm	4-7/8"	1/2"	1"	-	HH74561-	14	FUB

Record the "Part Number" including the hyphen followed by the "Finish Code." Example: HH075422-VB

## POLISHED NICKEL 54% Scale







FLAT ULTRA BRASS  
32% Scale

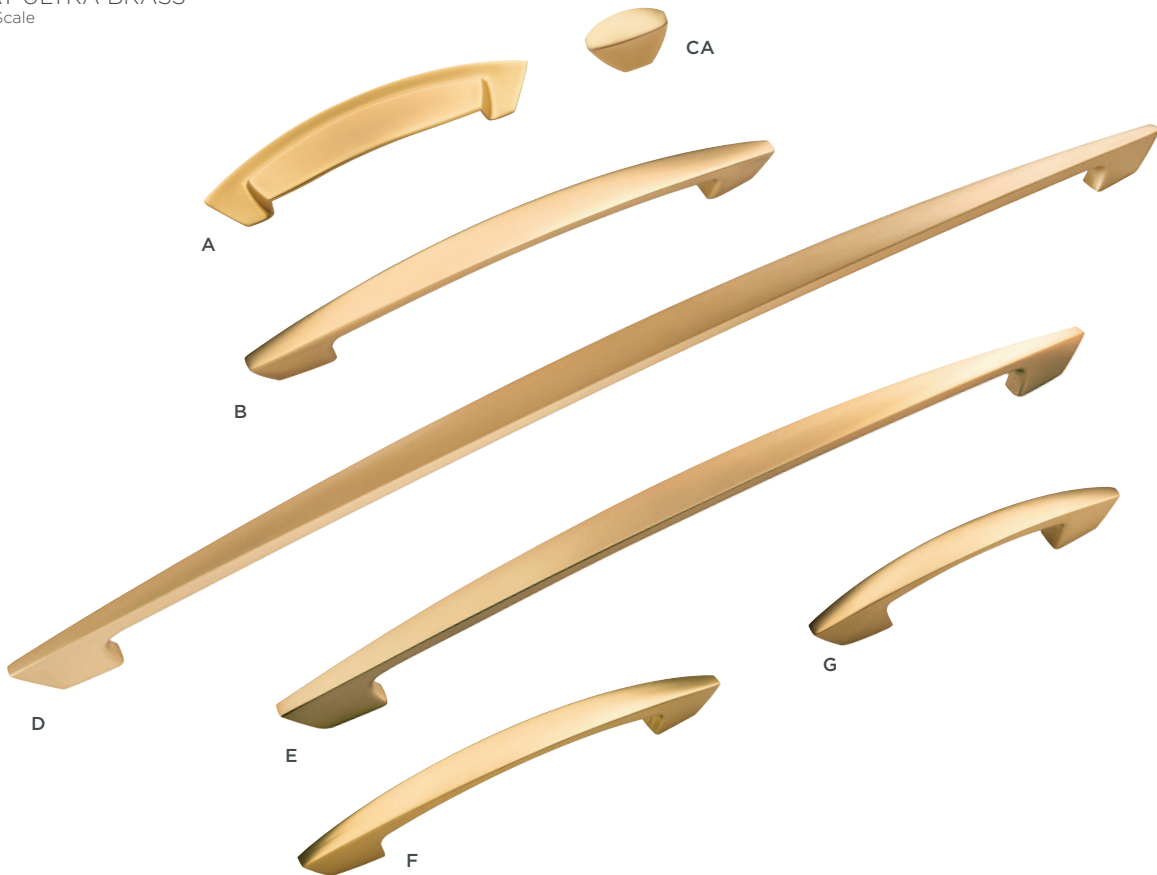

# WISTERIA

	PRODUCT SPECIFICATIONS					PART NUMBER	FINISH CODE		
	C/C	L	W	P	B		Polished Nickel	Satin Nickel	Refined Bronze
<b>A</b>	3"	3-3/4"	5/16"	1-1/16"	-	HH74551-	14	SN	RB
<b>B</b>	96mm	4-5/8"	3/8"	1-1/16"	-	HH74636-	14	SN	RB
<b>C</b>	128mm	6"	3/8"	1-1/16"	-	HH74632-	14	SN	RB
<b>D</b>	3" & 96mm	5-3/4"	1-1/16"	13/16"	-	HH74671-	14	SN	RB
<b>E</b>	-	1-7/16"	11/16"	1"	1/2" x 3/8"	HH74641-	14	SN	RB
<b>F</b>	-	1-3/4"	3/4"	1"	1/2" x 3/8"	HH74674-	14	SN	RB

Record the "Part Number" including the hyphen followed by the "Finish Code." Example: HH075422-VB

## POLISHED NICKEL 54% Scale

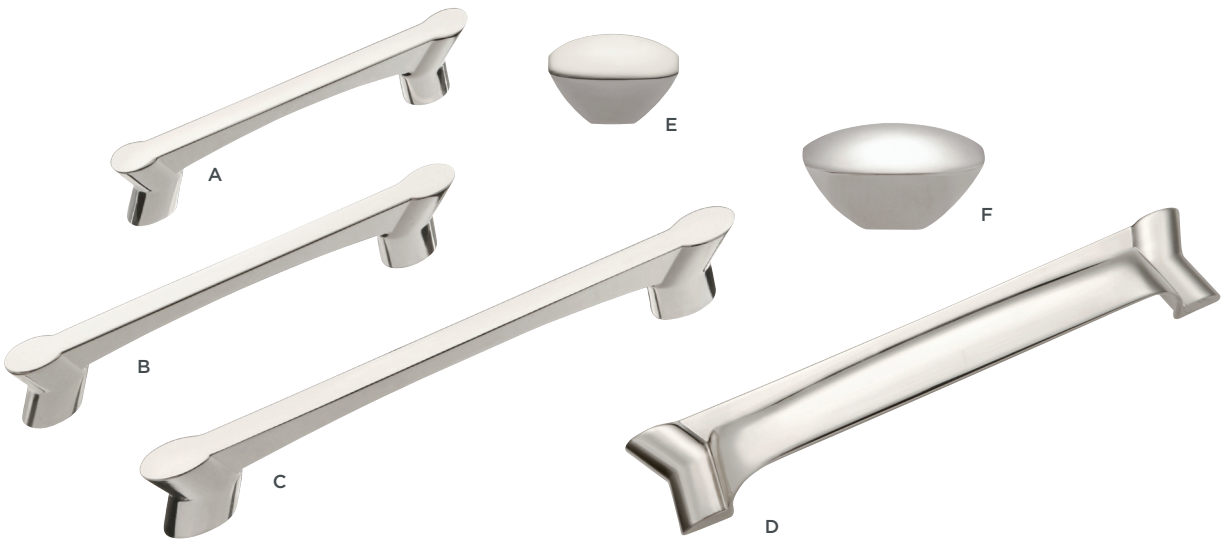

## SATIN NICKEL 54% Scale

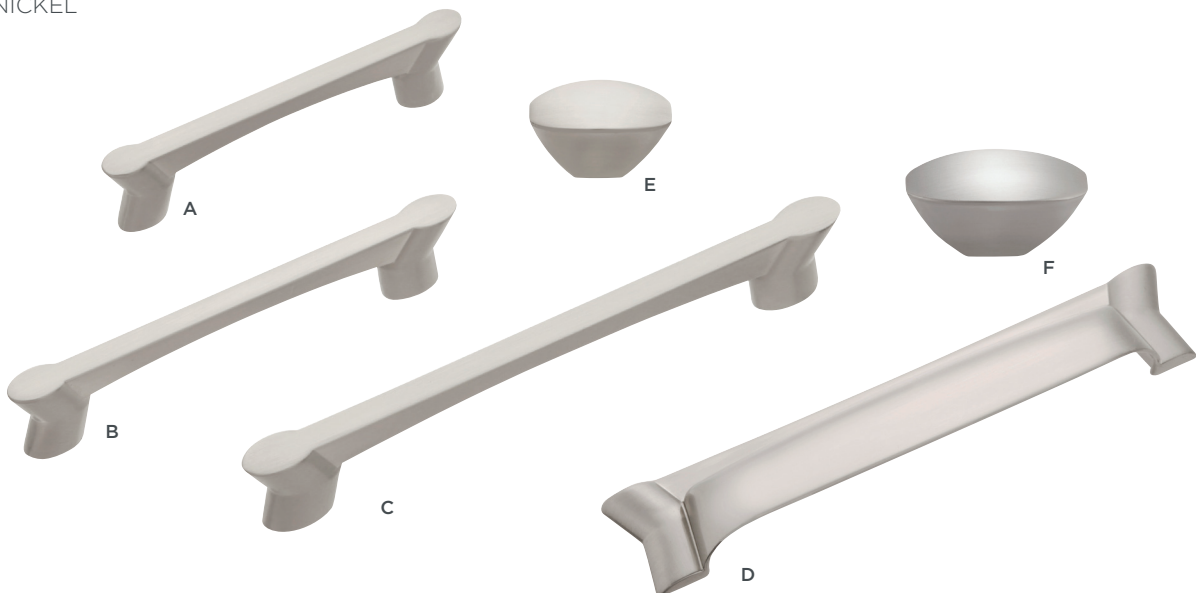

REFINED BRONZE  
54% Scale

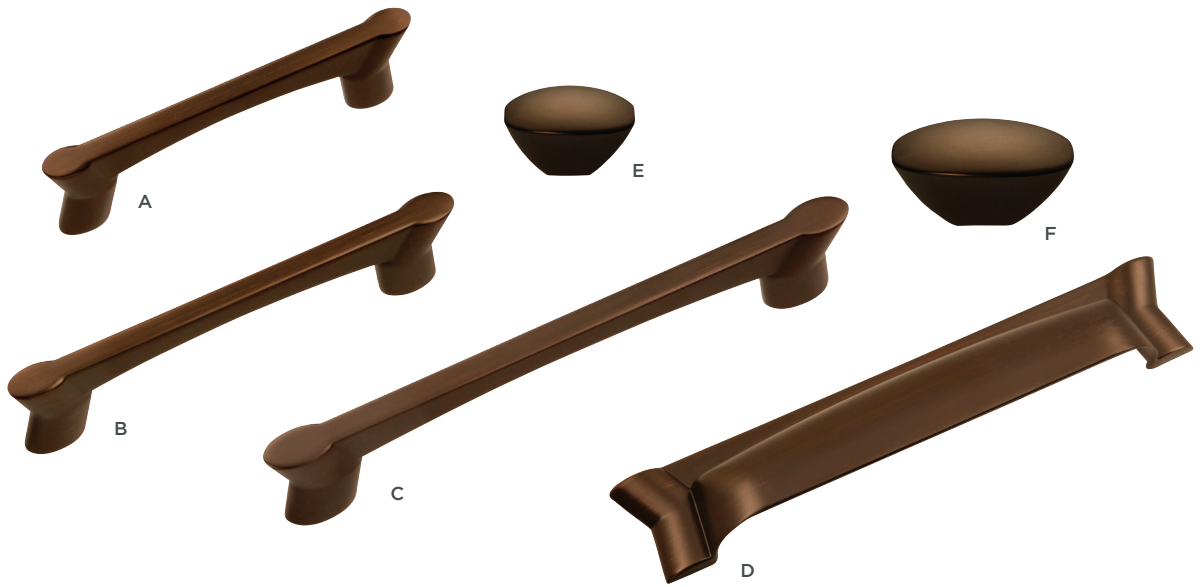

---

# CONTEMPORARY SELECTIONS

Clean lines, geometric silhouettes, and contrasting forms in finishes that work well on a neutral palette.

PRODUCT SPECIFICATIONS						PART NUMBER	FINISH CODE	
C/C	L	W	P	D	B		Satin Nickel	Vintage Bronze
<b>A</b>	-	-	15/16"	1-1/4"	5/16"	P3594-	SN	VB
<b>B</b>	3"	3-3/8"	7/16"	1"	-	P3595-	SN	VB

Record the "Part Number" including the hyphen followed by the "Finish Code." Example: HH075422-VB

SATIN NICKEL  
54% Scale

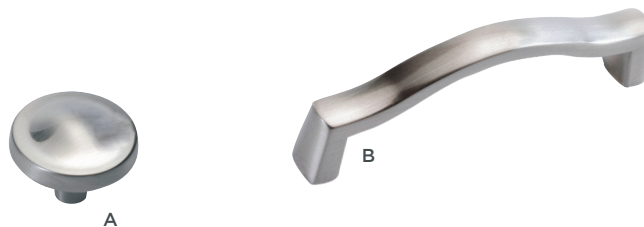

VINTAGE BRONZE  
54% Scale

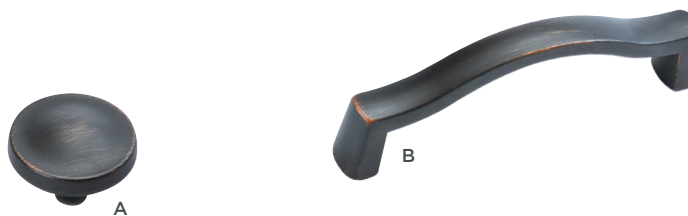

# AUSTERE

PRODUCT SPECIFICATIONS					PART NUMBER	FINISH CODE	Quantity
C/C	L	W	P			Aluminum	
<b>A</b>	1"	2"	3/8"	5/8"	C02H075744-	AL	Sold in Pairs
<b>B</b>	10-3/8"	14-13/16"	3/8"	5/8"	C02H075745-	AL	Sold in Pairs
<b>C</b>	13-3/8"	17-13/16"	3/8"	5/8"	C02H075746-	AL	Sold in Pairs
<b>D</b>	19-3/8"	23-13/16"	3/8"	5/8"	C02H075747-	AL	Sold in Pairs
<b>E</b>	25-3/8"	29-13/16"	3/8"	5/8"	C02H075748-	AL	Sold in Pairs
<b>F</b>	31-3/8"	35-13/16"	3/8"	5/8"	C02H075749-	AL	Sold in Pairs
<b>G</b>	33"	47"	3/8"	5/8"	CH075750-	AL	Sold Singularly

Record the "Part Number" including the hyphen followed by the "Finish Code." Example: HH075422-VB



ALUMINUM  
32% Scale

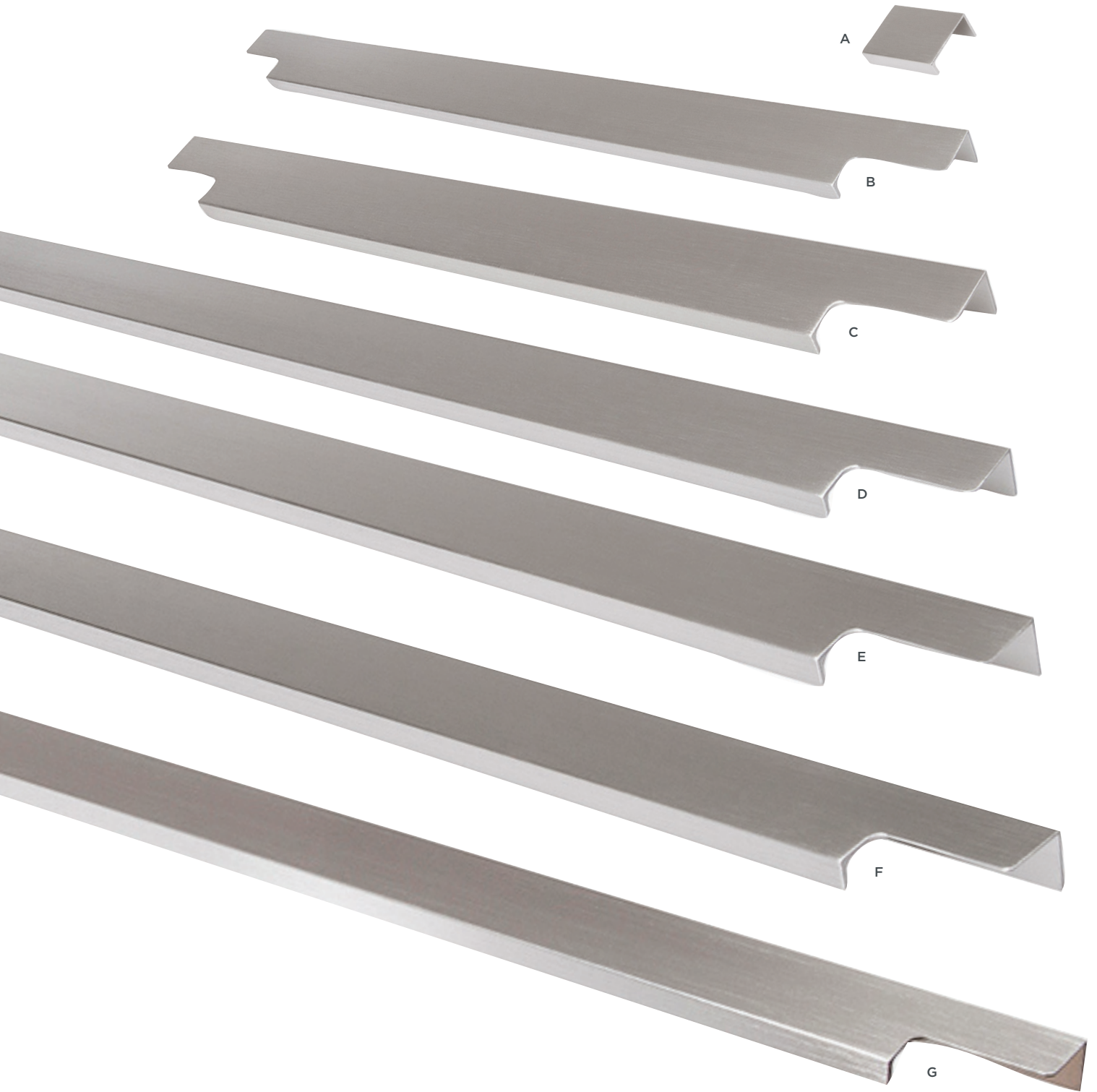

PRODUCT SPECIFICATIONS					PART NUMBER	FINISH CODE		
C/C	L	W	P	Chrome with Satin Pearl		Two-Tone Chrome	Frosted Chrome	
<b>A</b>	128mm	6"	5/8"	1"	P3699-	CHSP	-	-
<b>B</b>	6"	7-7/8"	5/8"	1-1/4"	P3701-	-	TCH	-
<b>C</b>	128mm	6-5/8"	1/2"	1-1/4"	P3697-	-	-	FCH

Record the "Part Number" including the hyphen followed by the "Finish Code." Example: HH075422-VB

## VARIOUS FINISHES

54% Scale





PRODUCT SPECIFICATIONS			PART NUMBER	FINISH CODE			
L	W	P		Satin Nickel	Windover Antique	Dark Antique Copper	
A	2-1/8"	2"	9/16"	P3190-	SN	WOA	DAC

Record the "Part Number" including the hyphen followed by the "Finish Code." Example: HH075422-VB

**SATIN NICKEL**  
54% Scale



A

**WINDOVER ANTIQUE**  
54% Scale



A

**DARK ANTIQUE COPPER**  
54% Scale



A



@simpleredesign

# EURO-CONTEMPORARY

	PRODUCT SPECIFICATIONS					PART NUMBER	FINISH CODE					
	C/C	L	W	P	B		Chrome	Satin Nickel	Stainless Steel	Windsor Antique	Oil-Rubbed Bronze Highlighted	Matte Black
<b>A</b>	-	1-1/2"	1-1/2"	1-3/16"	1-1/8" SQ.	P2163-	CH	SN	SS	-	OBH	-
<b>B</b>	-	1-1/4"	1-1/4"	1-1/4"	1-1/4" SQ.	P3181-	CH	SN	SS	WOA	OBH	MB
<b>C</b>	4"	7"	3/4"	1"	-	P2164-	-	SN	SS	-	OBH	-
<b>D</b>	128mm	9"	7/8"	1"	-	P2165-	-	SN	-	-	OBH	-
<b>E</b>	12" AP*	17-1/2"	1-1/16"	1-1/8"	-	P2167-	-	SN	-	-	-	-
<b>F</b>	18" AP*	23-7/8"	1-1/8"	1-3/8"	-	P2168-	-	SN	-	-	-	-
<b>G</b>	8" AP*	13"	7/8"	1-1/8"	-	P2166-	-	SN	-	-	-	-

Record the "Part Number" including the hyphen followed by the "Finish Code." Example: HH075422-VB  
 AP\* = Appliance Pull

## STAINLESS STEEL 54% Scale



## CHROME 54% Scale



### MATCHING HOOKS AVAILABLE

See page 193 for specs and finish options. Not to scale.

# EURO-CONTEMPORARY

SATIN NICKEL  
32% Scale



# EURO-CONTEMPORARY

	PRODUCT SPECIFICATIONS					PART NUMBER	FINISH CODE					
	C/C	L	W	P	B		Chrome	Satin Nickel	Stainless Steel	Windoever Antique	Oil-Rubbed Bronze Highlighted	Matte Black
<b>A</b>	-	1-1/2"	1-1/2"	1-3/16"	1-1/8" SQ.	P2163-	CH	SN	SS	-	OBH	-
<b>B</b>	-	1-1/4"	1-1/4"	1-1/4"	1-1/4" SQ.	P3181-	CH	SN	SS	WOA	OBH	MB
<b>C</b>	4"	7"	3/4"	1"	-	P2164-	-	SN	SS	-	OBH	-
<b>D</b>	128mm	9"	7/8"	1"	-	P2165-	-	SN	-	-	OBH	-
<b>E</b>	12"	17-1/2"	1-1/16"	1-1/8"	-	P2167-	-	SN	-	-	-	-
<b>F</b>	18"	23-7/8"	1-1/8"	1-3/8"	-	P2168-	-	SN	-	-	-	-
<b>G</b>	8"	13"	7/8"	1-1/8"	-	P2166-	-	SN	-	-	-	-

Record the "Part Number" including the hyphen followed by the "Finish Code." Example: HH075422-VB

**WINDOEVER ANTIQUE**  
54% Scale



**MATTE BLACK**  
54% Scale



**OIL-RUBBED BRONZE HIGHLIGHTED**  
54% Scale

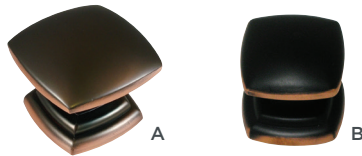

PRODUCT SPECIFICATIONS						PART NUMBER	FINISH CODE	
	C/C	L	W	P	B		Satin Nickel	Vintage Bronze
<b>A</b>	3"	5"	3/4"	1"	-	P3591-	SN	VB
<b>B</b>	-	1-1/4"	3/4"	15/16"	5/16"	P3590-	SN	VB

Record the "Part Number" including the hyphen followed by the "Finish Code." Example: HH075422-VB

SATIN NICKEL  
54% Scale



VINTAGE BRONZE  
54% Scale



# LOFT

PRODUCT SPECIFICATIONS							PART NUMBER	FINISH CODE	
C/C	L	W	P	D	B	Satin Nickel w/ Black		Satin Nickel w/ White Matte	
<b>A</b>	-	-	-	7/8"	1"	5/16"	P3440-	SNB	SNWM
<b>B</b>	3"	3-3/8"	3/8"	1"	-	-	P3441-	SNB	SNWM

Record the "Part Number" including the hyphen followed by the "Finish Code." Example: HH075422-VB

SATIN NICKEL W/ BLACK  
54% Scale

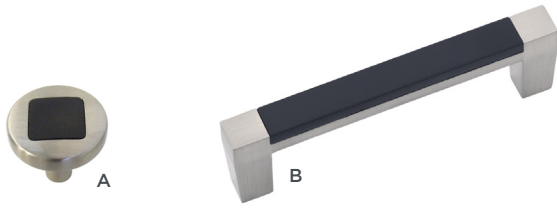

SATIN NICKEL W/ WHITE MATTE  
54% Scale

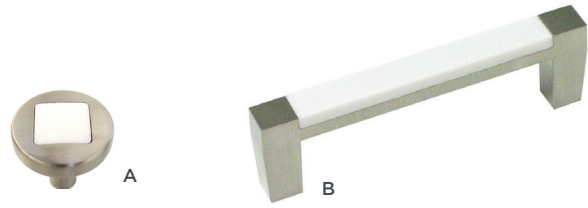

CONTEMPORARY SELECTIONS



	PRODUCT SPECIFICATIONS						PART NUMBER	FINISH CODE		
	C/C	L	W	P	D	B		Satin Nickel	Vintage Bronze	Matte Black
<b>A</b>	3"	4-1/8"	9/16"	1"	-	-	P3448-	SN	VB	MB
<b>B</b>	3" & 96mm	4"	7/16"	1"	-	-	P3447-	SN	VB	MB
<b>C</b>	-	-	-	1"	1"	5/8"	P2712-	-	-	MB

Record the "Part Number" including the hyphen followed by the "Finish Code." Example: HH075422-VB

SATIN NICKEL  
54% Scale



VINTAGE BRONZE  
54% Scale



MATTE BLACK  
54% Scale



MATCHING HOOKS AVAILABLE

See page 193 for specs and finish options. Not to scale.



# METROPOLIS

	PRODUCT SPECIFICATIONS						PART NUMBER	FINISH CODE					
	C/C	L	W	P	D	B		Chrome	Satin Nickel	Stainless Steel	Ultra Brass	Polished Brass	Matte Black
<b>A</b>	96mm	5-1/2"	1/2"	3/4"	-	-	P7522-	-	SN	-	-	-	-
<b>B</b>	96mm	5-1/2"	11/16"	1-5/16"	-	-	P2161-	-	SN	-	-	-	-
<b>C</b>	128mm	7-7/16"	11/16"	1-5/16"	-	-	P2162-	-	SN	-	-	-	-
<b>D</b>	3"	3-3/8"	5/8"	7/8"	-	-	P324-	CH	SN	SS	-	-	-
<b>E</b>	3"	4-1/8"	7/8"	1"	-	-	PA0222-	-	SN	-	-	-	-
<b>F</b>	128mm	6-1/4"	13/16"	1-1/16"	-	-	P3616-	-	SN	-	-	-	-
<b>G</b>	1"	1-5/8"	3/4"	7/8"	-	1-5/16" x 3/8"	P7523-	-	SN	-	-	-	-
<b>H</b>	-	1-3/4"	3/4"	13/16"	-	1-5/16" x 3/8"	P7524-	-	SN	-	-	-	-
<b>I</b>	-	1-9/16"	1/2"	15/16"	-	3/4"	PA0211-	-	SN	-	-	-	MB
<b>J</b>	32mm	1-9/16"	7/16"	1"	-	-	P2623	-	SN	-	-	-	MB
<b>K</b>	-	-	-	1-1/4"	1"	1/2"	PA0213-	-	SN	-	-	-	MB
<b>L</b>	-	-	-	1-1/16"	1-1/4"	9/16"	P2911-	-	SN	-	-	-	MB
<b>M</b>	-	-	-	1-1/8"	1"	1-3/4"	K65-	-	SN	-	-	-	-
<b>N</b>	64mm	3"	7/16"	1-1/8"	-	-	P2622-	-	SN	-	-	-	-
<b>O</b>	7/8"	1-9/16"	9/16"	1"	-	-	P3043	-	SN	-	-	-	-
<b>P</b>	1-1/2"	4-3/4"	9/16"	1"	-	-	P3042	-	SN	-	-	-	-
<b>Q</b>	64mm	3-7/8"	3/8"	7/8"	-	-	P2921-	-	SN	-	-	-	MB
<b>R</b>	96mm	5-1/8"	1/4"	1"	-	-	P2922-	-	SN	-	-	-	MB
<b>S</b>	96mm	5"	11/16"	1-1/8"	-	-	PA0223-	-	SN	-	-	-	MB
<b>T</b>	128mm	6-1/4"	11/16"	1-1/8"	-	-	P2925-	-	SN	-	-	-	MB
<b>U</b>	96mm	4-3/4"	1/2"	1"	-	-	PA0221-	-	SN	-	-	-	-
<b>V</b>	128mm	6-3/8"	1/2"	1-1/8"	-	-	P3221-	-	SN	-	-	-	-
<b>W</b>	160mm	8-1/8"	1/2"	1-1/4"	-	-	P3222-	-	SN	-	-	-	-
<b>AA</b>	192mm	9"	9/16"	1-1/8"	-	-	P3040-	-	SN	-	-	-	-
<b>AB</b>	-	1-7/16"	3/4"	1"	-	5/8" x 3/8"	P208-	26	-	SS	UB	-	-
<b>X</b>	-	-	-	3/4"	1-1/2"	9/16"	P113-	26	-	-	-	-	-
<b>AC</b>	-	-	-	3/4"	1-1/16"	3/8"	P111-	26	-	-	-	-	-
<b>Y</b>	-	-	-	7/8"	1-3/16"	5/16"	P213-	26	-	-	-	-	-
<b>Z</b>	3"	3-15/16"	7/16"	13/16"	-	-	P115-	26	-	-	-	-	-
<b>AD</b>	96mm	4-3/8"	3/8"	1"	-	-	P6088-	26	-	-	-	-	-
<b>XX</b>	-	-	-	3/4"	1-1/2"	9/16"	P114-	-	-	-	-	3	-
<b>YY</b>	-	-	-	7/8"	1-3/16"	5/16"	P214-	-	-	-	-	3	-
<b>ZZ</b>	3"	3-15/16"	7/16"	13/16"	-	-	P116-	-	-	-	-	3	-

Record the "Part Number" including the hyphen followed by the "Finish Code." Example: HH075422-VB



SATIN NICKEL  
54% Scale



# METROPOLIS

SATIN NICKEL  
54% Scale

SEE TABLE ON PG. 48



## CHROME 54% Scale

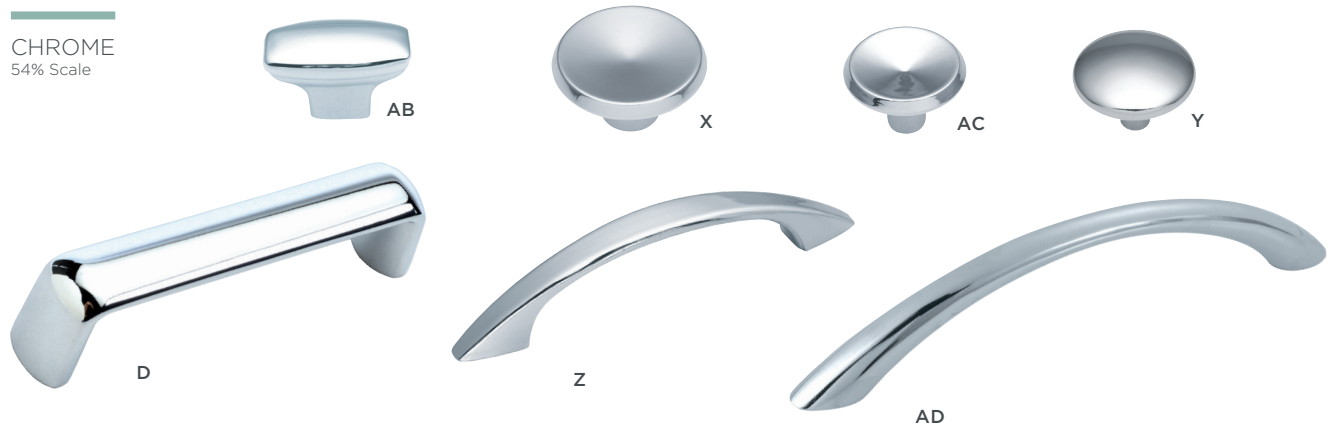

## STAINLESS STEEL 54% Scale

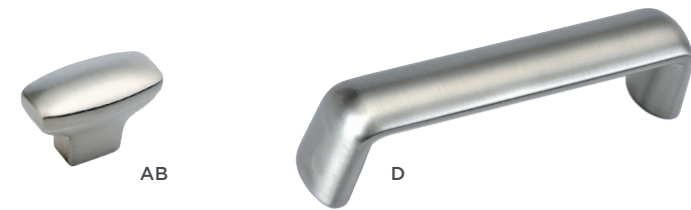

## ULTRA BRASS 54% Scale



## POLISHED BRASS 54% Scale



## MATTE BLACK 54% Scale



# MITO

PRODUCT SPECIFICATIONS					PART NUMBER	FINISH CODE	
C/C	L	W	P			Satin Pearl	Flat Nickel
<b>A</b>	160mm	7-1/16"	5/8"	1-3/8"	P3691-	SP	-
<b>B</b>	4-1/4"	5"	1/2"	1-3/16"	P3083-	-	FN

Record the "Part Number" including the hyphen followed by the "Finish Code." Example: HH075422-VB

**SATIN PEARL**  
54% Scale

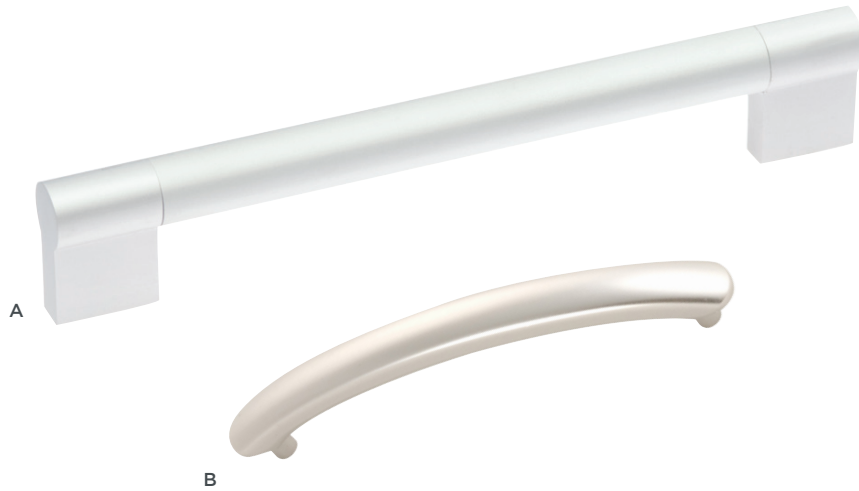

**FLAT NICKEL**  
54% Scale

# RALEIGH

PRODUCT SPECIFICATIONS						PART NUMBER	FINISH CODE			
C/C	L	W	P	B			Polished Nickel	Satin Nickel	Windover Antique	Oil-Rubbed Bronze Highlighted
<b>A</b>	-	1-3/8"	1-1/8"	1"	7/16" SQ.	P3123-	14	SN	-	-
<b>B</b>	5"	5-3/4"	5/8"	1-3/16"	-	P3111-	14	SN	WOA	OBH
<b>C</b>	8"	9-1/4"	5/8"	1-1/4"	-	P3117-	14	SN	-	-

Record the "Part Number" including the hyphen followed by the "Finish Code." Example: HH075422-VB

**POLISHED NICKEL**  
54% Scale



SATIN NICKEL  
54% Scale



WINDOVER ANTIQUE  
54% Scale



OIL-RUBBED BRONZE HIGHLIGHTED  
54% Scale



# RICHMOND

PRODUCT SPECIFICATIONS					PART NUMBER	FINISH CODE				
C/C	L	W	P	B		Polished Nickel	Satin Nickel	Windover Antique	Oil-Rubbed Bronze Highlighted	
A	-	1-1/2"	11/16"	1-1/16"	13/16" x 9/16"	P3125-	14	SN	-	-
B	3"	4-9/16"	1/2"	15/16"	-	P3113-	14	SN	WOA	OBH
C	8"	9-1/2"	9/16"	1"	-	P3119-	14	SN	-	-

Record the "Part Number" including the hyphen followed by the "Finish Code." Example: HH075422-VB

## POLISHED NICKEL 54% Scale

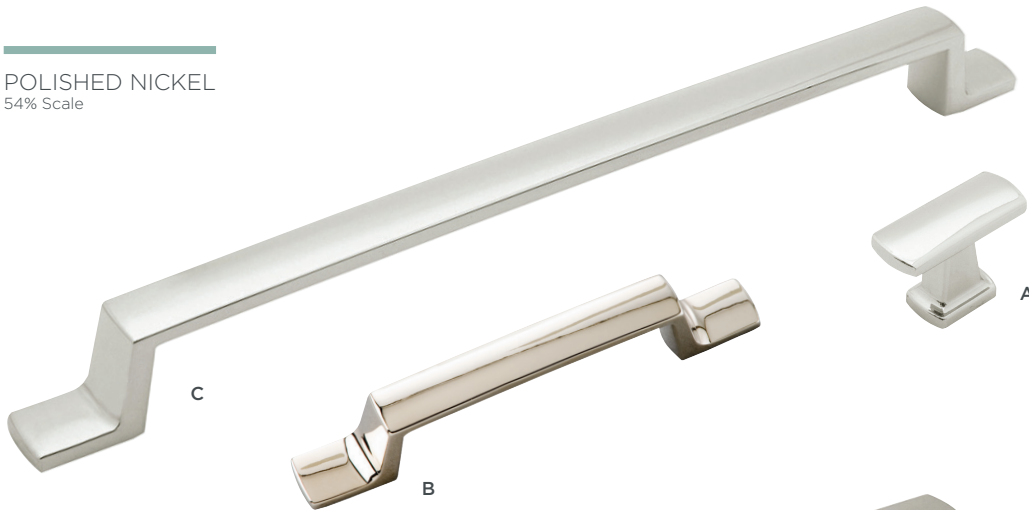

## SATIN NICKEL 54% Scale

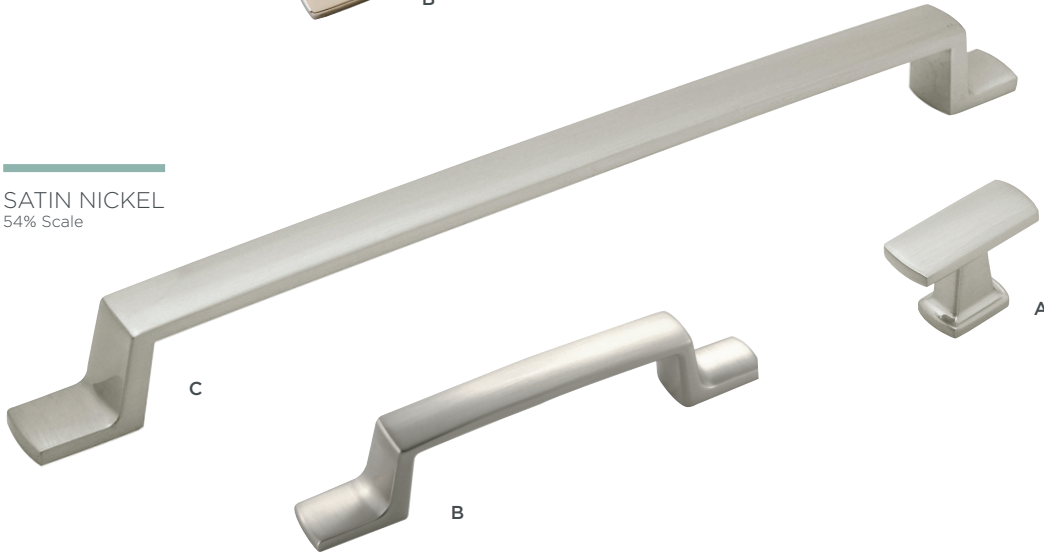

## WINDOVER ANTIQUE 54% Scale



## OIL-RUBBED BRONZE HIGHLIGHTED 54% Scale

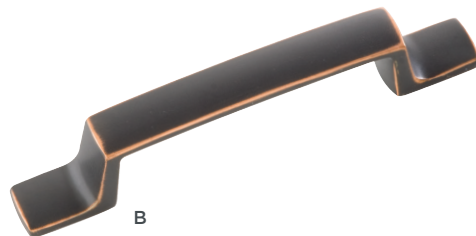

	PRODUCT SPECIFICATIONS				PART NUMBER	FINISH CODE		
	C/C	L	W	P		Polished Nickel	Satin Nickel	Oil-Rubbed Bronze Highlighted
<b>A</b>	96mm	4-1/8"	1/2"	1-1/16"	P3114-	14	SN	OBH
<b>B</b>	96mm	4-1/4"	7/16"	1-1/16"	P3112-	14	SN	OBH
<b>C</b>	8"	8-1/2"	1/2"	1"	P3118-	14	SN	-

Record the "Part Number" including the hyphen followed by the "Finish Code." Example: HH075422-VB

**POLISHED NICKEL**  
54% Scale

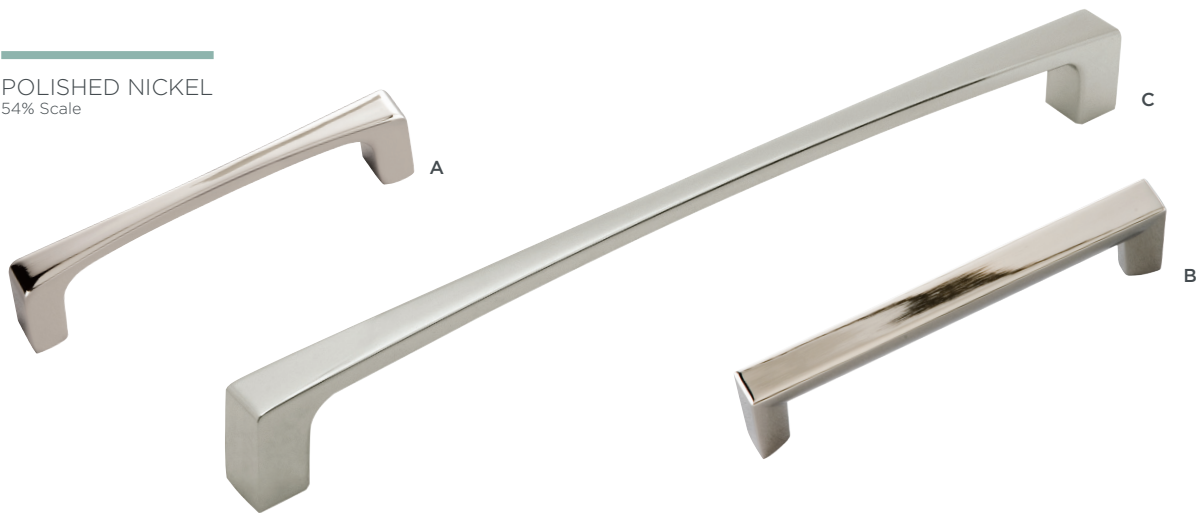

**SATIN NICKEL**  
54% Scale

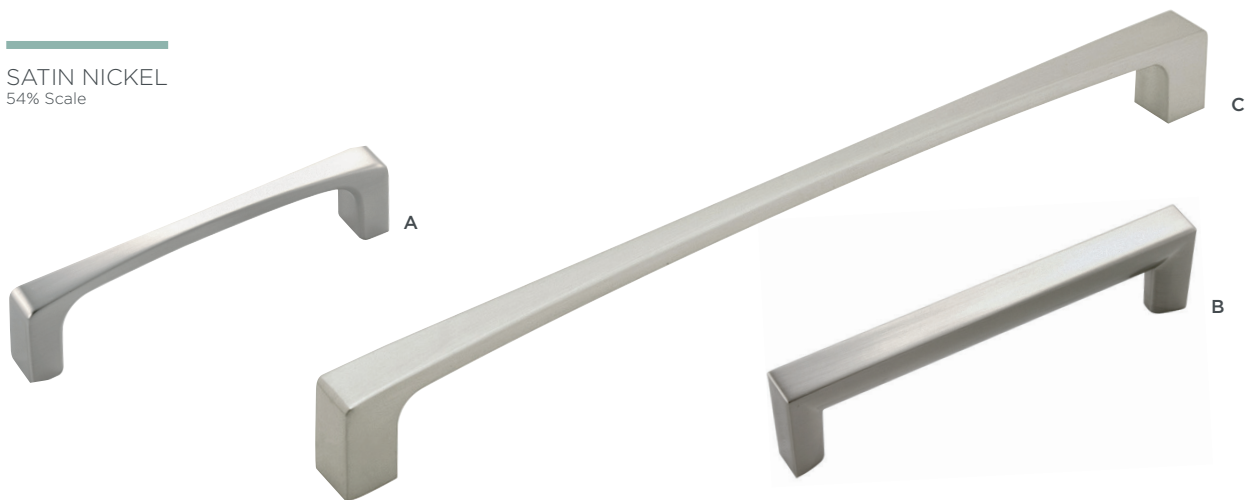

**OIL-RUBBED BRONZE HIGHLIGHTED**  
54% Scale

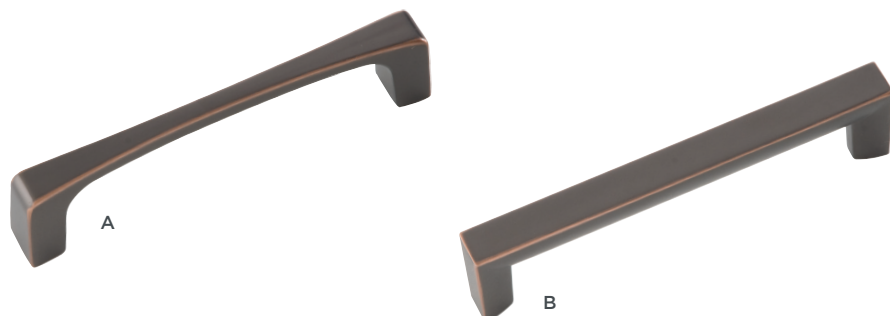

# ROCKFORD

	PRODUCT SPECIFICATIONS				PART NUMBER	FINISH CODE		
	C/C	L	W	P*		Polished Nickel	Satin Nickel	Oil-Rubbed Bronze Highlighted
<b>A</b>	160mm	7"	1"	1"*	HH074888-	14	SN	OBH
<b>B</b>	1"	1-3/4"	1"	1"*	HH09747-	14	SN	OBH

Record the "Part Number" including the hyphen followed by the "Finish Code." Example: HH075422-VB  
 \*Assumes standard cabinet thickness of 3/4"

## POLISHED NICKEL

54% Scale



A



B

## SATIN NICKEL

54% Scale



A



B

## OIL-RUBBED BRONZE HIGHLIGHTED

54% Scale

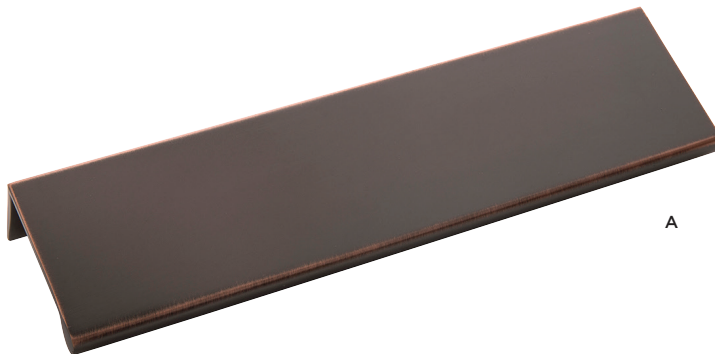

A

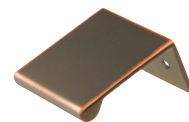

B



	PRODUCT SPECIFICATIONS						PART NUMBER	FINISH CODE	
	C/C	L	W	P	D	B		Satin Nickel	Vintage Bronze
<b>A</b>	-	-	-	15/16"	1-1/4"	5/16"	P3592-	SN	VB
<b>B</b>	3"	4-13/16"	7/16"	1"	-	-	P3593-	SN	VB

Record the "Part Number" including the hyphen followed by the "Finish Code." Example: HH075422-VB

## SATIN NICKEL

54% Scale



## VINTAGE BRONZE

54% Scale

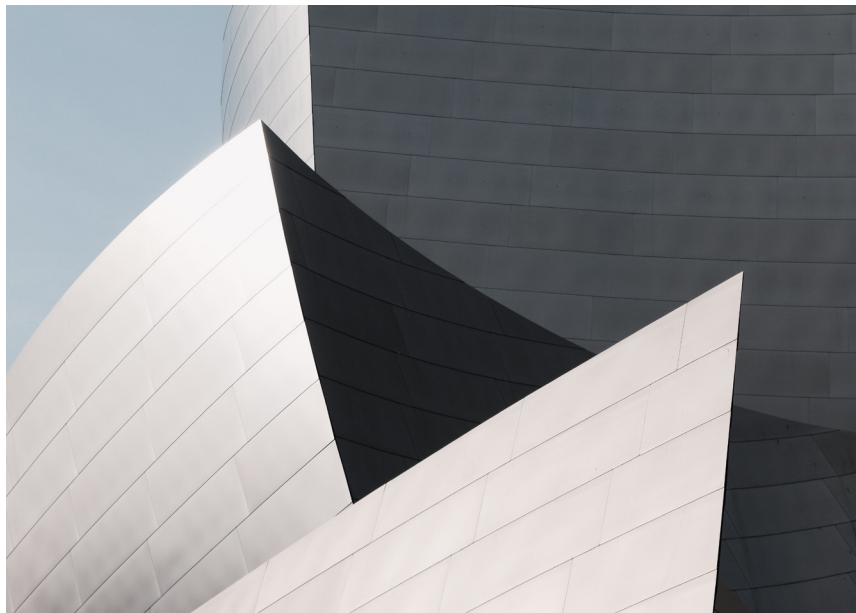

# SWOOP

	PRODUCT SPECIFICATIONS						PART NUMBER	FINISH CODE	
	C/C	L	W	P	D	B		Chrome	Stainless Steel
<b>A</b>	-	1-1/4"	1-1/4"	1-1/4"	-	1-1/4" x 7/16"	P3330-	CH	SS
<b>B</b>	3", 96mm & 128mm	5-13/16"	1-3/16"	1-5/16"	-	-	P3332-	-	SS
<b>C</b>	160mm	7-3/4"	1-3/16"	1-5/16"	-	-	P3331-	-	SS
<b>D</b>	128mm	5-13/16"	1-1/8"	1-1/4"	-	-	P3333-	-	SS
<b>E</b>	3" & 96mm	4-3/16"	1-1/16"	1-1/4"	-	-	P3334-	-	SS

Record the "Part Number" including the hyphen followed by the "Finish Code." Example: HH075422-VB

**CHROME**  
54% Scale

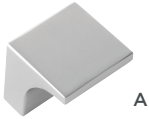

**STAINLESS STEEL**  
54% Scale

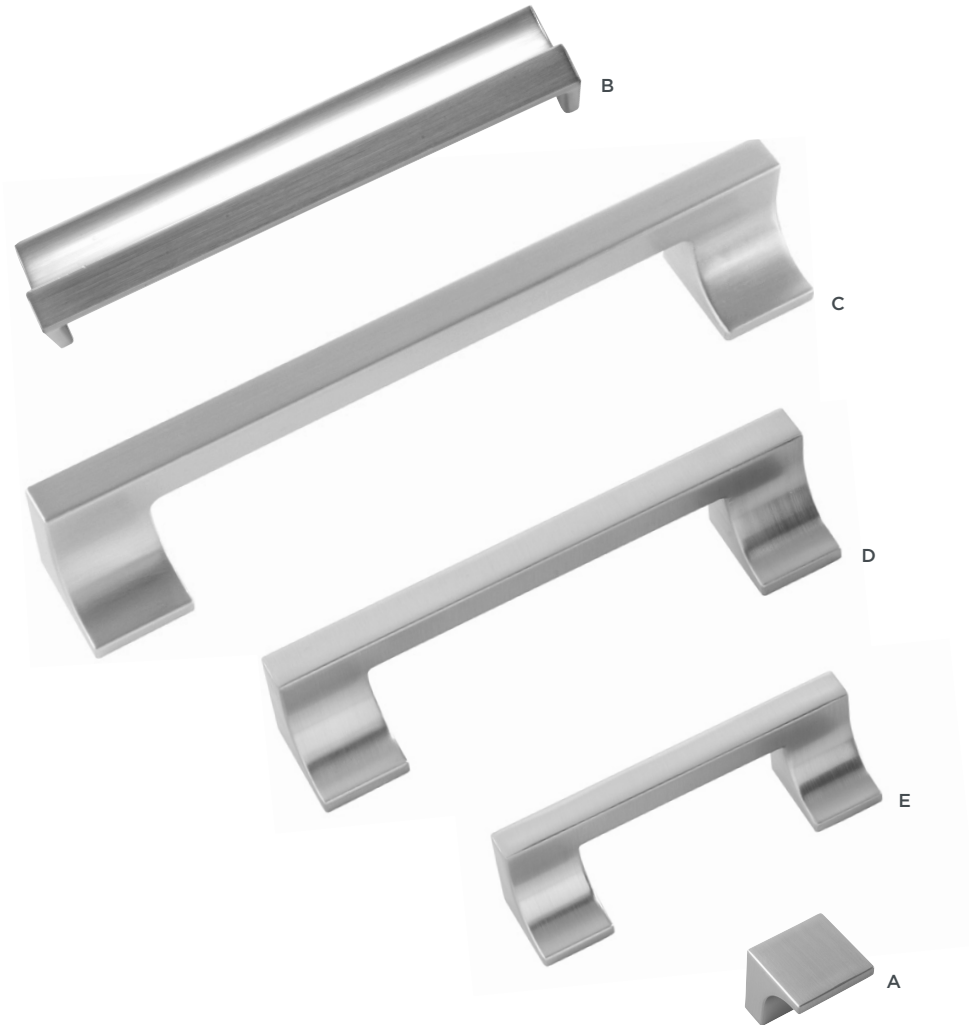

	PRODUCT SPECIFICATIONS						PART NUMBER			
	C/C	L	W	P	D	B		White	Black	Light Almond
<b>A</b>	-	-	-	1-1/8"	1-1/2"	5/8"	P814-	W	-	-
<b>B</b>	3"	3-1/4"	3/8"	1-3/8"	-	-	P813-	W	-	-
<b>C</b>	96mm	4"	3/8"	1-3/8"	-	-	P864-	W	-	-
<b>D</b>	-	-	-	1-1/8"	1-1/2"	5/8"	P818-	-	BL	-
<b>E</b>	3"	3-1/4"	3/8"	1-3/8"	-	-	P817-	-	BL	-
<b>F</b>	96mm	4"	3/8"	1-3/8"	-	-	P867-	-	BL	-
<b>G</b>	-	-	-	1-1/8"	1-1/2"	5/8"	P865-	-	-	LAD
<b>H</b>	3"	3-1/4"	3/8"	1-3/8"	-	-	P877-	-	-	LAD

Record the "Part Number" including the hyphen followed by the "Finish Code." Example: HH075422-VB

## PLASTIC

54% Scale



# WIRE PULLS

	PRODUCT SPECIFICATIONS				PART NUMBER	FINISH CODE			
	C/C	L	W	P		Satin Nickel	Satin Aluminum	White	Black
<b>A</b>	3"	3-5/16"	5/16"	1-1/4"	PW553-	SN	-	-	-
<b>AA</b>	3"	3-5/16"	5/16"	1-1/4"	PW353-	-	-	24	22
<b>B</b>	3-1/2"	3-13/16"	5/16"	1-1/4"	PW554-	SN	-	-	-
<b>BB</b>	3-1/2"	3-13/16"	5/16"	1-1/4"	PW354-	-	-	24	22
<b>C</b>	96mm	4-1/16"	5/16"	1-1/4"	PW596-	SN	-	-	-
<b>CC</b>	96mm	4-1/16"	5/16"	1-1/4"	PW396-	-	-	-	22
<b>D</b>	4"	4-5/16"	5/16"	1-1/4"	PW555-	SN	-	-	-
<b>DD</b>	4"	4-5/16"	5/16"	1-1/4"	PW355-	-	28	24	22

Record the "Part Number" including the hyphen followed by the "Finish Code." Example: HH075422-VB

## SATIN NICKEL

Steel Material  
54% Scale

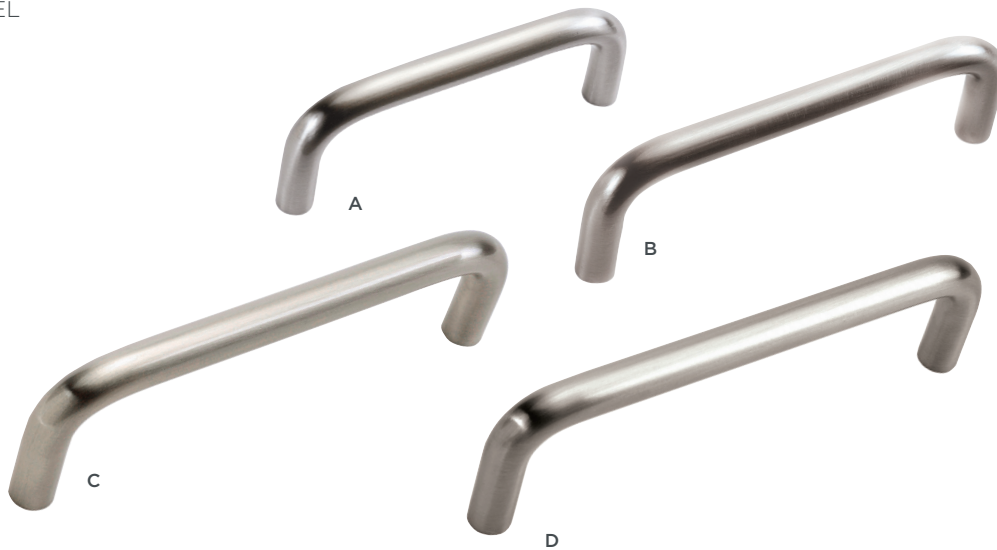

## SATIN ALUMINUM

Aluminum Material  
54% Scale



WHITE  
Brass Material  
54% Scale

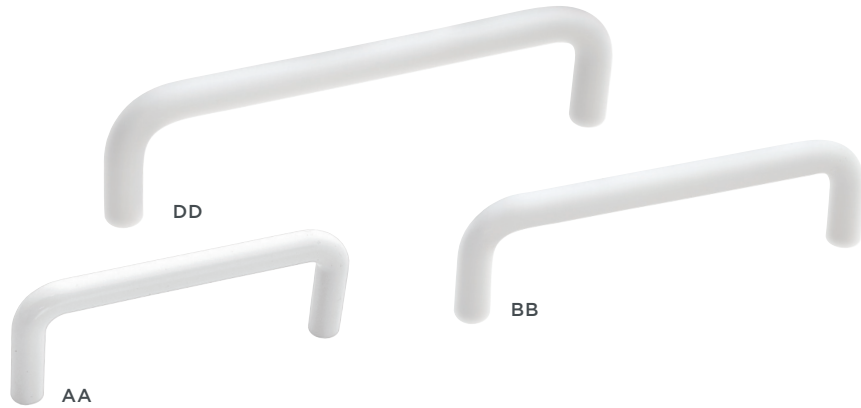

BLACK  
Brass Material  
54% Scale

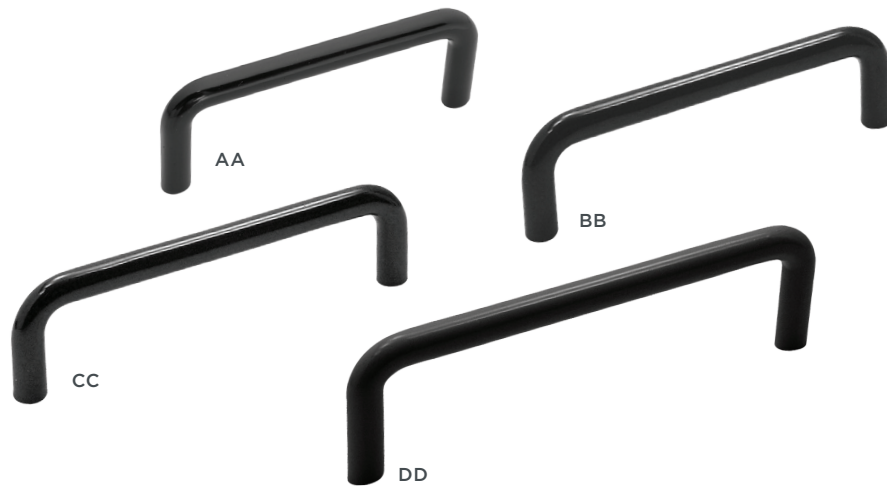

---

# TRANSITIONAL

A blend of traditional and contemporary styles: classic shapes are softened but not stark; old and new are combined for a fresh new look.



# AMERICAN DINER

	PRODUCT SPECIFICATIONS						PART NUMBER	FINISH CODE					
	C/C	L	W	P	D	B		Chrome	Satin Nickel	Stainless Steel	Brushed Golden Brass	Vintage Bronze	Black Nickel
<b>A</b>	-	-	-	1"	1"	7/8"	P2140-	CH	SN	SS	BGB	VB	-
<b>B</b>	-	-	-	1-1/8"	1-3/8"	1-3/16"	P2142-	CH	SN	SS	BGB	VB	BLN
<b>C</b>	96mm	5"	7/8"	1-1/16"	-	-	P2141-	CH	SN	SS	BGB	VB	BLN
<b>D</b>	3"	3-7/8"	11/16"	1-1/16"	-	-	P2143-	CH	SN	SS	BGB	VB	BLN
<b>E</b>	128mm	6-1/8"	7/8"	1-1/16"	-	-	P2149-	CH	SN	SS	BGB	VB	-
<b>F</b>	3" & 96mm	4-5/8"	1-1/2"	1"	-	-	P2144-	CH	SN	SS	BGB	-	-
<b>G</b>	192mm	8-3/4"	7/8"	1-1/8"	-	-	P2157-	CH	SN	-	BGB	VB	-
<b>H</b>	12"	13-1/4"	7/8"	1-1/8"	-	-	P2159-	CH	SN	-	BGB	VB	-
<b>I</b>	224mm	10"	7/8"	1-1/8"	-	-	P2158-	CH	SN	-	BGB	VB	-
<b>J</b>	160mm	7-1/2"	7/8"	1-1/16"	-	-	P2156-	CH	SN	-	BGB	VB	-
<b>K</b>	12" AP*	13-5/8"	1-1/4"	1-1/2"	-	-	P2147-	-	SN	SS	-	-	-
<b>L</b>	18" AP*	20-1/8"	1-1/2"	1-7/8"	-	-	P2148-	-	SN	SS	-	-	-
<b>M</b>	8" AP*	9-5/8"	1-1/4"	1-1/2"	-	-	P2146-	-	SN	SS	-	-	-

Record the "Part Number" including the hyphen followed by the "Finish Code." Example: HH075422-VB  
 AP\* = Appliance Pull

## CHROME 54% Scale







MATCHING HOOKS AVAILABLE

See page 188 for specs and finish options. Not to scale.



# AMERICAN DINER

	PRODUCT SPECIFICATIONS						PART NUMBER	FINISH CODE					
	C/C	L	W	P	D	B		Chrome	Satin Nickel	Stainless Steel	Brushed Golden Brass	Vintage Bronze	Black Nickel
<b>A</b>	-	-	-	1"	1"	7/8"	P2140-	CH	SN	SS	BGB	VB	-
<b>B</b>	-	-	-	1-1/8"	1-3/8"	1-3/16"	P2142-	CH	SN	SS	BGB	VB	BLN
<b>C</b>	96mm	5"	7/8"	1-1/16"	-	-	P2141-	CH	SN	SS	BGB	VB	BLN
<b>D</b>	3"	3-7/8"	11/16"	1-1/16"	-	-	P2143-	CH	SN	SS	BGB	VB	BLN
<b>E</b>	128mm	6-1/8"	7/8"	1-1/16"	-	-	P2149-	CH	SN	SS	BGB	VB	-
<b>F</b>	3" & 96mm	4-5/8"	1-1/2"	1"	-	-	P2144-	CH	SN	SS	BGB	-	-
<b>G</b>	192mm	8-3/4"	7/8"	1-1/8"	-	-	P2157-	CH	SN	-	BGB	VB	-
<b>H</b>	12"	13-1/4"	7/8"	1-1/8"	-	-	P2159-	CH	SN	-	BGB	VB	-
<b>I</b>	224mm	10"	7/8"	1-1/8"	-	-	P2158-	CH	SN	-	BGB	VB	-
<b>J</b>	160mm	7-1/2"	7/8"	1-1/16"	-	-	P2156-	CH	SN	-	BGB	VB	-
<b>K</b>	12" AP*	13-5/8"	1-1/4"	1-1/2"	-	-	P2147-	-	SN	SS	-	-	-
<b>L</b>	18" AP*	20-1/8"	1-1/2"	1-7/8"	-	-	P2148-	-	SN	SS	-	-	-
<b>M</b>	8" AP*	9-5/8"	1-1/4"	1-1/2"	-	-	P2146-	-	SN	SS	-	-	-

Record the "Part Number" including the hyphen followed by the "Finish Code." Example: HH075422-VB  
 AP\* = Appliance Pull

STAINLESS STEEL  
 32% Scale



SATIN NICKEL  
32% Scale



# AMERICAN DINER

	PRODUCT SPECIFICATIONS						PART NUMBER	FINISH CODE					
	C/C	L	W	P	D	B		Chrome	Satin Nickel	Stainless Steel	Brushed Golden Brass	Vintage Bronze	Black Nickel
<b>A</b>	-	-	-	1"	1"	7/8"	P2140-	CH	SN	SS	BGB	VB	-
<b>B</b>	-	-	-	1-1/8"	1-3/8"	1-3/16"	P2142-	CH	SN	SS	BGB	VB	BLN
<b>C</b>	96mm	5"	7/8"	1-1/16"	-	-	P2141-	CH	SN	SS	BGB	VB	BLN
<b>D</b>	3"	3-7/8"	11/16"	1-1/16"	-	-	P2143-	CH	SN	SS	BGB	VB	BLN
<b>E</b>	128mm	6-1/8"	7/8"	1-1/16"	-	-	P2149-	CH	SN	SS	BGB	VB	-
<b>F</b>	3" & 96mm	4-5/8"	1-1/2"	1"	-	-	P2144-	CH	SN	SS	BGB	-	-
<b>G</b>	192mm	8-3/4"	7/8"	1-1/8"	-	-	P2157-	CH	SN	-	BGB	VB	-
<b>H</b>	12"	13-1/4"	7/8"	1-1/8"	-	-	P2159-	CH	SN	-	BGB	VB	-
<b>I</b>	224mm	10"	7/8"	1-1/8"	-	-	P2158-	CH	SN	-	BGB	VB	-
<b>J</b>	160mm	7-1/2"	7/8"	1-1/16"	-	-	P2156-	CH	SN	-	BGB	VB	-
<b>K</b>	12" AP*	13-5/8"	1-1/4"	1-1/2"	-	-	P2147-	-	SN	SS	-	-	-
<b>L</b>	18" AP*	20-1/8"	1-1/2"	1-7/8"	-	-	P2148-	-	SN	SS	-	-	-
<b>M</b>	8" AP*	9-5/8"	1-1/4"	1-1/2"	-	-	P2146-	-	SN	SS	-	-	-

Record the "Part Number" including the hyphen followed by the "Finish Code." Example: HH075422-VB  
 AP\* = Appliance Pull

## BRUSHED GOLDEN BRASS 32% Scale

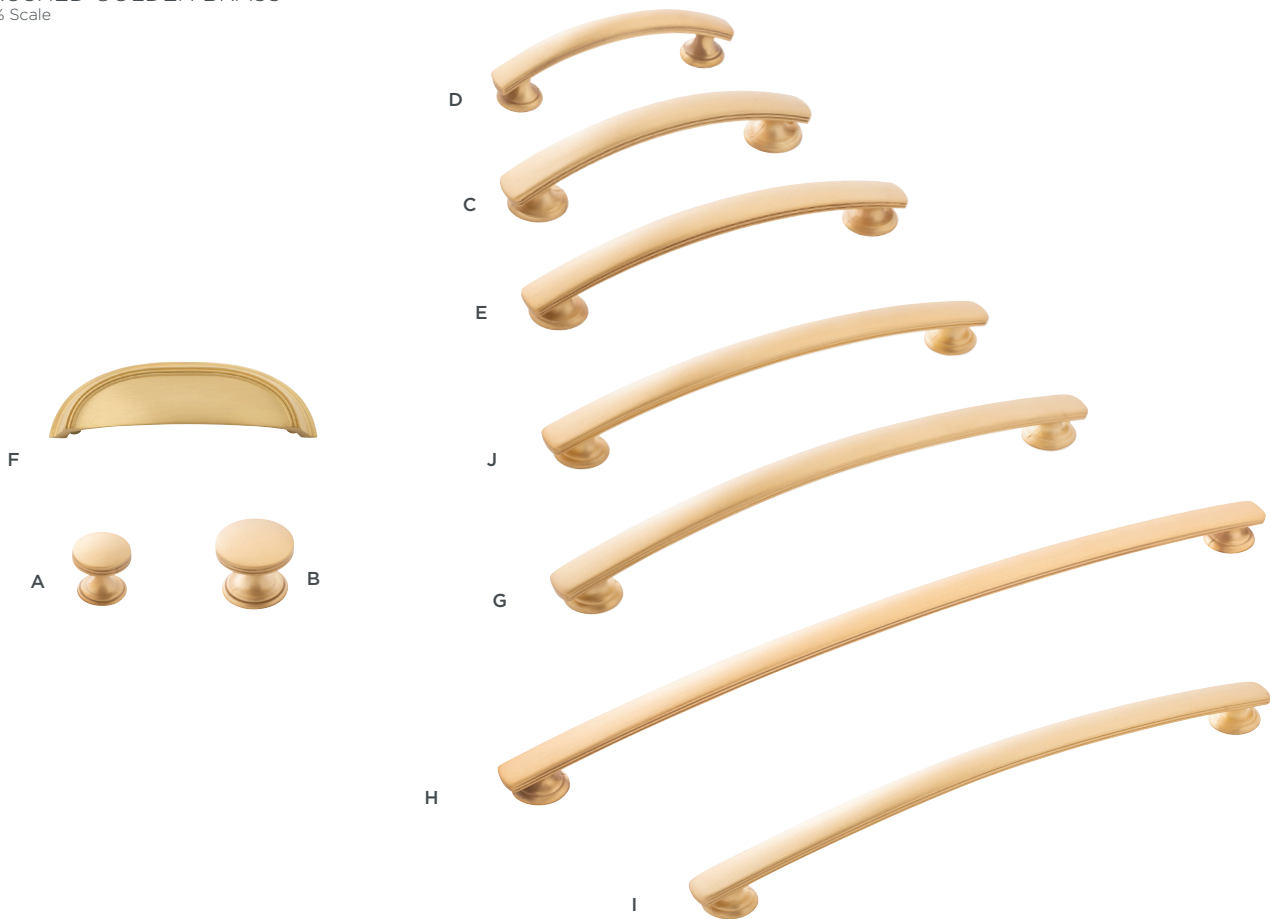

VINTAGE BRONZE  
32% Scale



BLACK NICKEL  
32% Scale

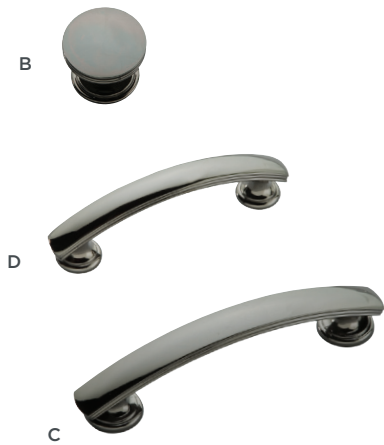

# BRIDGES

	PRODUCT SPECIFICATIONS					PART NUMBER	FINISH CODE			
	C/C	L	W	P	B		Chrome	Satin Nickel	Brushed Golden Brass	Oil-Rubbed Bronze Highlighted
<b>A</b>	128mm	5-13/16"	3/4"	1-1/8"	-	P3233-	CH	SN	BGB	OBH
<b>B</b>	3"	3-5/8"	11/16"	1-1/8"	-	P3231-	CH	SN	BGB	OBH
<b>C</b>	96mm	4-7/16"	11/16"	1-1/8"	-	P3232-	CH	SN	BGB	OBH
<b>D</b>	3", 96mm, 128mm	5-7/8"	1-13/16"	11/16"	-	P3234-	CH	SN	BGB	OBH
<b>E</b>	-	1-3/16"	1-3/16"	1"	1/2" SQ.	P3230-	CH	SN	BGB	OBH
<b>F</b>	-	1-1/4"	1-1/4"	1-1/8"	3/4" SQ.	P3240-	CH	SN	BGB	OBH
<b>G</b>	160mm	7-1/16"	3/4"	1-3/16"	-	P3235-	CH	SN	BGB	OBH
<b>H</b>	12"	12-3/4"	3/4"	1-1/2"	-	P3238-	CH	SN	BGB	OBH
<b>I</b>	224mm	9-9/16"	3/4"	1-5/16"	-	P3237-	CH	SN	BGB	OBH
<b>J</b>	192mm	8-3/8"	3/4"	1-1/4"	-	P3236-	CH	SN	BGB	OBH

Record the "Part Number" including the hyphen followed by the "Finish Code." Example: HH075422-VB

SATIN NICKEL  
32% Scale

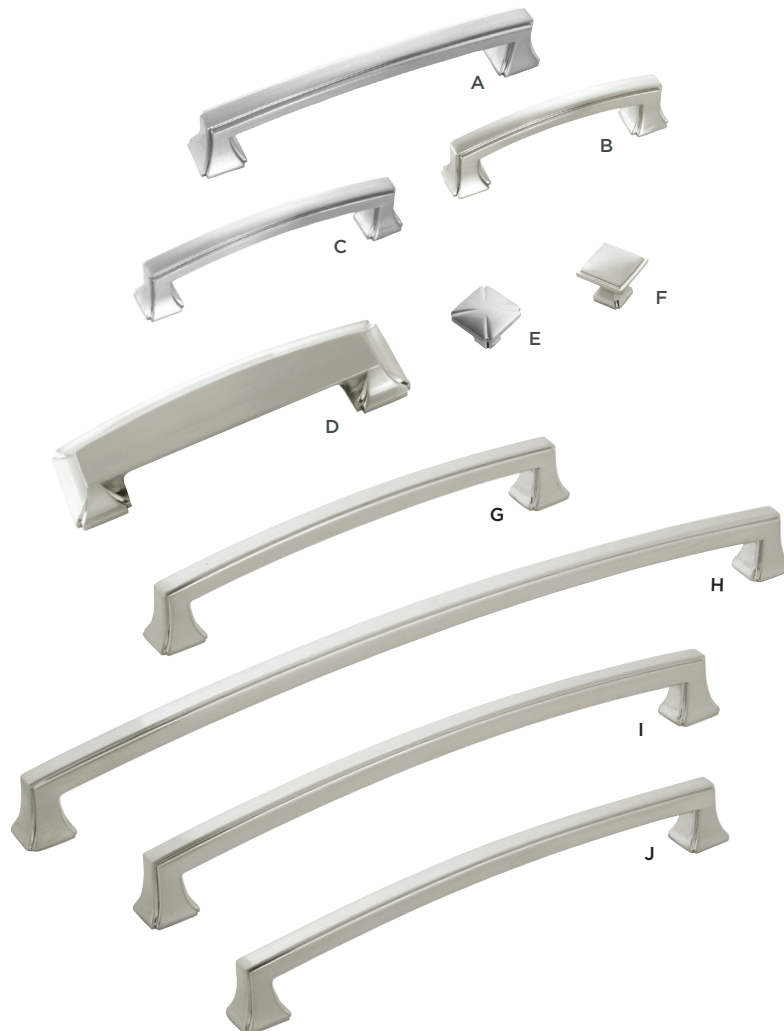

CHROME  
54% Scale



# BRIDGES

	PRODUCT SPECIFICATIONS					PART NUMBER	FINISH CODE			
	C/C	L	W	P	B		Chrome	Satin Nickel	Brushed Golden Brass	Oil-Rubbed Bronze Highlighted
<b>A</b>	128mm	5-13/16"	3/4"	1-1/8"	-	P3233-	CH	SN	BGB	OBH
<b>B</b>	3"	3-5/8"	11/16"	1-1/8"	-	P3231-	CH	SN	BGB	OBH
<b>C</b>	96mm	4-7/16"	11/16"	1-1/8"	-	P3232-	CH	SN	BGB	OBH
<b>D</b>	3", 96mm, 128mm	5-7/8"	1-13/16"	11/16"	-	P3234-	CH	SN	BGB	OBH
<b>E</b>	-	1-3/16"	1-3/16"	1"	1/2" SQ.	P3230-	CH	SN	BGB	OBH
<b>F</b>	-	1-1/4"	1-1/4"	1-1/8"	3/4" SQ.	P3240-	CH	SN	BGB	OBH
<b>G</b>	160mm	7-1/16"	3/4"	1-3/16"	-	P3235-	CH	SN	BGB	OBH
<b>H</b>	12"	12-3/4"	3/4"	1-1/2"	-	P3238-	CH	SN	BGB	OBH
<b>I</b>	224mm	9-9/16"	3/4"	1-5/16"	-	P3237-	CH	SN	BGB	OBH
<b>J</b>	192mm	8-3/8"	3/4"	1-1/4"	-	P3236-	CH	SN	BGB	OBH

Record the "Part Number" including the hyphen followed by the "Finish Code." Example: HH075422-VB

## BRUSHED GOLDEN BRASS 32% Scale

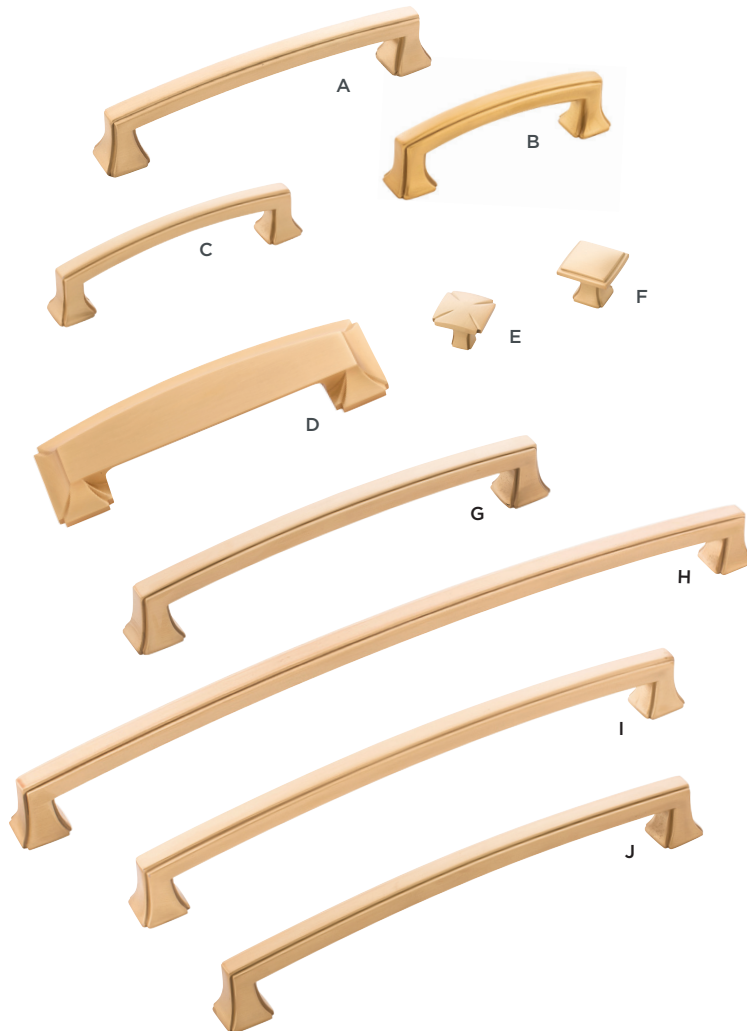



OIL-RUBBED BRONZE HIGHLIGHTED  
32% Scale



# BUNGALOW

PRODUCT SPECIFICATIONS					PART NUMBER	FINISH CODE					
C/C	L	W	P	B		Polished Nickel	Satin Nickel	Windover Antique	Oil-Rubbed Bronze Highlighted	Oil-Rubbed Bronze	
<b>A</b>	-	1-1/4"	11/16"	7/8"	3/4" x 7/16"	P2150-	14	SN	WOA	OBH	10B
<b>B</b>	-	1-3/4"	15/16"	1"	1-1/16" x 9/16"	P2151-	14	SN	WOA	OBH	10B
<b>C</b>	-	2-5/16"	1-1/16"	1"	1-3/8" x 5/8"	P2152-	14	SN	WOA	OBH	10B
<b>D</b>	3" & 96mm	5-5/8"	1-1/16"	1"	-	P2153-	14	SN	WOA	OBH	10B

Record the "Part Number" including the hyphen followed by the "Finish Code." Example: HH075422-VB

## POLISHED NICKEL 54% Scale

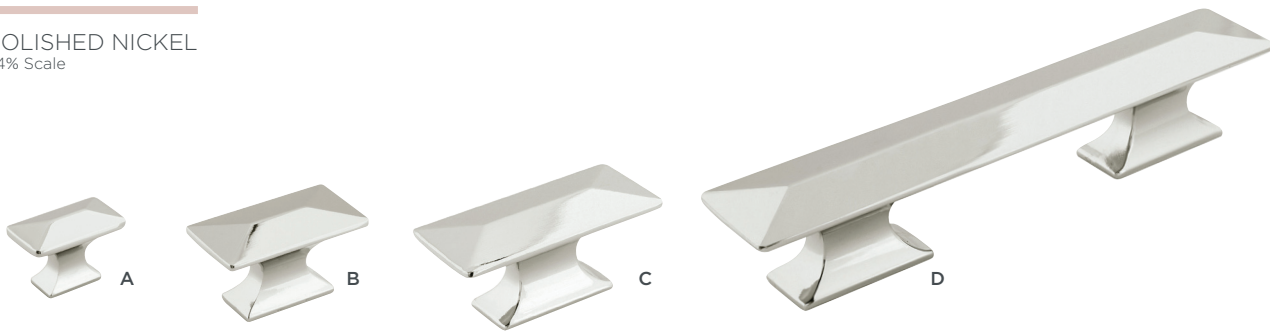

## SATIN NICKEL 54% Scale

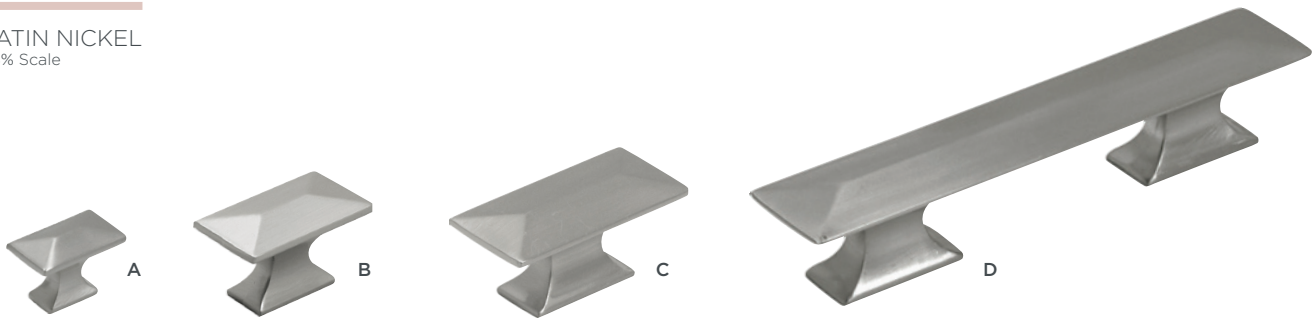

## MATCHING HOOKS AVAILABLE

See page 189 for specs and finish options. Not to scale.

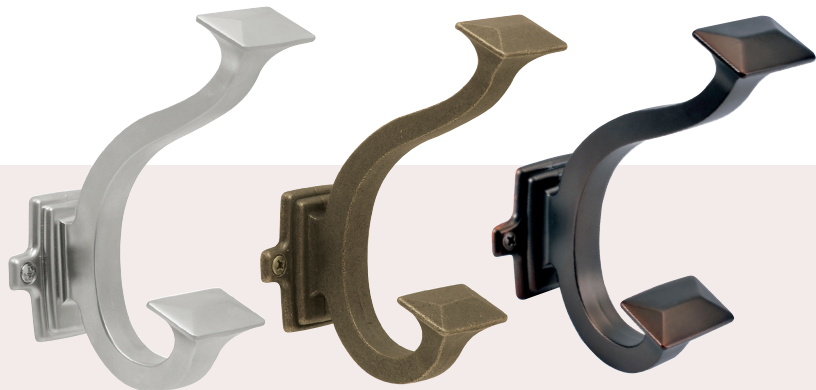



WINDOVER ANTIQUE  
54% Scale

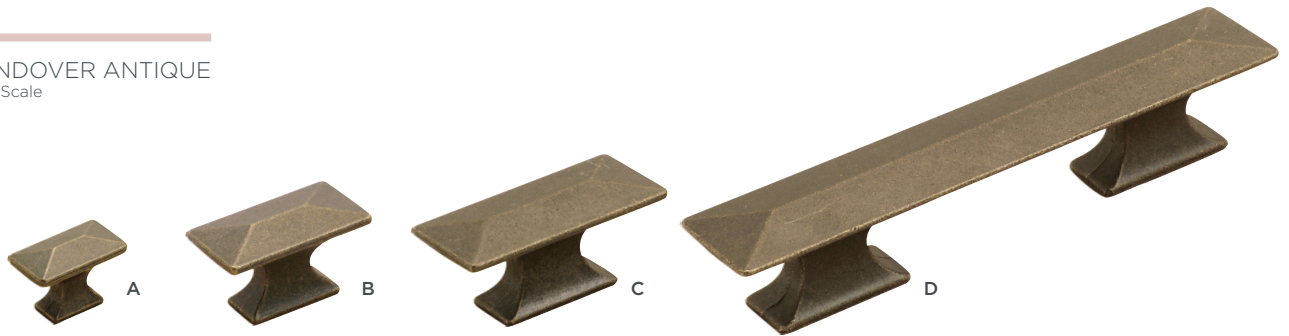

OIL-RUBBED BRONZE HIGHLIGHTED  
54% Scale

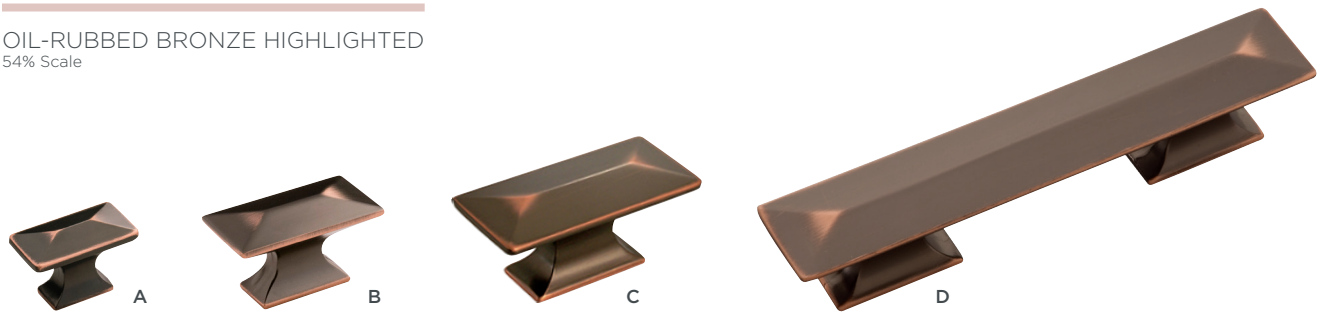

OIL-RUBBED BRONZE  
54% Scale

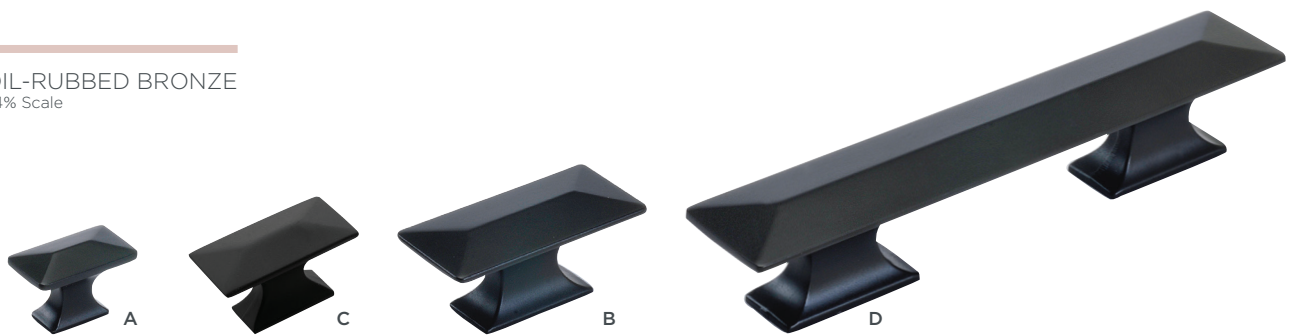

# COTTAGE

PRODUCT SPECIFICATIONS						PART NUMBER	FINISH CODE				
C/C	L	W	P	D	B		Chrome	Satin Nickel	Stainless Steel	Vintage Bronze	Oil-Rubbed Bronze
A	-	-	1-3/16"	1-1/4"	13/16"	P3151-	CH	SN	-	VB	10B
B	-	-	1-1/16"	1-1/4"	5/8"	P771-	CH	SN	SS	VB	10B
C	-	-	7/8"	1-1/8"	5/8"	P770-	CH	SN	SS	VB	10B
D	-	-	1"	1-1/4"	15/16"	P3500-	-	SN	SS	VB	10B
E	-	-	1-1/8"	1-1/2"	1"	P3501-	-	SN	SS	VB	10B
F	3"	3-7/16"	7/16"	1-3/16"	-	P3382-	-	SN	SS	VB	10B
G	96mm	4-1/4"	7/16"	1-1/4"	-	P3381-	-	SN	SS	VB	10B
H	128mm	5-1/2"	1/2"	1-3/16"	-	P3380-	-	SN	SS	VB	10B
I	3"	4-3/4"	1-7/16"	1"	-	P3077-	-	SN	SS	VB	10B
J	8"	8-7/8"	7/8"	2-3/8"	-	K60-	-	15	SS	-	-
K	24"	24-7/8"	7/8"	2-3/8"	-	K63-	-	15	SS	-	-
L	18"	18-7/8"	7/8"	2-3/8"	-	K62-	-	15	SS	-	-
M	12"	12-7/8"	7/8"	2-3/8"	-	K61-	-	15	SS	-	-

Record the "Part Number" including the hyphen followed by the "Finish Code." Example: HH075422-VB

## STAINLESS STEEL

32% Scale



TRANSITIONAL

SATIN NICKEL  
32% Scale



SATIN NICKEL  
54% Scale



CHROME  
54% Scale



# COTTAGE

PRODUCT SPECIFICATIONS							PART NUMBER	FINISH CODE				
C/C	L	W	P	D	B	Chrome		Satin Nickel	Stainless Steel	Vintage Bronze	Oil-Rubbed Bronze	
<b>A</b>	-	-	-	1-3/16"	1-1/4"	13/16"	P3151-	CH	SN	-	VB	10B
<b>B</b>	-	-	-	1-1/16"	1-1/4"	5/8"	P771-	CH	SN	SS	VB	10B
<b>C</b>	-	-	-	7/8"	1-1/8"	5/8"	P770-	CH	SN	SS	VB	10B
<b>D</b>	-	-	-	1"	1-1/4"	15/16"	P3500-	-	SN	SS	VB	10B
<b>E</b>	-	-	-	1-1/8"	1-1/2"	1"	P3501-	-	SN	SS	VB	10B
<b>F</b>	3"	3-7/16"	7/16"	1-3/16"	-	-	P3382-	-	SN	SS	VB	10B
<b>G</b>	96mm	4-1/4"	7/16"	1-1/4"	-	-	P3381-	-	SN	SS	VB	10B
<b>H</b>	128mm	5-1/2"	1/2"	1-3/16"	-	-	P3380-	-	SN	SS	VB	10B
<b>I</b>	3"	4-3/4"	1-7/16"	1"	-	-	P3077-	-	SN	SS	VB	10B
<b>J</b>	8"	8-7/8"	7/8"	2-3/8"	-	-	K60-	-	15	SS	-	-
<b>K</b>	24"	24-7/8"	7/8"	2-3/8"	-	-	K63-	-	15	SS	-	-
<b>L</b>	18"	18-7/8"	7/8"	2-3/8"	-	-	K62-	-	15	SS	-	-
<b>M</b>	12"	12-7/8"	7/8"	2-3/8"	-	-	K61-	-	15	SS	-	-

Record the "Part Number" including the hyphen followed by the "Finish Code." Example: HH075422-VB



## MATCHING HOOKS AVAILABLE

See page 190 for specs and finish options. Not to scale.



VINTAGE BRONZE  
54% Scale



OIL-RUBBED BRONZE  
54% Scale



# FORGE

	PRODUCT SPECIFICATIONS						PART NUMBER	FINISH CODE					
	C/C	L	W	P	D	B		Chrome	Satin Nickel	Brushed Golden Brass	Polished Copper	Vintage Bronze	Black Iron
<b>A</b>	-	-	-	1-1/8"	1-3/8"	3/4"	H076698-	CH	SN	BGB	CP	VB	BI
<b>B</b>	-	1-7/16"	1-1/4"	1-1/8"	-	15/16"x3/4"	H076699-	CH	SN	BGB	CP	VB	BI
<b>C</b>	3"	4-3/4"	1-1/8"	1"	-	-	H076700-	CH	SN	BGB	CP	VB	BI
<b>D</b>	160mm	7-5/8"	1-1/8"	1-1/8"	-	-	H076703-	CH	SN	BGB	CP	VB	BI
<b>E</b>	96mm	5-1/16"	1-1/8"	1"	-	-	H076701-	CH	SN	BGB	CP	VB	BI
<b>F</b>	128mm	6-5/16"	1-1/8"	1"	-	-	H076702-	CH	SN	BGB	CP	VB	BI
<b>G</b>	12"	13-3/8"	1-1/8"	1-1/8"	-	-	H076706-	CH	SN	BGB	CP	VB	BI
<b>H</b>	224mm	10-1/8"	1-1/8"	1-1/8"	-	-	H076705-	CH	SN	BGB	CP	VB	BI
<b>I</b>	192mm	8-7/8"	1-1/8"	1-1/8"	-	-	H076704-	CH	SN	BGB	CP	VB	BI

Record the "Part Number" including the hyphen followed by the "Finish Code." Example: HH075422-VB

## CHROME

54% Scale





SATIN NICKEL  
32% Scale

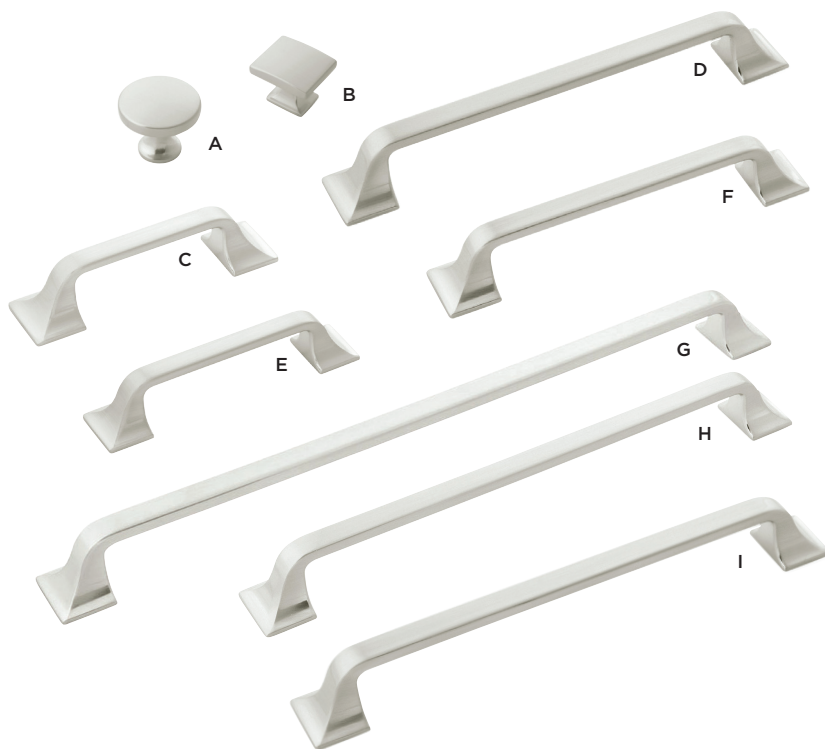

BRUSHED GOLDEN BRASS  
32% Scale

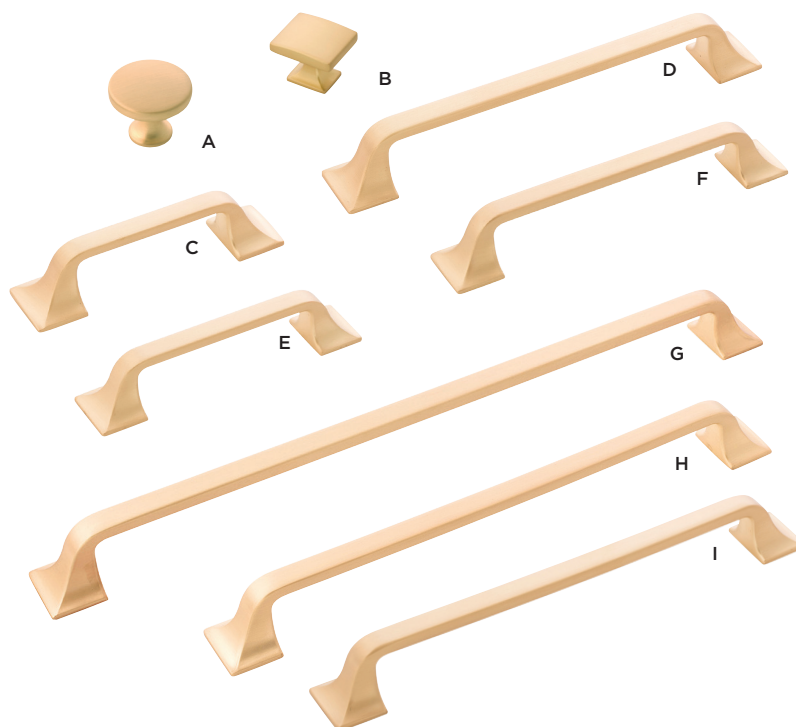

# FORGE

	PRODUCT SPECIFICATIONS						PART NUMBER	FINISH CODE					
	C/C	L	W	P	D	B		Chrome	Satin Nickel	Brushed Golden Brass	Polished Copper	Vintage Bronze	Black Iron
<b>A</b>	-	-	-	1-1/8"	1-3/8"	3/4"	H076698-	CH	SN	BGB	CP	VB	BI
<b>B</b>	-	1-7/16"	1-1/4"	1-1/8"	-	15/16"x3/4"	H076699-	CH	SN	BGB	CP	VB	BI
<b>C</b>	3"	4-3/4"	1-1/8"	1"	-	-	H076700-	CH	SN	BGB	CP	VB	BI
<b>D</b>	160mm	7-5/8"	1-1/8"	1-1/8"	-	-	H076703-	CH	SN	BGB	CP	VB	BI
<b>E</b>	96mm	5-1/16"	1-1/8"	1"	-	-	H076701-	CH	SN	BGB	CP	VB	BI
<b>F</b>	128mm	6-5/16"	1-1/8"	1"	-	-	H076702-	CH	SN	BGB	CP	VB	BI
<b>G</b>	12"	13-3/8"	1-1/8"	1-1/8"	-	-	H076706-	CH	SN	BGB	CP	VB	BI
<b>H</b>	224mm	10-1/8"	1-1/8"	1-1/8"	-	-	H076705-	CH	SN	BGB	CP	VB	BI
<b>I</b>	192mm	8-7/8"	1-1/8"	1-1/8"	-	-	H076704-	CH	SN	BGB	CP	VB	BI

Record the "Part Number" including the hyphen followed by the "Finish Code." Example: HH075422-VB

## POLISHED COPPER 32% Scale

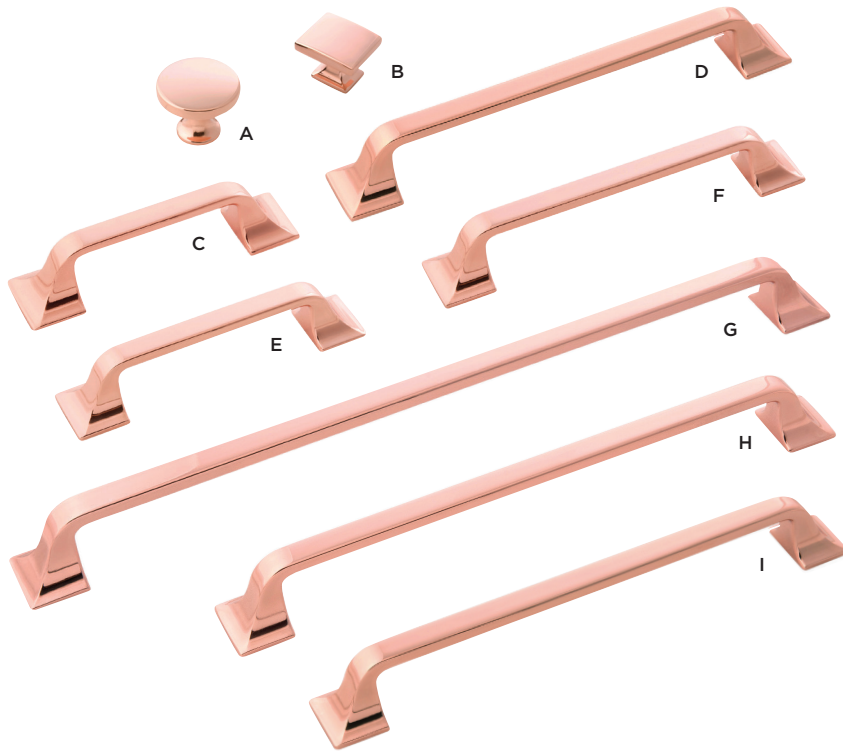

### MATCHING HOOKS AVAILABLE

See page 191 for specs and finish options. Not to scale.



VINTAGE BRONZE  
32% Scale

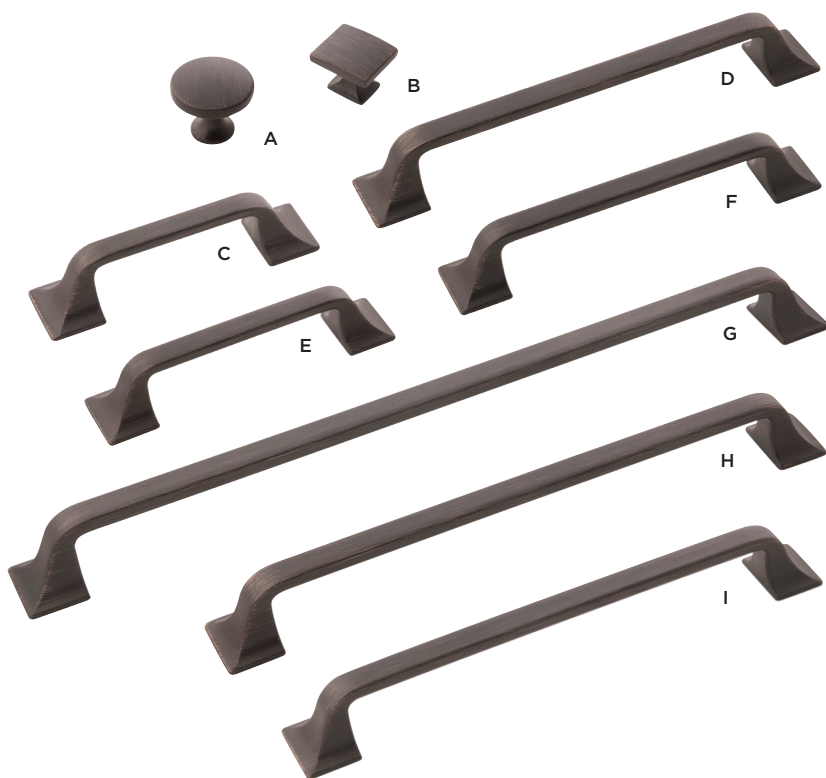

BLACK IRON  
32% Scale

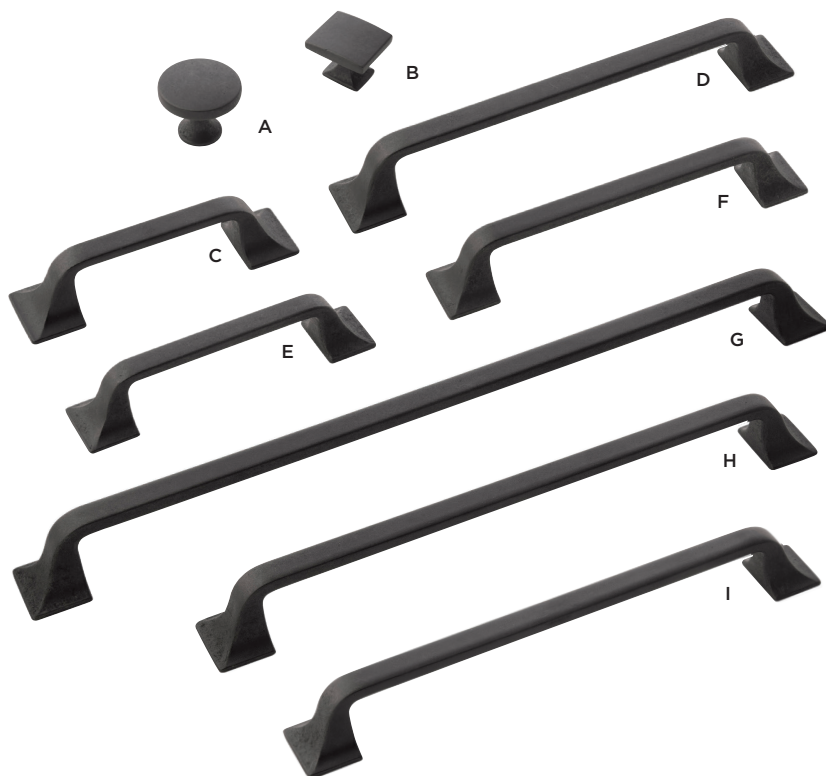

# SAVOY

PRODUCT SPECIFICATIONS							PART NUMBER	FINISH CODE		
C/C	L	W	P	D	B		Chrome	Black Nickel Viced	Oil-Rubbed Bronze Highlighted	
A	-	-	1-1/4"	1-1/4"	9/16"	P2243-	CH	BNV	OBH	
B	128mm	5-7/8"	13/16"	1-1/8"	-	P2242-	CH	BNV	OBH	
C	96mm	4-9/16"	13/16"	1-1/8"	-	P2241-	CH	BNV	OBH	
D	3"	3-13/16"	13/16"	1-1/8"	-	P2240-	CH	BNV	OBH	

Record the "Part Number" including the hyphen followed by the "Finish Code." Example: HH075422-VB

## CHROME

54% Scale



## BLACK NICKEL VIBED

54% Scale



---

OIL-RUBBED BRONZE HIGHLIGHTED  
54% Scale



# SERENDIPITY

PRODUCT SPECIFICATIONS					PART NUMBER	FINISH CODE		
C/C	L	W	P	B		Iced Tea Nickel	Black Iron	
<b>A</b>	-	1-1/2"	1-1/4"	1-3/16"	1/2"	HH74729-	ITN	BI
<b>B</b>	-	2-1/8"	11/16"	1-1/4"	9/16"	HH74730-	ITN	BI
<b>C</b>	3" & 96mm	4-15/16"	5/8"	1-3/16"	-	HH74728-	ITN	BI
<b>D</b>	128mm	6-9/16"	5/8"	1-1/4"	-	HH74731-	ITN	BI
<b>E</b>	160mm	8-1/8"	11/16"	1-1/4"	-	HH74733-	ITN	BI

Record the "Part Number" including the hyphen followed by the "Finish Code." Example: HH075422-VB

## ICED TEA NICKEL 54% Scale

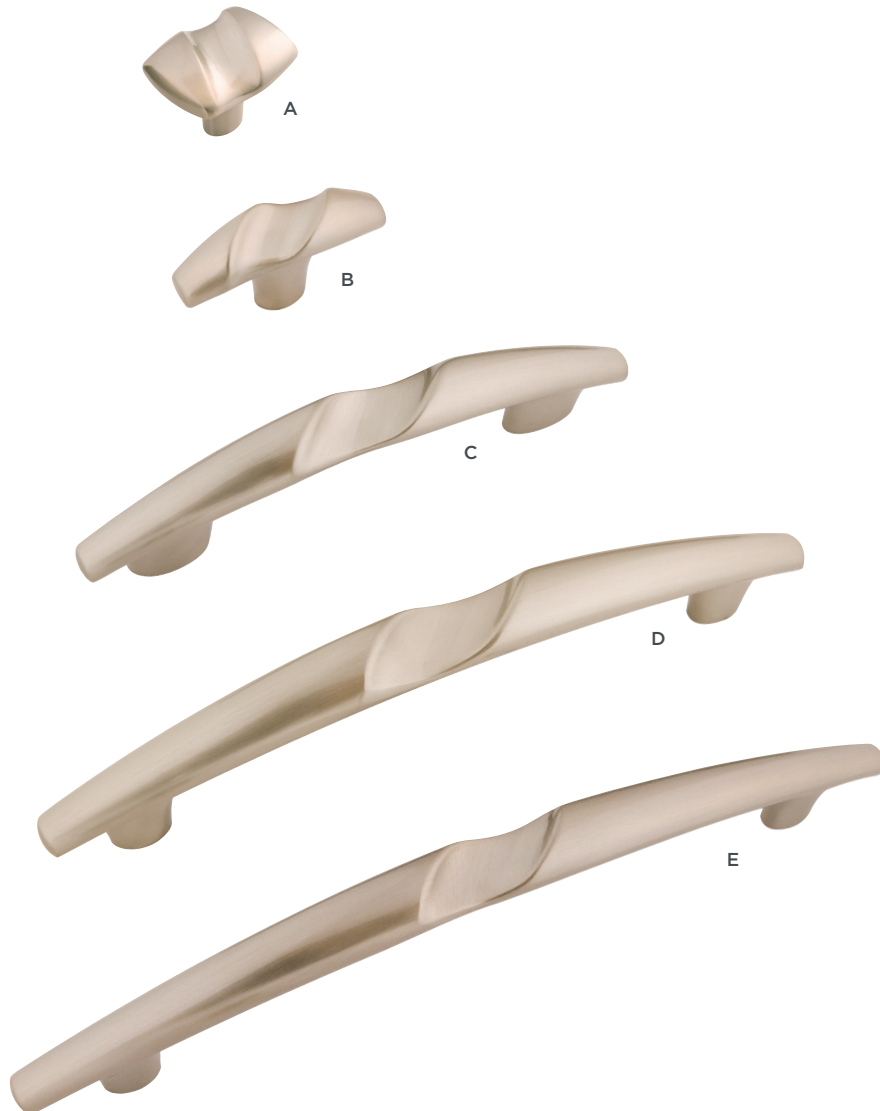

BLACK IRON  
54% Scale



	PRODUCT SPECIFICATIONS						PART NUMBER	FINISH CODE						
	C/C	L	W	P	D	B		Polished Nickel	Satin Nickel	Stainless Steel	Brushed Golden Brass	Polished Copper	Veneti Bronze	Oil-Rubbed Bronze Highlighted
<b>A</b>	3" & 96mm	4-7/8"	2"	1"	-	-	P3013-	14	SN	SS	BGB	CP	VBZ	OBH
<b>B</b>	-	-	-	1"	1" SQ.	3/4" SQ.	P3014-	14	SN	-	-	-	-	OBH
<b>C</b>	-	-	-	1-1/4"	1-1/4" SQ.	1" SQ.	P3015-	14	SN	SS	BGB	CP	VBZ	OBH
<b>D</b>	-	-	-	1"	1-1/4" SQ.	7/8" SQ.	P3028-	14	SN	-	BGB	CP	-	OBH
<b>E</b>	8" AP*	8-5/8"	1-3/8"	1-5/8"	-	-	P3017-	14	SN	-	-	-	-	OBH
<b>F</b>	96mm	4-3/4"	1-1/8"	1-1/8"	-	-	P3011-	14	SN	SS	BGB	CP	VBZ	OBH
<b>G</b>	13" AP*	14-5/8"	1-5/8"	2"	-	-	P3016-	14	SN	-	-	-	-	OBH
<b>H</b>	18" AP*	19-5/8"	1-5/8"	2"	-	-	P2279-	14	SN	SS	-	-	VBZ	OBH
<b>I</b>	12"	13-1/8"	1-1/8"	1-1/2"	-	-	P3027-	14	SN	-	BGB	CP	-	OBH
<b>J</b>	128mm	6-1/8"	1-1/4"	1-3/8"	-	-	P3012-	14	SN	SS	BGB	CP	VBZ	OBH
<b>K</b>	224mm	10"	1-1/8"	1-1/2"	-	-	P3026-	14	SN	-	BGB	CP	-	OBH
<b>L</b>	3"	3-7/8"	1-1/8"	1-1/12"	-	-	P3010-	14	SN	SS	BGB	CP	VBZ	OBH
<b>M</b>	192mm	8-3/4"	1-1/8"	1-1/2"	-	-	P3019-	14	SN	-	BGB	CP	-	OBH
<b>N</b>	160mm	7-1/2"	1-1/8"	1-3/8"	-	-	P3018-	14	SN	-	BGB	CP	-	OBH

Record the "Part Number" including the hyphen followed by the "Finish Code." Example: HH075422-VB  
 AP\* = Appliance Pull

TRANSITIONAL

## POLISHED NICKEL

54% Scale

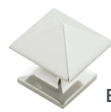



POLISHED NICKEL  
32% Scale



	PRODUCT SPECIFICATIONS						PART NUMBER	FINISH CODE						
	C/C	L	W	P	D	B		Polished Nickel	Satin Nickel	Stainless Steel	Brushed Golden Brass	Polished Copper	Veneti Bronze	Oil-Rubbed Bronze Highlighted
<b>A</b>	3" & 96mm	4-7/8"	2"	1"	-	-	P3013-	14	SN	SS	BGB	CP	VBZ	OBH
<b>B</b>	-	-	-	1"	1" SQ.	3/4" SQ.	P3014-	14	SN	-	-	-	-	OBH
<b>C</b>	-	-	-	1-1/4"	1-1/4" SQ.	1" SQ.	P3015-	14	SN	SS	BGB	CP	VBZ	OBH
<b>D</b>	-	-	-	1"	1-1/4" SQ.	7/8" SQ.	P3028-	14	SN	-	BGB	CP	-	OBH
<b>E</b>	8" AP*	8-5/8"	1-3/8"	1-5/8"	-	-	P3017-	14	SN	-	-	-	-	OBH
<b>F</b>	96mm	4-3/4"	1-1/8"	1-1/8"	-	-	P3011-	14	SN	SS	BGB	CP	VBZ	OBH
<b>G</b>	13" AP*	14-5/8"	1-5/8"	2"	-	-	P3016-	14	SN	-	-	-	-	OBH
<b>H</b>	18" AP*	19-5/8"	1-5/8"	2"	-	-	P2279-	14	SN	SS	-	-	VBZ	OBH
<b>I</b>	12"	13-1/8"	1-1/8"	1-1/2"	-	-	P3027-	14	SN	-	BGB	CP	-	OBH
<b>J</b>	128mm	6-1/8"	1-1/4"	1-3/8"	-	-	P3012-	14	SN	SS	BGB	CP	VBZ	OBH
<b>K</b>	224mm	10"	1-1/8"	1-1/2"	-	-	P3026-	14	SN	-	BGB	CP	-	OBH
<b>L</b>	3"	3-7/8"	1-1/8"	1-1/12"	-	-	P3010-	14	SN	SS	BGB	CP	VBZ	OBH
<b>M</b>	192mm	8-3/4"	1-1/8"	1-1/2"	-	-	P3019-	14	SN	-	BGB	CP	-	OBH
<b>N</b>	160mm	7-1/2"	1-1/8"	1-3/8"	-	-	P3018-	14	SN	-	BGB	CP	-	OBH

Record the "Part Number" including the hyphen followed by the "Finish Code." Example: HH075422-VB  
 AP\* = Appliance Pull

TRANSITIONAL

## STAINLESS STEEL 32% Scale

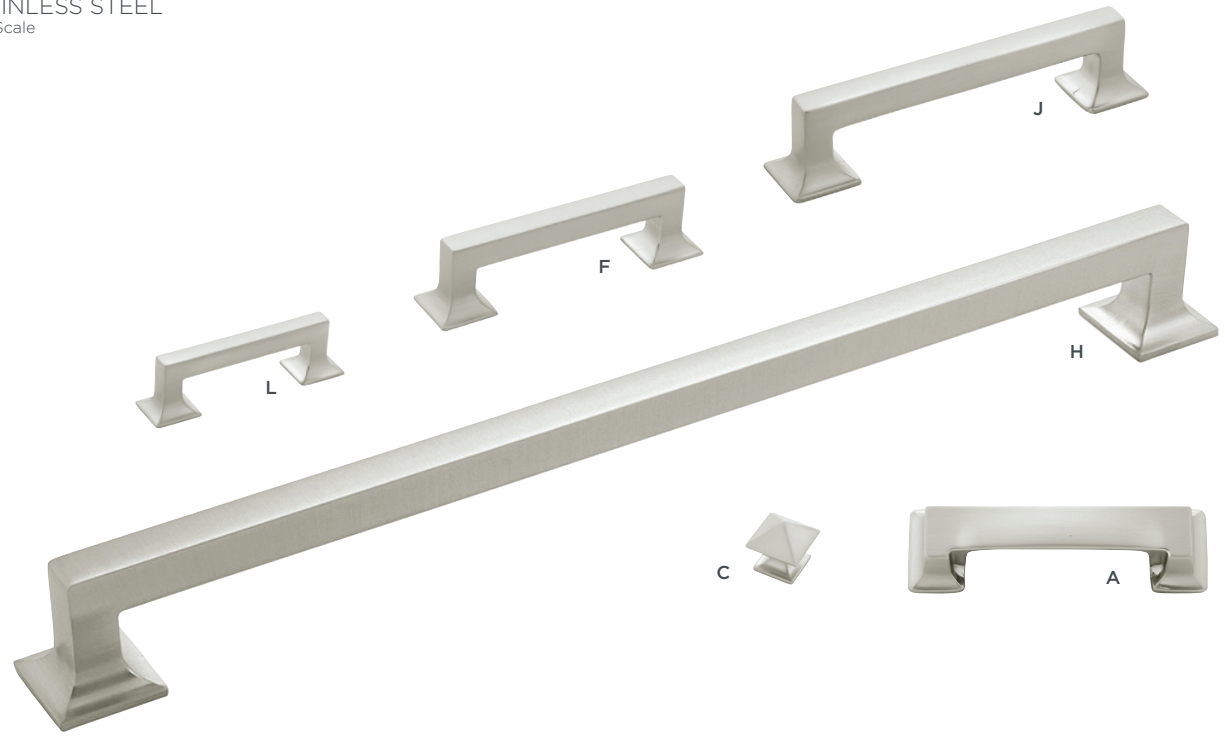

SATIN NICKEL  
32% Scale

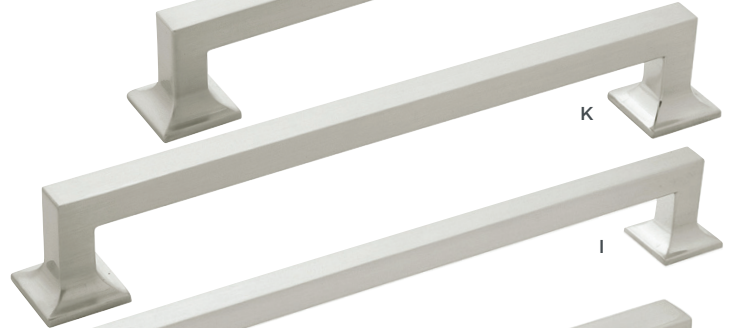
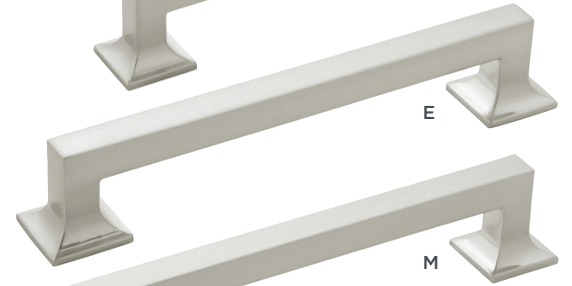

# STUDIO

	PRODUCT SPECIFICATIONS						PART NUMBER	FINISH CODE						
	C/C	L	W	P	D	B		Polished Nickel	Satin Nickel	Stainless Steel	Brushed Golden Brass	Polished Copper	Veneti Bronze	Oil-Rubbed Bronze Highlighted
<b>A</b>	3" & 96mm	4-7/8"	2"	1"	-	-	P3013-	14	SN	SS	BGB	CP	VBZ	OBH
<b>B</b>	-	-	-	1"	1" SQ.	3/4" SQ.	P3014-	14	SN	-	-	-	-	OBH
<b>C</b>	-	-	-	1-1/4"	1-1/4" SQ.	1" SQ.	P3015-	14	SN	SS	BGB	CP	VBZ	OBH
<b>D</b>	-	-	-	1"	1-1/4" SQ.	7/8" SQ.	P3028-	14	SN	-	BGB	CP	-	OBH
<b>E</b>	8" AP*	8-5/8"	1-3/8"	1-5/8"	-	-	P3017-	14	SN	-	-	-	-	OBH
<b>F</b>	96mm	4-3/4"	1-1/8"	1-1/8"	-	-	P3011-	14	SN	SS	BGB	CP	VBZ	OBH
<b>G</b>	13" AP*	14-5/8"	1-5/8"	2"	-	-	P3016-	14	SN	-	-	-	-	OBH
<b>H</b>	18" AP*	19-5/8"	1-5/8"	2"	-	-	P2279-	14	SN	SS	-	-	VBZ	OBH
<b>I</b>	12"	13-1/8"	1-1/8"	1-1/2"	-	-	P3027-	14	SN	-	BGB	CP	-	OBH
<b>J</b>	128mm	6-1/8"	1-1/4"	1-3/8"	-	-	P3012-	14	SN	SS	BGB	CP	VBZ	OBH
<b>K</b>	224mm	10"	1-1/8"	1-1/2"	-	-	P3026-	14	SN	-	BGB	CP	-	OBH
<b>L</b>	3"	3-7/8"	1-1/8"	1-1/12"	-	-	P3010-	14	SN	SS	BGB	CP	VBZ	OBH
<b>M</b>	192mm	8-3/4"	1-1/8"	1-1/2"	-	-	P3019-	14	SN	-	BGB	CP	-	OBH
<b>N</b>	160mm	7-1/2"	1-1/8"	1-3/8"	-	-	P3018-	14	SN	-	BGB	CP	-	OBH

Record the "Part Number" including the hyphen followed by the "Finish Code." Example: HH075422-VB

AP\* = Appliance Pull



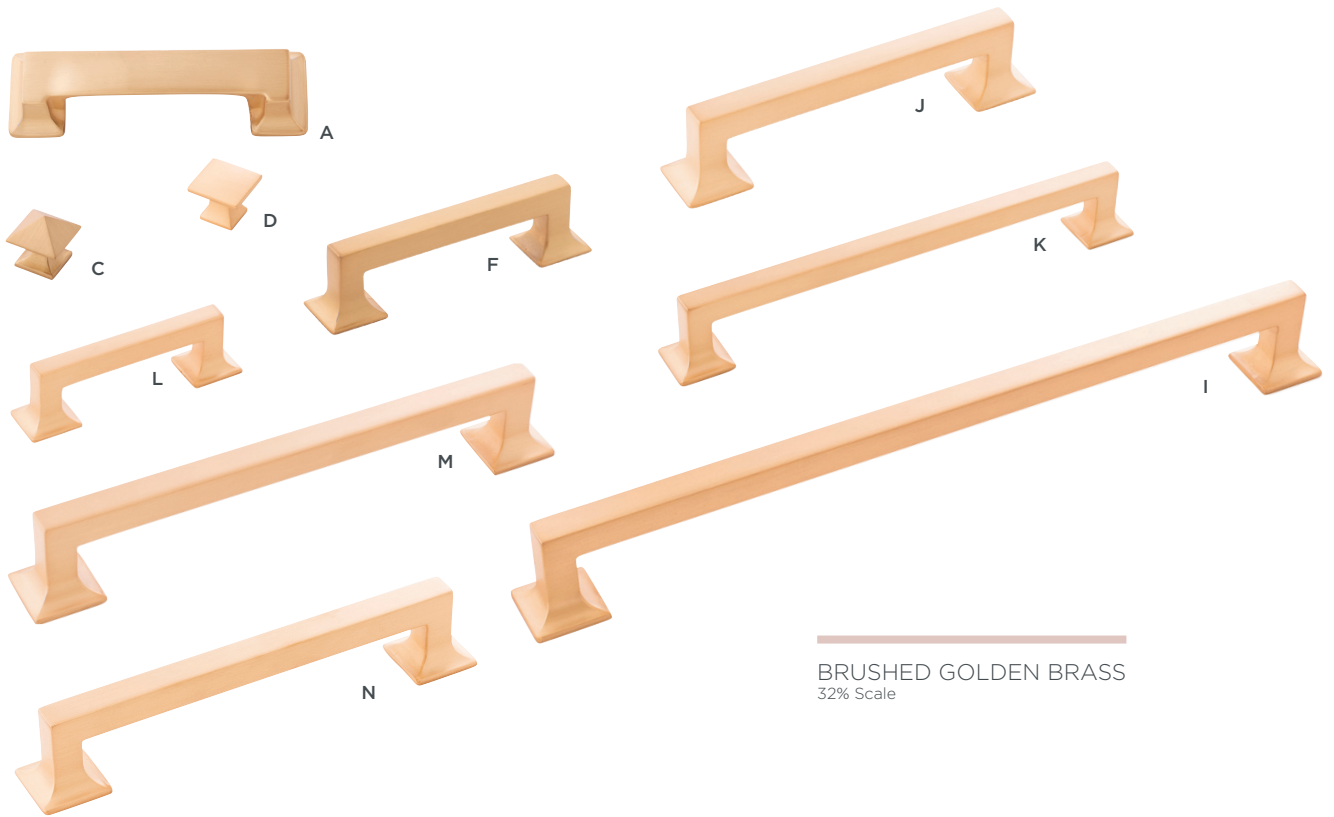

BRUSHED GOLDEN BRASS  
32% Scale

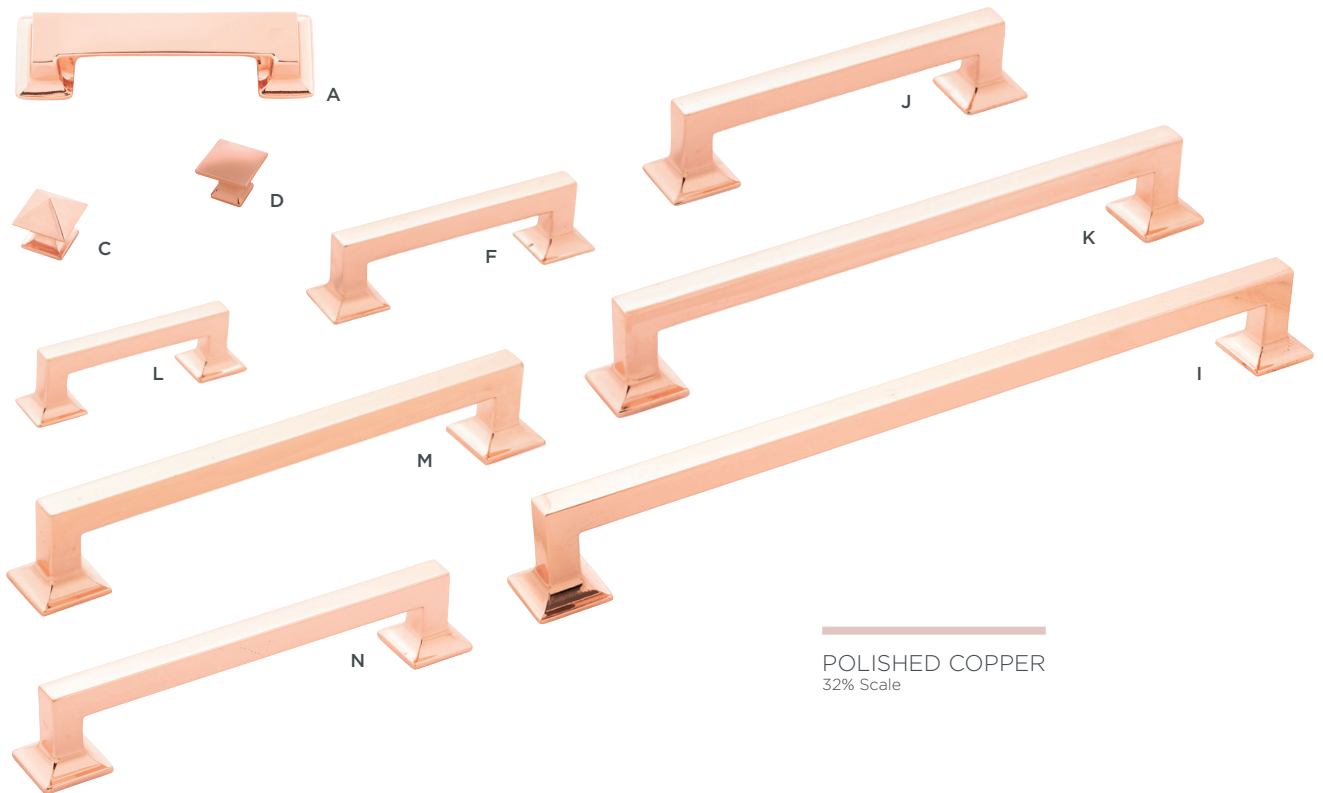

POLISHED COPPER  
32% Scale

	PRODUCT SPECIFICATIONS						PART NUMBER	FINISH CODE						
	C/C	L	W	P	D	B		Polished Nickel	Satin Nickel	Stainless Steel	Brushed Golden Brass	Polished Copper	Veneti Bronze	Oil-Rubbed Bronze Highlighted
<b>A</b>	3" & 96mm	4-7/8"	2"	1"	-	-	P3013-	14	SN	SS	BGB	CP	VBZ	OBH
<b>B</b>	-	-	-	1"	1" SQ.	3/4" SQ.	P3014-	14	SN	-	-	-	-	OBH
<b>C</b>	-	-	-	1-1/4"	1-1/4" SQ.	1" SQ.	P3015-	14	SN	SS	BGB	CP	VBZ	OBH
<b>D</b>	-	-	-	1"	1-1/4" SQ.	7/8" SQ.	P3028-	14	SN	-	BGB	CP	-	OBH
<b>E</b>	8" AP*	8-5/8"	1-3/8"	1-5/8"	-	-	P3017-	14	SN	-	-	-	-	OBH
<b>F</b>	96mm	4-3/4"	1-1/8"	1-1/8"	-	-	P3011-	14	SN	SS	BGB	CP	VBZ	OBH
<b>G</b>	13" AP*	14-5/8"	1-5/8"	2"	-	-	P3016-	14	SN	-	-	-	-	OBH
<b>H</b>	18" AP*	19-5/8"	1-5/8"	2"	-	-	P2279-	14	SN	SS	-	-	VBZ	OBH
<b>I</b>	12"	13-1/8"	1-1/8"	1-1/2"	-	-	P3027-	14	SN	-	BGB	CP	-	OBH
<b>J</b>	128mm	6-1/8"	1-1/4"	1-3/8"	-	-	P3012-	14	SN	SS	BGB	CP	VBZ	OBH
<b>K</b>	224mm	10"	1-1/8"	1-1/2"	-	-	P3026-	14	SN	-	BGB	CP	-	OBH
<b>L</b>	3"	3-7/8"	1-1/8"	1-1/12"	-	-	P3010-	14	SN	SS	BGB	CP	VBZ	OBH
<b>M</b>	192mm	8-3/4"	1-1/8"	1-1/2"	-	-	P3019-	14	SN	-	BGB	CP	-	OBH
<b>N</b>	160mm	7-1/2"	1-1/8"	1-3/8"	-	-	P3018-	14	SN	-	BGB	CP	-	OBH

Record the "Part Number" including the hyphen followed by the "Finish Code." Example: HH075422-VB  
 AP\* = Appliance Pull

TRANSITIONAL

**VENETI BRONZE**  
 32% Scale

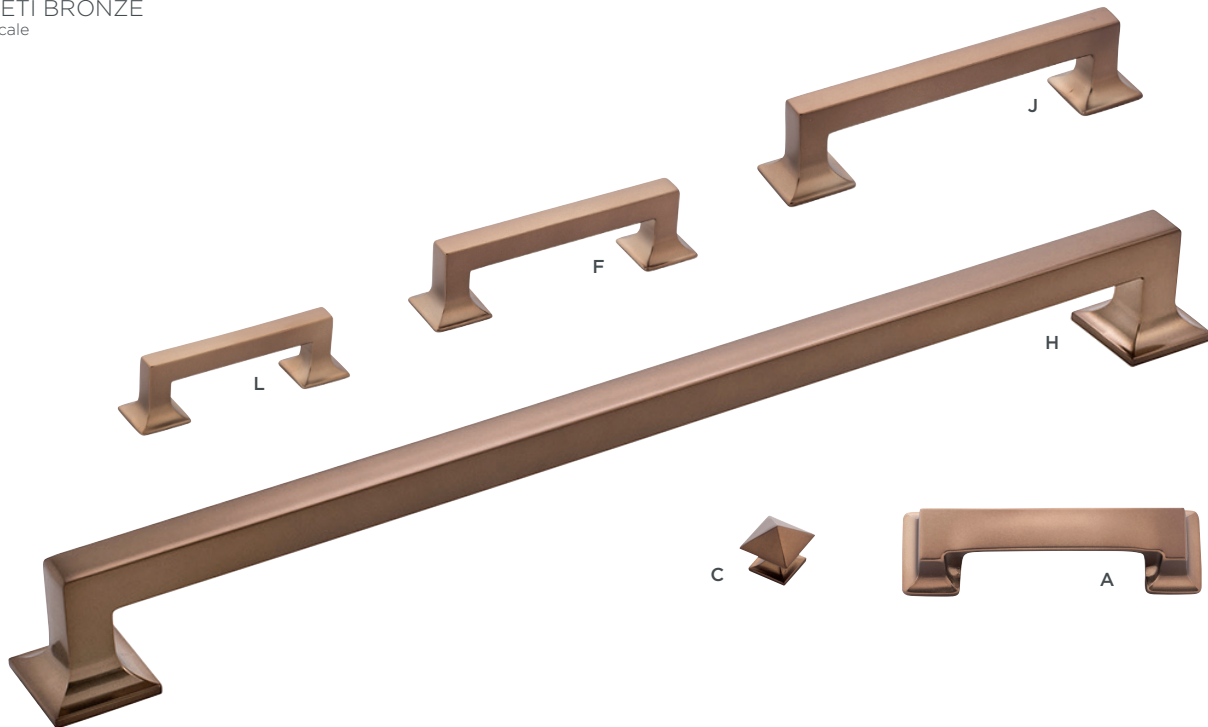

OIL-RUBBED BRONZE HIGHLIGHTED  
32% Scale

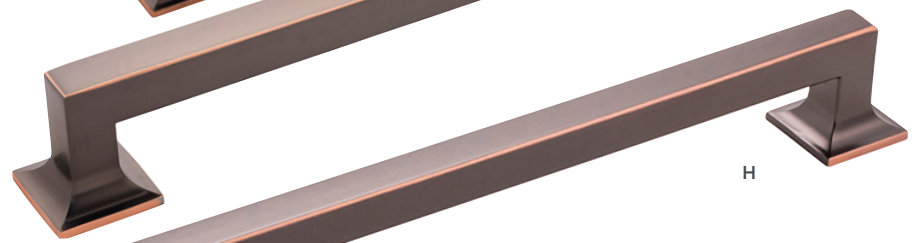
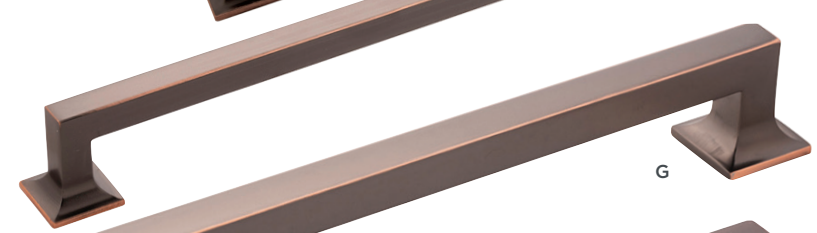
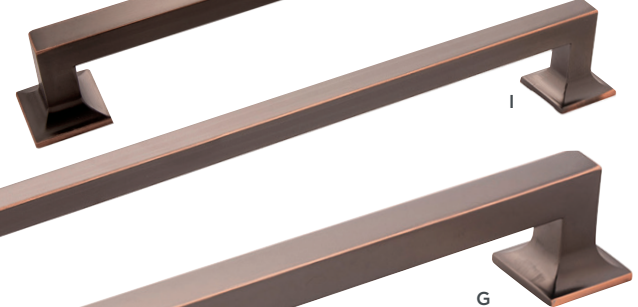
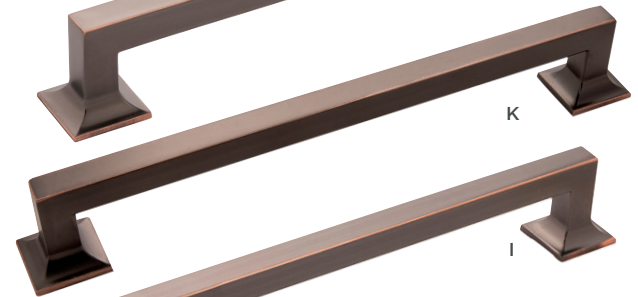
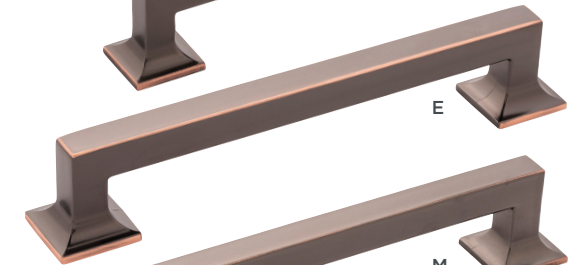
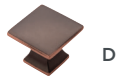
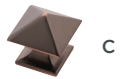
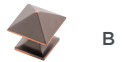

# TWIST

PRODUCT SPECIFICATIONS							PART NUMBER	FINISH CODE				
C/C	L	W	P	D	B	Polished Nickel		Satin Nickel	Elusive Golden Nickel	Polished Copper	Black Iron	
<b>A</b>	-	-	-	1-1/16"	SQ:1-1/4"	9/16" SQ.	H076014-	14	SN	EGN	CP	BI
<b>B</b>	3"	3-5/8"	5/8"	1-1/8"	-	-	H076015-	14	SN	EGN	CP	BI
<b>C</b>	128mm	5-11/16"	5/8"	1-1/8"	-	-	H076017-	14	SN	EGN	CP	BI
<b>D</b>	160mm	6-15/16"	5/8"	1-1/8"	-	-	H076018-	14	SN	EGN	CP	BI
<b>E</b>	12"	12-11/16"	5/8"	1-5/16"	-	-	H076021-	14	SN	EGN	CP	BI
<b>F</b>	224mm	9-9/16"	5/8"	1-1/4"	-	-	H076020-	14	SN	EGN	CP	BI
<b>G</b>	192mm	8-1/4"	5/8"	1-3/16"	-	-	H076019-	14	SN	EGN	CP	BI
<b>H</b>	96mm	4-7/16"	5/8"	1-1/8"	-	-	H076016-	14	SN	EGN	CP	BI

Record the "Part Number" including the hyphen followed by the "Finish Code." Example: HH075422-VB

## POLISHED NICKEL 54% Scale





SATIN NICKEL  
32% Scale

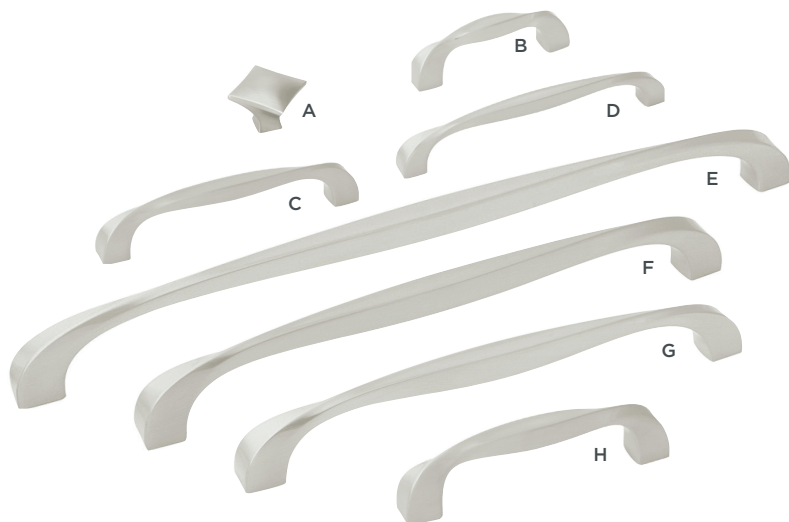

ELUSIVE GOLDEN NICKEL  
32% Scale

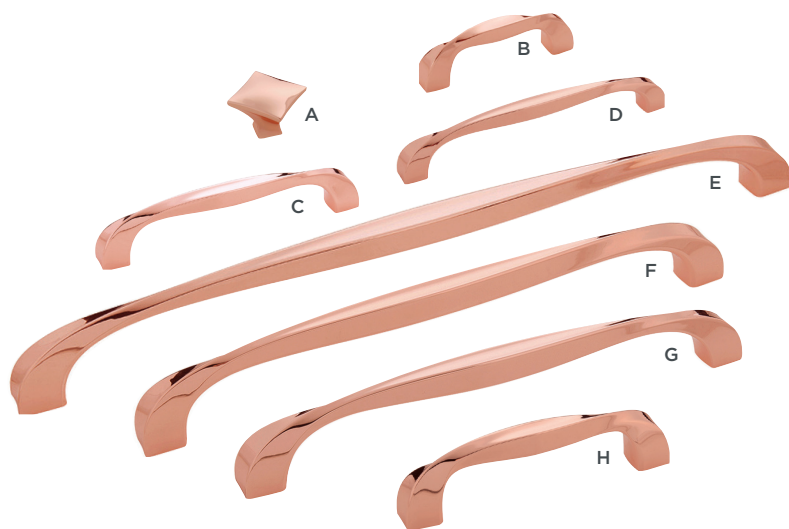
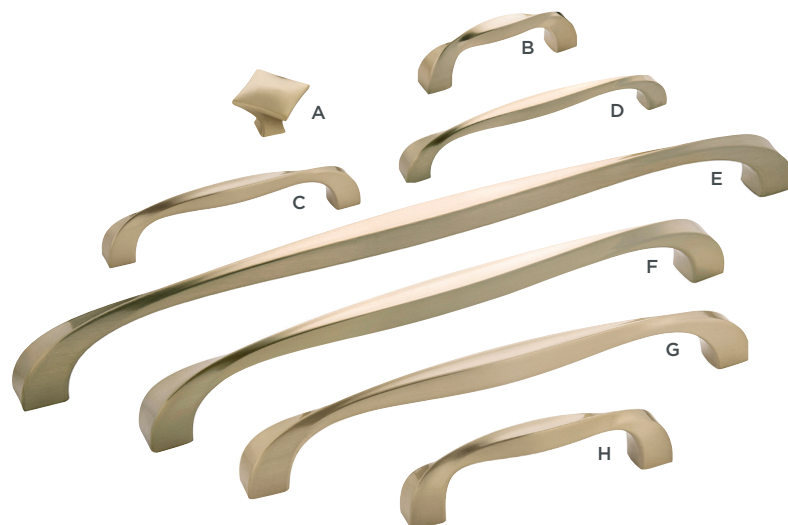

POLISHED COPPER  
32% Scale

# TWIST

PRODUCT SPECIFICATIONS						PART NUMBER	FINISH CODE					
C/C	L	W	P	D	B		Polished Nickel	Satin Nickel	Elusive Golden Nickel	Polished Copper	Black Iron	
<b>A</b>	-	-	-	1-1/16"	SQ:1-1/4"	9/16" SQ.	H076014-	14	SN	EGN	CP	BI
<b>B</b>	3"	3-5/8"	5/8"	1-1/8"	-	-	H076015-	14	SN	EGN	CP	BI
<b>C</b>	128mm	5-11/16"	5/8"	1-1/8"	-	-	H076017-	14	SN	EGN	CP	BI
<b>D</b>	160mm	6-15/16"	5/8"	1-1/8"	-	-	H076018-	14	SN	EGN	CP	BI
<b>E</b>	12"	12-11/16"	5/8"	1-5/16"	-	-	H076021-	14	SN	EGN	CP	BI
<b>F</b>	224mm	9-9/16"	5/8"	1-1/4"	-	-	H076020-	14	SN	EGN	CP	BI
<b>G</b>	192mm	8-1/4"	5/8"	1-3/16"	-	-	H076019-	14	SN	EGN	CP	BI
<b>H</b>	96mm	4-7/16"	5/8"	1-1/8"	-	-	H076016-	14	SN	EGN	CP	BI

Record the "Part Number" including the hyphen followed by the "Finish Code." Example: HH075422-VB

## BLACK IRON

54% Scale



PRODUCT SPECIFICATIONS							PART NUMBER	FINISH CODE				
C/C	L	W	P	D	B		Chrome	Satin Nickel	Stainless Steel	Black Nickel Vined	Polished Brass	
<b>A</b>	-	1-1/4"	13/16"	1-5/16"	-	9/16"	P3054-	CH	15	SS	BNV	PB
<b>B</b>	-	-	-	1"	1-1/4"	1-1/16"	P3053-	CH	15	SS	BNV	PB
<b>C</b>	128mm	5-7/16"	9/16"	1-1/4"	-	-	P3052-	CH	15	SS	BNV	PB
<b>D</b>	3"	3-3/8"	1/2"	1-1/4"	-	-	P3050-	CH	15	SS	BNV	PB
<b>E</b>	96mm	4-1/8"	1/2"	1-1/4"	-	-	P3051-	CH	15	SS	BNV	PB
<b>F</b>	3"	3-7/16"	1-11/16"	1"	-	-	P3055-	CH	15	SS	BNV	PB
<b>G</b>	8" AP*	8-7/8"	1-3/8"	2-1/2"	-	-	K48-	-	-	SS	BNV	-
<b>H</b>	24" AP*	24-7/8"	1-5/16"	2-7/16"	-	-	K51-	-	-	SS	BNV	-
<b>I</b>	18" AP*	18-7/8"	1-3/8"	2-1/2"	-	-	K50-	-	-	SS	BNV	-
<b>J</b>	12" AP*	12-7/8"	1-3/8"	2-1/2"	-	-	K49-	-	-	SS	BNV	-

Record the "Part Number" including the hyphen followed by the "Finish Code." Example: HH075422-VB  
 AP\* = Appliance Pull

## CHROME

54% Scale



# WILLIAMSBURG

PRODUCT SPECIFICATIONS							PART NUMBER	FINISH CODE				
C/C	L	W	P	D	B		Chrome	Satin Nickel	Stainless Steel	Black Nickel Vined	Polished Brass	
<b>A</b>	-	1-1/4"	13/16"	1-5/16"	-	9/16"	P3054-	CH	15	SS	BNV	PB
<b>B</b>	-	-	-	1"	1-1/4"	1-1/16"	P3053-	CH	15	SS	BNV	PB
<b>C</b>	128mm	5-7/16"	9/16"	1-1/4"	-	-	P3052-	CH	15	SS	BNV	PB
<b>D</b>	3"	3-3/8"	1/2"	1-1/4"	-	-	P3050-	CH	15	SS	BNV	PB
<b>E</b>	96mm	4-1/8"	1/2"	1-1/4"	-	-	P3051-	CH	15	SS	BNV	PB
<b>F</b>	3"	3-7/16"	1-11/16"	1"	-	-	P3055-	CH	15	SS	BNV	PB
<b>G</b>	8" AP*	8-7/8"	1-3/8"	2-1/2"	-	-	K48-	-	-	SS	BNV	-
<b>H</b>	24" AP*	24-7/8"	1-5/16"	2-7/16"	-	-	K51-	-	-	SS	BNV	-
<b>I</b>	18" AP*	18-7/8"	1-3/8"	2-1/2"	-	-	K50-	-	-	SS	BNV	-
<b>J</b>	12" AP*	12-7/8"	1-3/8"	2-1/2"	-	-	K49-	-	-	SS	BNV	-

Record the "Part Number" including the hyphen followed by the "Finish Code." Example: HH075422-VB  
 AP\* = Appliance Pull

## SATIN NICKEL 54% Scale



TRANSITIONAL

STAINLESS STEEL  
54% Scale



STAINLESS STEEL  
32% Scale

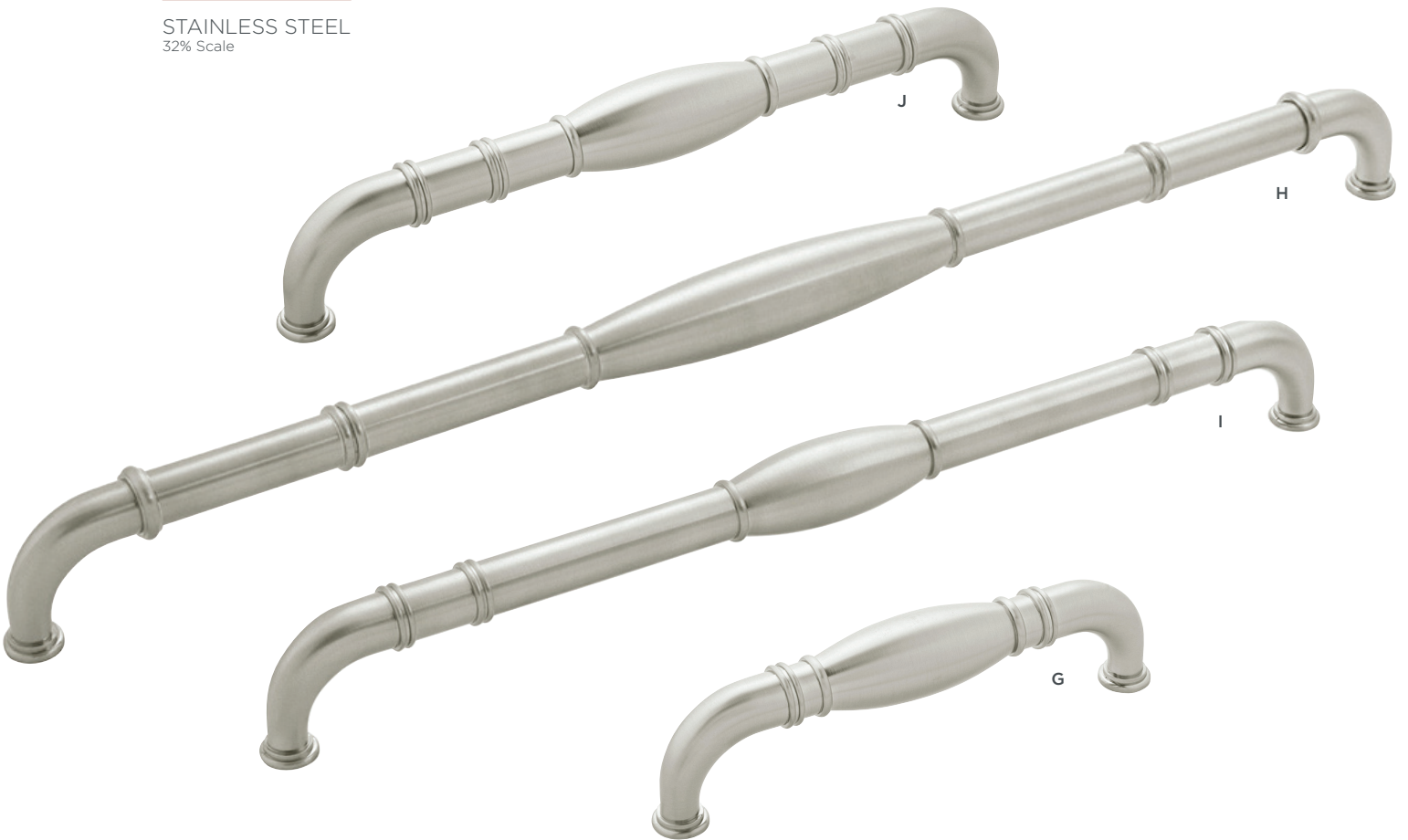

# WILLIAMSBURG

BLACK NICKEL VIBED  
32% Scale

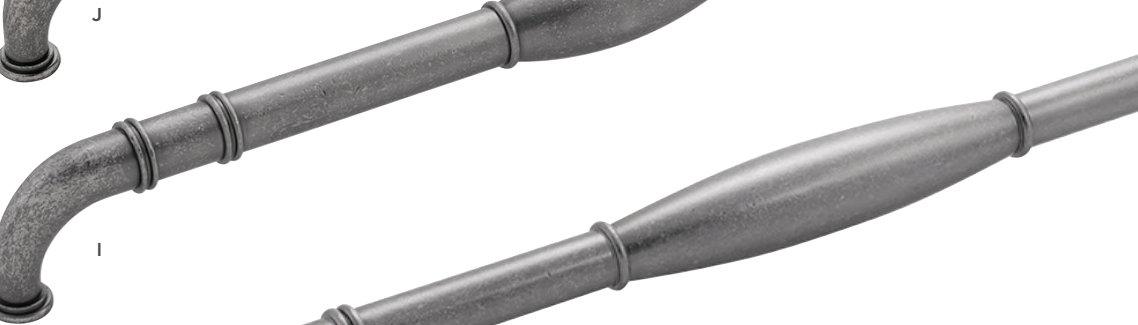

TRANSITIONAL

PRODUCT SPECIFICATIONS							PART NUMBER	FINISH CODE				
C/C	L	W	P	D	B		Chrome	Satin Nickel	Stainless Steel	Black Nickel Vibed	Polished Brass	
<b>A</b>	-	1-1/4"	13/16"	1-5/16"	-	9/16"	P3054-	CH	15	SS	BNV	PB
<b>B</b>	-	-	-	1"	1-1/4"	1-1/16"	P3053-	CH	15	SS	BNV	PB
<b>C</b>	128mm	5-7/16"	9/16"	1-1/4"	-	-	P3052-	CH	15	SS	BNV	PB
<b>D</b>	3"	3-3/8"	1/2"	1-1/4"	-	-	P3050-	CH	15	SS	BNV	PB
<b>E</b>	96mm	4-1/8"	1/2"	1-1/4"	-	-	P3051-	CH	15	SS	BNV	PB
<b>F</b>	3"	3-7/16"	1-11/16"	1"	-	-	P3055-	CH	15	SS	BNV	PB
<b>G</b>	8" AP*	8-7/8"	1-3/8"	2-1/2"	-	-	K48-	-	-	SS	BNV	-
<b>H</b>	24" AP*	24-7/8"	1-5/16"	2-7/16"	-	-	K51-	-	-	SS	BNV	-
<b>I</b>	18" AP*	18-7/8"	1-3/8"	2-1/2"	-	-	K50-	-	-	SS	BNV	-
<b>J</b>	12" AP*	12-7/8"	1-3/8"	2-1/2"	-	-	K49-	-	-	SS	BNV	-

Record the "Part Number" including the hyphen followed by the "Finish Code." Example: HH075422-VB  
 AP\* = Appliance Pull

## POLISHED BRASS

54% Scale



# WILLIAMSBURG

PRODUCT SPECIFICATIONS							PART NUMBER	FINISH CODE				
C/C	L	W	P	D	B	Polished Brass		Dark Antique Copper	Vintage Bronze	Oil-Rubbed Bronze Highlighted	Oil-Rubbed Bronze	
<b>A</b>	-	1-1/4"	13/16"	1-5/16"	-	9/16"	P3054-	PB	DAC	VB	OBH	10B
<b>B</b>	-	-	-	1"	1-1/4"	1-1/16"	P3053-	PB	DAC	VB	OBH	10B
<b>C</b>	128mm	5-7/16"	9/16"	1-1/4"	-	-	P3052-	PB	DAC	VB	OBH	10B
<b>D</b>	3"	3-3/8"	1/2"	1-1/4"	-	-	P3050-	PB	DAC	VB	OBH	10B
<b>E</b>	96mm	4-1/8"	1/2"	1-1/4"	-	-	P3051-	PB	DAC	VB	OBH	10B
<b>F</b>	3"	3-7/16"	1-11/16"	1"	-	-	P3055-	PB	DAC	VB	OBH	10B
<b>G</b>	8" AP*	8-7/8"	1-3/8"	2-1/2"	-	-	K48-	-	-	-	OBH	-
<b>H</b>	24" AP*	24-7/8"	1-5/16"	2-7/16"	-	-	K51-	-	-	-	OBH	-
<b>I</b>	18" AP*	18-7/8"	1-3/8"	2-1/2"	-	-	K50-	-	-	-	OBH	-
<b>J</b>	12" AP*	12-7/8"	1-3/8"	2-1/2"	-	-	K49-	-	-	-	OBH	-

Record the "Part Number" including the hyphen followed by the "Finish Code." Example: HH075422-VB  
 AP\* = Appliance Pull

TRANSITIONAL

## DARK ANTIQUE COPPER 54% Scale





OIL-RUBBED BRONZE HIGHLIGHTED  
32% Scale



# WILLIAMSBURG

PRODUCT SPECIFICATIONS							PART NUMBER	FINISH CODE				
C/C	L	W	P	D	B		Polished Brass	Dark Antique Copper	Vintage Bronze	Oil-Rubbed Bronze Highlighted	Oil-Rubbed Bronze	
<b>A</b>	-	1-1/4"	13/16"	1-5/16"	-	9/16"	P3054-	PB	DAC	VB	OBH	10B
<b>B</b>	-	-	-	1"	1-1/4"	1-1/16"	P3053-	PB	DAC	VB	OBH	10B
<b>C</b>	128mm	5-7/16"	9/16"	1-1/4"	-	-	P3052-	PB	DAC	VB	OBH	10B
<b>D</b>	3"	3-3/8"	1/2"	1-1/4"	-	-	P3050-	PB	DAC	VB	OBH	10B
<b>E</b>	96mm	4-1/8"	1/2"	1-1/4"	-	-	P3051-	PB	DAC	VB	OBH	10B
<b>F</b>	3"	3-7/16"	1-11/16"	1"	-	-	P3055-	PB	DAC	VB	OBH	10B
<b>G</b>	8" AP*	8-7/8"	1-3/8"	2-1/2"	-	-	K48-	-	-	-	OBH	-
<b>H</b>	24" AP*	24-7/8"	1-5/16"	2-7/16"	-	-	K51-	-	-	-	OBH	-
<b>I</b>	18" AP*	18-7/8"	1-3/8"	2-1/2"	-	-	K50-	-	-	-	OBH	-
<b>J</b>	12" AP*	12-7/8"	1-3/8"	2-1/2"	-	-	K49-	-	-	-	OBH	-

Record the "Part Number" including the hyphen followed by the "Finish Code." Example: HH075422-VB  
 AP\* = Appliance Pull

## VINTAGE BRONZE 54% Scale



OIL-RUBBED BRONZE  
54% Scale

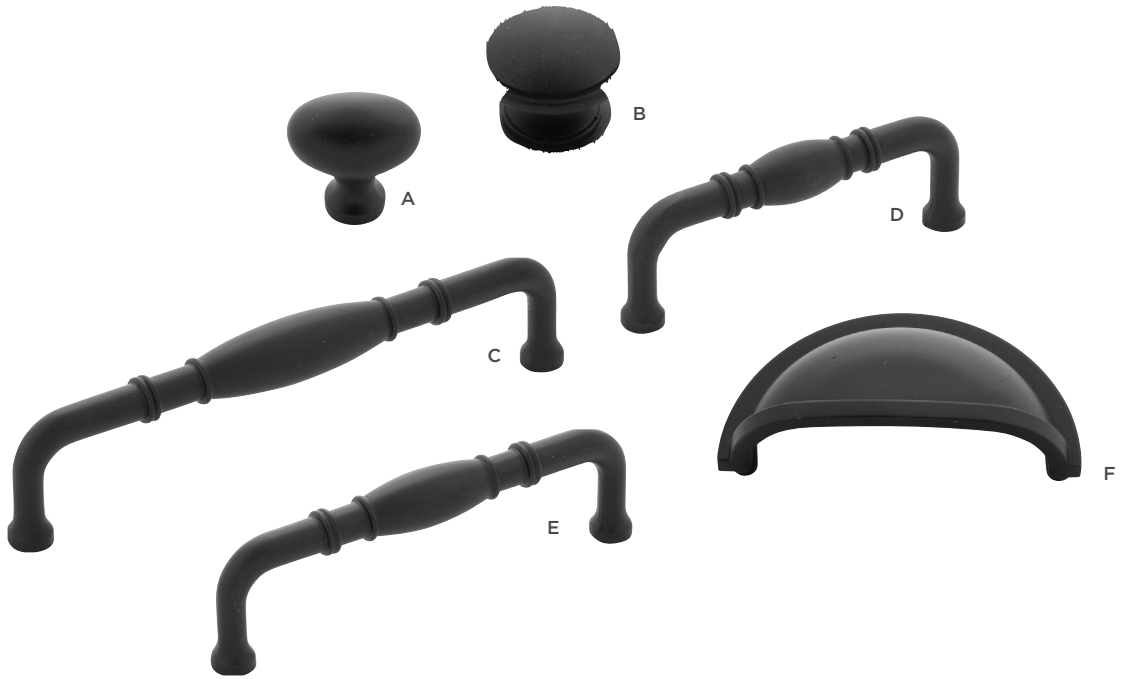

# WILLOW

	PRODUCT SPECIFICATIONS						PART NUMBER	FINISH CODE			
	C/C	L	W	P	D	B		Polished Nickel	Satin Nickel	Flat Ultra Brass	Oil-Rubbed Bronze
<b>A</b>	-	2-1/8"	5/8"	-	-	9/16"	H076653-	14	SN	FUB	10B
<b>B</b>				15/16"	1-3/8"	-	H076652-	14	SN	FUB	10B
<b>C</b>	3"	5"	7/8"	1-1/8"	-	-	H076647-	14	SN	FUB	10B
<b>D</b>	96mm	6-1/2"	15/16"	1-1/8"	-	-	H076648-	14	SN	FUB	10B
<b>E</b>	128mm	7-5/8"	15/16"	1-1/16"	-	-	H076649-	14	SN	FUB	10B
<b>F</b>	160mm	8-15/16"	15/16"	1-1/8"	-	-	H076650-	14	SN	FUB	10B
<b>G</b>	192mm	10-9/16"	15/16"	1-1/8"	-	-	H076651-	14	SN	FUB	10B

Record the "Part Number" including the hyphen followed by the "Finish Code." Example: HH075422-VB

POLISHED NICKEL  
54% Scale



SATIN NICKEL  
32% Scale

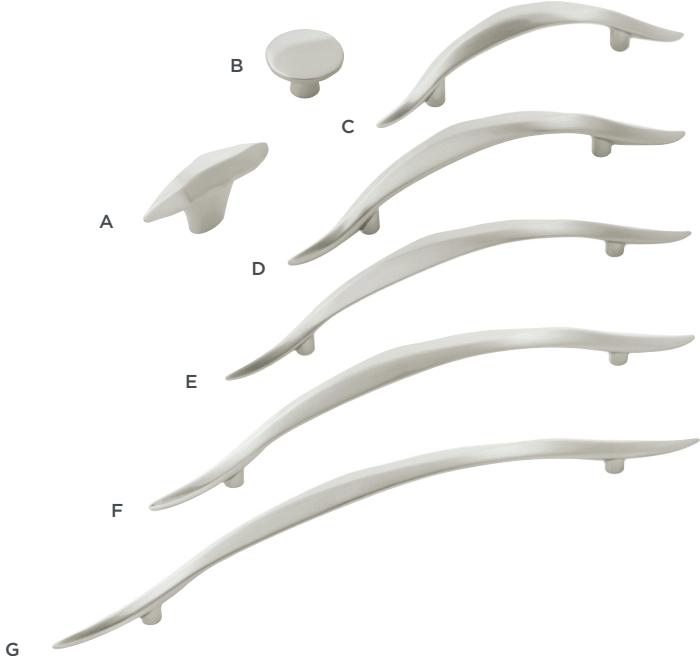

FLAT ULTRA BRASS  
54% Scale

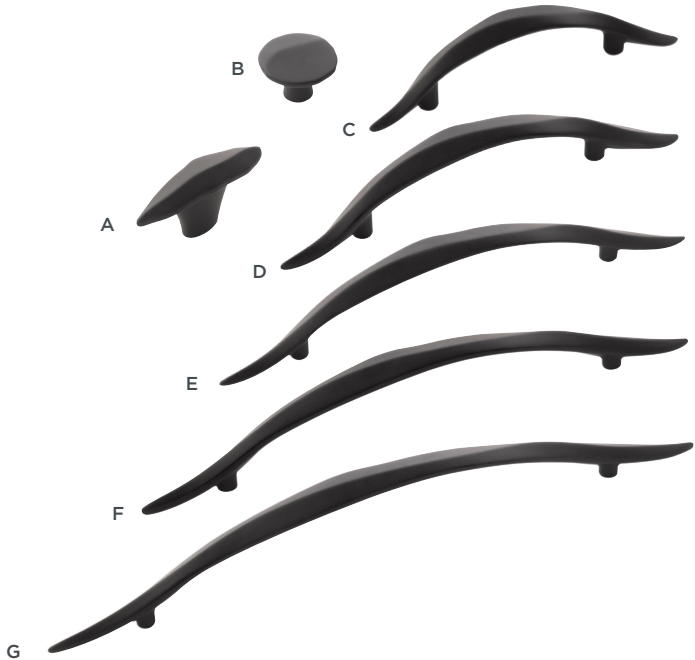
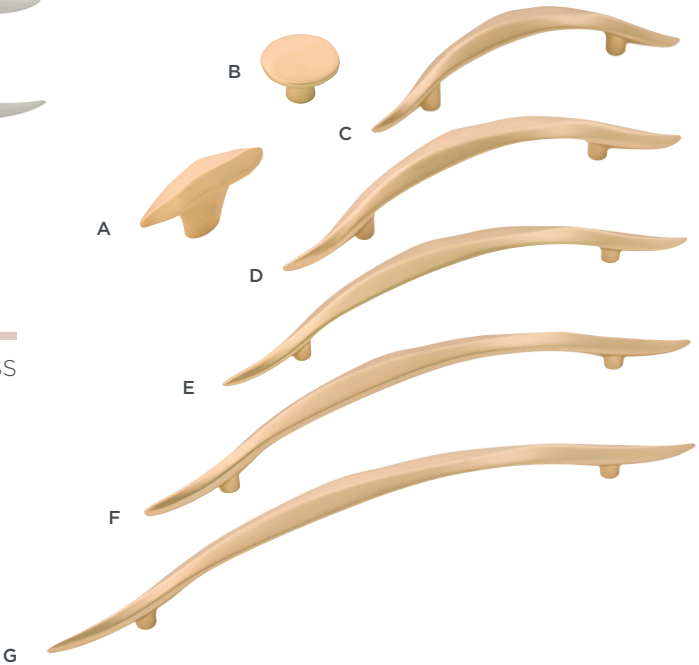

OIL-RUBBED BRONZE  
54% Scale

# ZEPHYR

	PRODUCT SPECIFICATIONS						PART NUMBER	FINISH CODE		
	C/C	L	W	P	D	B		Satin Nickel	Stainless Steel	Oil-Rubbed Bronze Highlighted
<b>A</b>	-	-	-	1-1/8"	1"	13/16"	P2286-	SN	SS	OBH
<b>B</b>	96mm	4-9/16"	13/16"	1-1/8"	-	-	P2281-	SN	SS	OBH
<b>C</b>	3"	3-13/16"	13/16"	1-1/8"	-	-	P2280-	SN	SS	OBH
<b>D</b>	128mm	5-7/8"	13/16"	1-1/8"	-	-	P2282-	SN	SS	OBH
<b>E</b>	-	-	-	1-1/4"	1-1/4"	1"	P2283-	SN	SS	OBH
<b>F</b>	18" AP*	19-3/8"	1-1/2"	2"	-	-	P3008-	SN	SS	OBH
<b>G</b>	13" AP*	14-1/2"	1-1/2"	1-7/8"	-	-	P2289-	SN	SS	OBH
<b>H</b>	8" AP*	9-1/8"	1-1/8"	1-1/2"	-	-	P2288-	SN	SS	OBH

Record the "Part Number" including the hyphen followed by the "Finish Code." Example: HH075422-VB  
 AP\* = Appliance Pull

## SATIN NICKEL

32% Scale



TRANSITIONAL

STAINLESS STEEL  
32% Scale



OIL-RUBBED BRONZE HIGHLIGHTED  
32% Scale



---

# TRANSITIONAL SELECTIONS

A blend of traditional and contemporary styles: classic shapes are softened but not stark; old and new are combined for a fresh new look.



PRODUCT SPECIFICATIONS						PART NUMBER	FINISH CODE								
C/C	L	W	P	D	B		Chrome	Satin Nickel	Polished Brass	Lustre Brass	Veneti Bronze	Vintage Bronze	Oil-Rubbed Bronze Highlighted	White	
<b>A</b>	-	-	-	1"	1-1/8"	1/2"	P14255-	26	SN	3	LB	VBZ	VB	OBH	W
<b>B</b>	-	-	-	15/16"	1-3/16"	5/8"	P14402-	26	SN	3	LB	VBZ	VB	-	W
<b>C</b>	-	-	-	1"	1-1/8"	11/16"	P14004-	26	SN	3	LB	VBZ	-	-	-
<b>D</b>	-	-	-	1-1/16"	1-3/8"	5/8"	P14848-	26	SN	3	LB	VBZ	VB	-	W
<b>E</b>	3"	5"	11/16"	1"	-	-	P14444-	26	SN	3	LB	VBZ	-	OBH	W
<b>F</b>	3"	4-1/2"	9/16"	3/4"	-	-	P14461-	26	SN	-	LB	VBZ	-	-	-
<b>G</b>	3"	3-3/8"	3/4"	7/8"	-	-	P14441-	26	SN	3	LB	-	-	-	-
<b>H</b>	3"	4"	1/2"	7/8"	-	-	P14170-	26	SN	3	LB	VBZ	-	-	W
<b>I</b>	3"	5"	1/2"	1"	-	-	P14174-	26	SN	3	-	VBZ	-	-	W
<b>J</b>	3"	3-1/4"	3/8"	1"	-	-	P14451-	26	SN	3	-	-	-	-	W
<b>K</b>	-	-	-	1"	1-1/8"	3/4"	P14630-	-	-	-	-	-	-	-	W
<b>L</b>	-	-	-	1-1/4"	1-1/4"	5/8"	P14021-	-	-	-	-	-	-	-	W

Record the "Part Number" including the hyphen followed by the "Finish Code." Example: HH075422-VB

## CHROME

54% Scale



# CONQUEST

PRODUCT SPECIFICATIONS							PART NUMBER	FINISH CODE								
C/C	L	W	P	D	B		Chrome	Satin Nickel	Polished Brass	Lustre Brass	Veneti Bronze	Vintage Bronze	Oil-Rubbed Bronze Highlighted	White		
A	-	-	1"	1-1/8"	1/2"	P14255-	26	SN	3	LB	VBZ	VB	OBH	W		
B	-	-	15/16"	1-3/16"	5/8"	P14402-	26	SN	3	LB	VBZ	VB	-	W		
C	-	-	1"	1-1/8"	11/16"	P14004-	26	SN	3	LB	VBZ	-	-	-		
D	-	-	1-1/16"	1-3/8"	5/8"	P14848-	26	SN	3	LB	VBZ	VB	-	W		
E	3"	5"	11/16"	1"	-	P14444-	26	SN	3	LB	VBZ	-	OBH	W		
F	3"	4-1/2"	9/16"	3/4"	-	P14461-	26	SN	-	LB	VBZ	-	-	-		
G	3"	3-3/8"	3/4"	7/8"	-	P14441-	26	SN	3	LB	-	-	-	-		
H	3"	4"	1/2"	7/8"	-	P14170-	26	SN	3	LB	VBZ	-	-	W		
I	3"	5"	1/2"	1"	-	P14174-	26	SN	3	-	VBZ	-	-	W		
J	3"	3-1/4"	3/8"	1"	-	P14451-	26	SN	3	-	-	-	-	W		
K	-	-	1"	1-1/8"	3/4"	P14630-	-	-	-	-	-	-	-	W		
L	-	-	1-1/4"	1-1/4"	5/8"	P14021-	-	-	-	-	-	-	-	W		

Record the "Part Number" including the hyphen followed by the "Finish Code." Example: HH075422-VB

## SATIN NICKEL 54% Scale

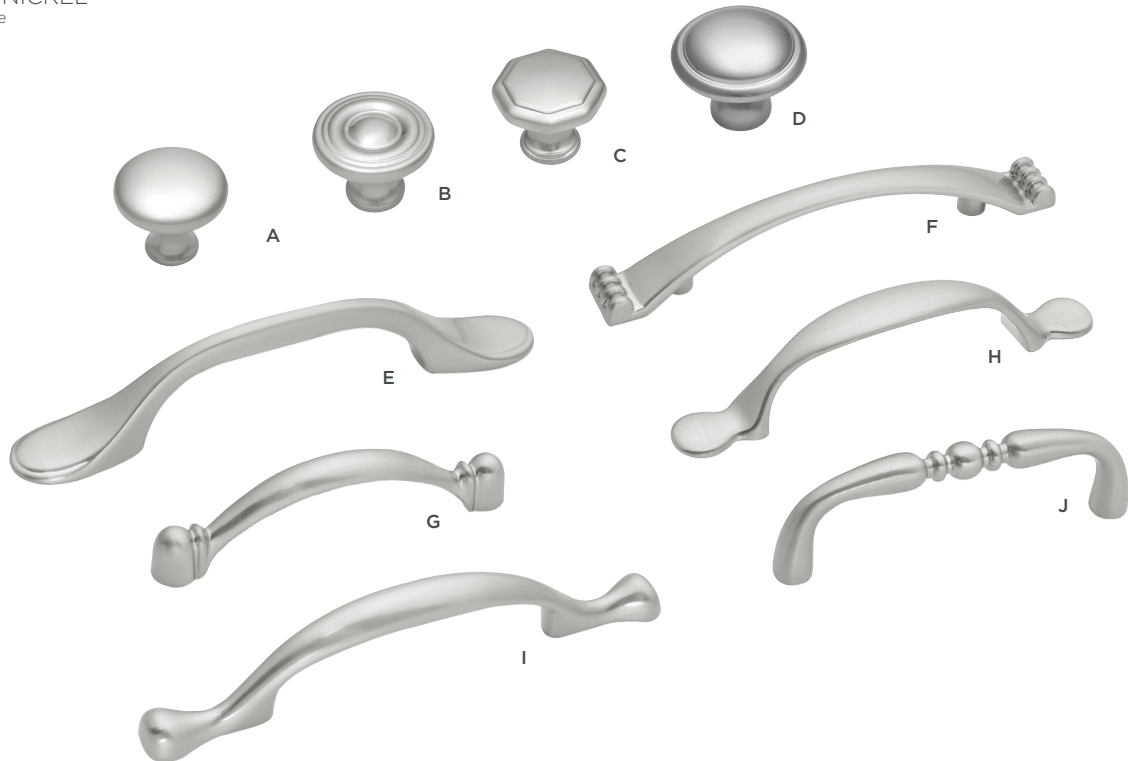

POLISHED BRASS  
54% Scale

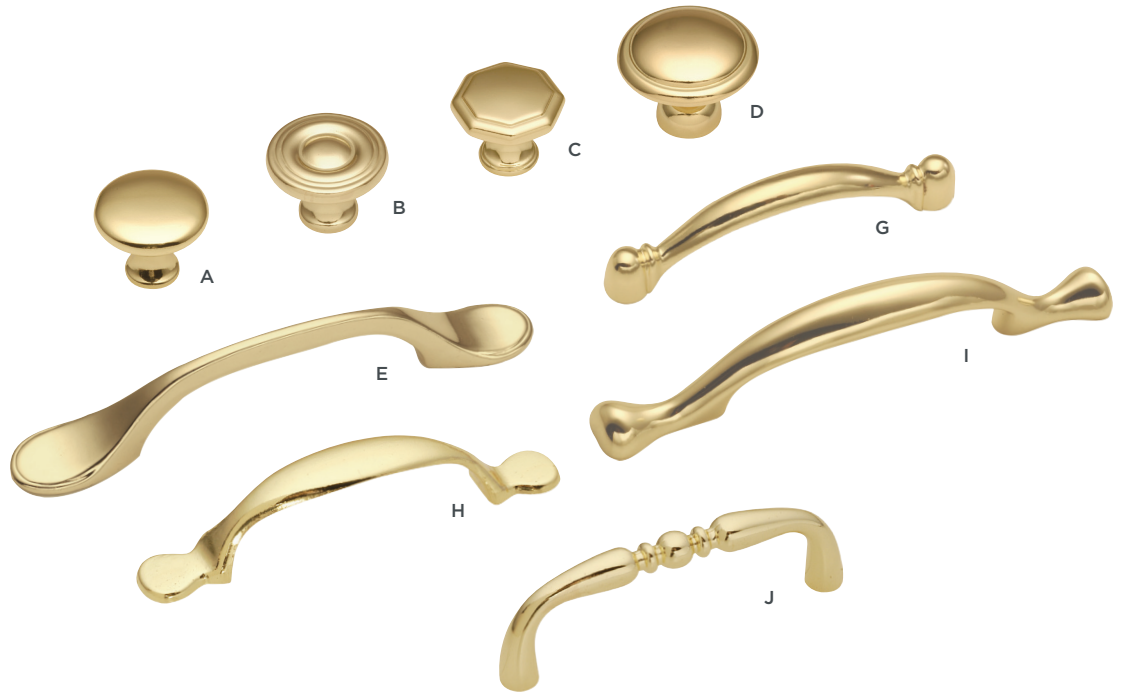

LUSTRE BRASS  
54% Scale

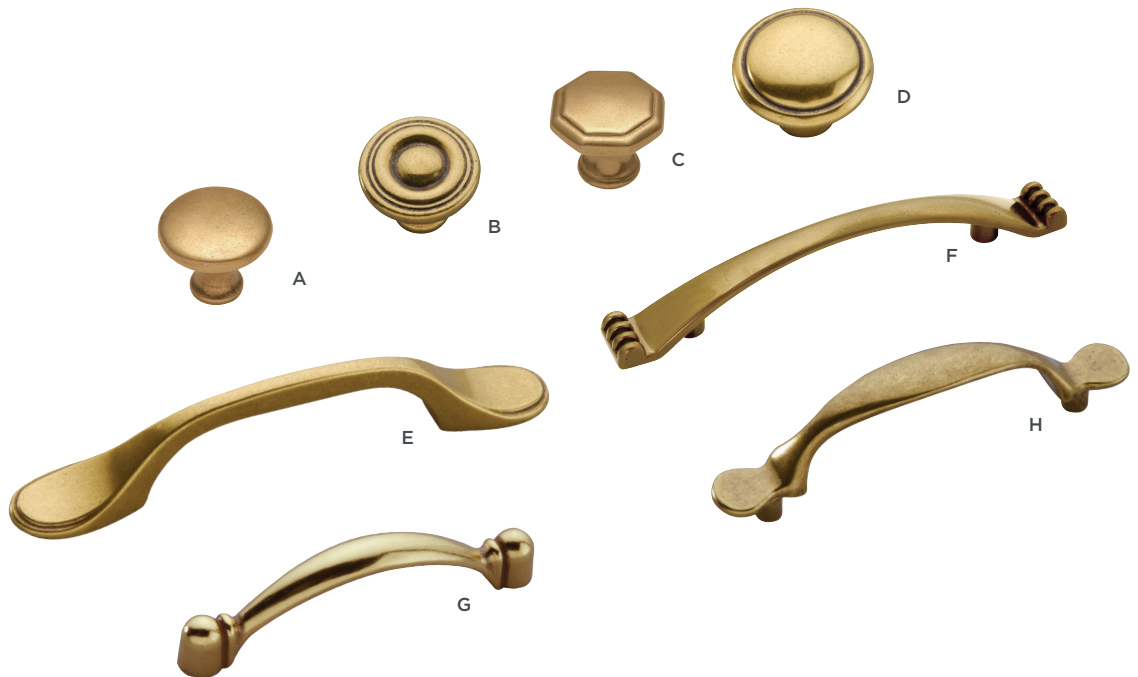

# CONQUEST

PRODUCT SPECIFICATIONS							PART NUMBER	FINISH CODE							
C/C	L	W	P	D	B	Chrome		Satin Nickel	Polished Brass	Lustre Brass	Veneti Bronze	Vintage Bronze	Oil-Rubbed Bronze Highlighted	White	
A	-	-	-	1"	1-1/8"	1/2"	P14255-	26	SN	3	LB	VBZ	VB	OBH	W
B	-	-	-	15/16"	1-3/16"	5/8"	P14402-	26	SN	3	LB	VBZ	VB	-	W
C	-	-	-	1"	1-1/8"	11/16"	P14004-	26	SN	3	LB	VBZ	-	-	-
D	-	-	-	1-1/16"	1-3/8"	5/8"	P14848-	26	SN	3	LB	VBZ	VB	-	W
E	3"	5"	11/16"	1"	-	-	P14444-	26	SN	3	LB	VBZ	-	OBH	W
F	3"	4-1/2"	9/16"	3/4"	-	-	P14461-	26	SN	-	LB	VBZ	-	-	-
G	3"	3-3/8"	3/4"	7/8"	-	-	P14441-	26	SN	3	LB	-	-	-	-
H	3"	4"	1/2"	7/8"	-	-	P14170-	26	SN	3	LB	VBZ	-	-	W
I	3"	5"	1/2"	1"	-	-	P14174-	26	SN	3	-	VBZ	-	-	W
J	3"	3-1/4"	3/8"	1"	-	-	P14451-	26	SN	3	-	-	-	-	W
K	-	-	-	1"	1-1/8"	3/4"	P14630-	-	-	-	-	-	-	-	W
L	-	-	-	1-1/4"	1-1/4"	5/8"	P14021-	-	-	-	-	-	-	-	W

Record the "Part Number" including the hyphen followed by the "Finish Code." Example: HH075422-VB

TRANSITIONAL

## VENETI BRONZE

54% Scale

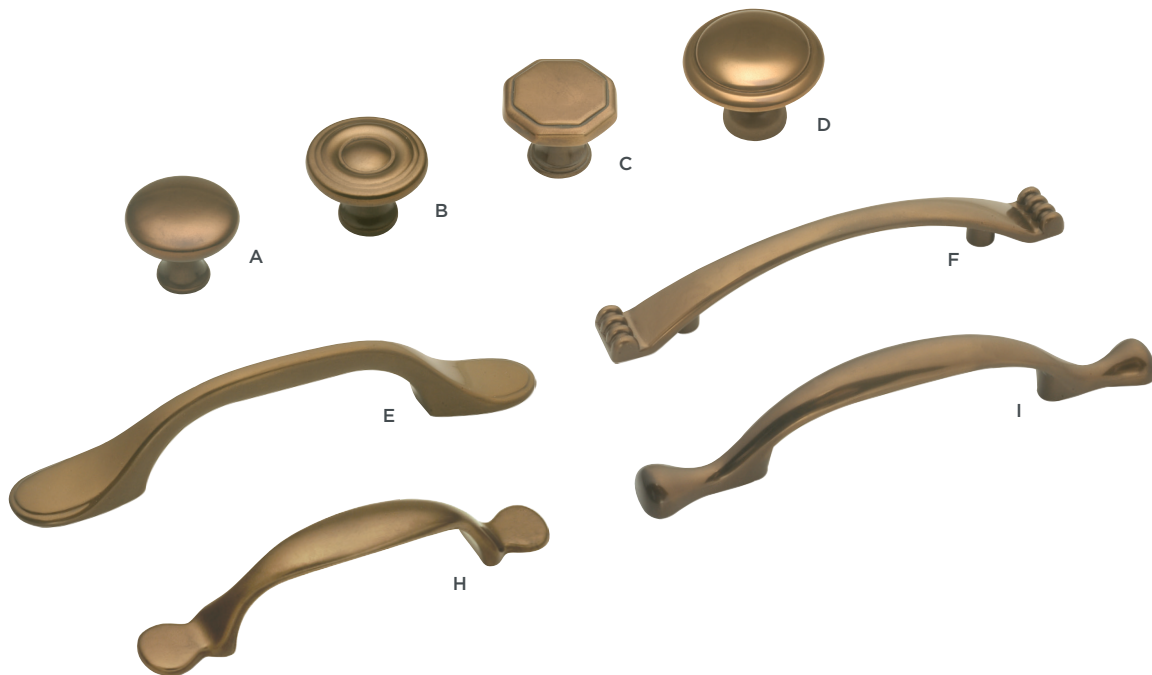

VINTAGE BRONZE  
54% Scale



OIL-RUBBED BRONZE HIGHLIGHTED  
54% Scale



WHITE  
54% Scale

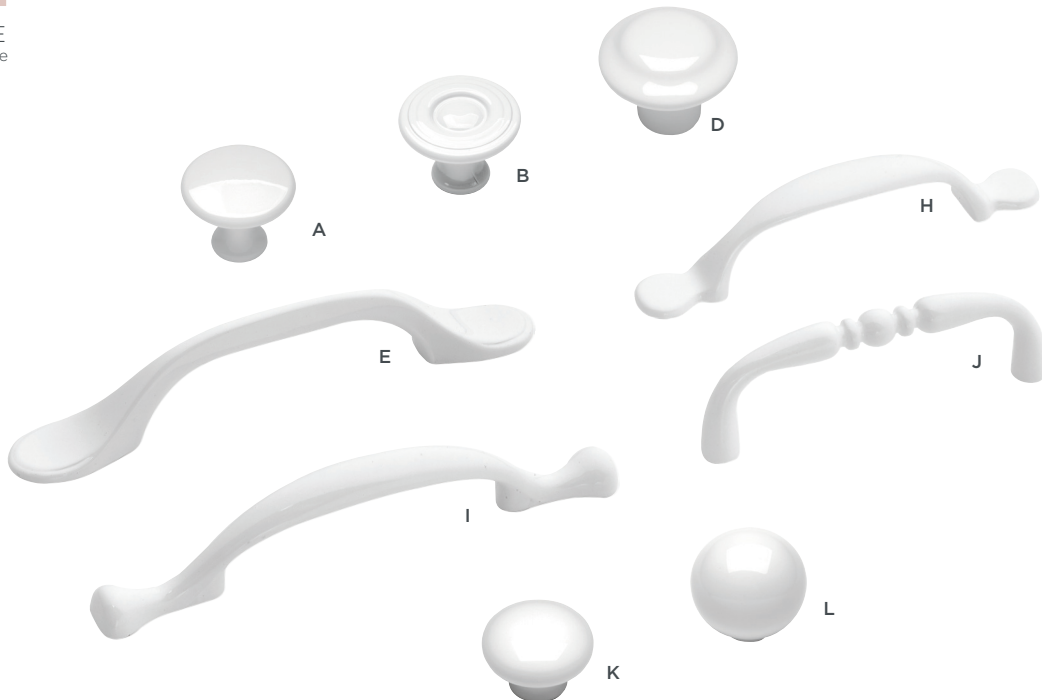

# MODUS

	PRODUCT SPECIFICATIONS						PART NUMBER	FINISH CODE		
	C/C	L	W	P	D	B		Windover Antique	Matte Black	Satin Nickel
<b>A</b>	-	-	-	1-1/8"	3/4"	3/4"	PA1211-	WOA	-	-
<b>B</b>	-	-	-	1-1/8"	1-3/8"	3/4"	PA1214-	WOA	-	-
<b>C</b>	-	-	-	7/8"	1-1/4"	3/8"	PA1213-	WOA	-	-
<b>D</b>	-	-	-	1-3/32"	SQ:1-7/16"	7/16" SQ.	P3180-	WOA	-	-
<b>E</b>	-	-	-	1-1/8"	1-1/4"	5/8"	PA1218-	WOA	MB	SN
<b>F</b>	-	-	-	1"	1-1/4"	7/8"	PA1216-	WOA	-	-
<b>G</b>	2-3/4"	3-1/4"	1-3/8"	3/4"	-	-	PA1021-	WOA	-	-
<b>H</b>	3"	3-3/4"	1-3/8"	1"	-	-	PA1023-	WOA	-	-
<b>I</b>	64mm	4"	1-5/8"	3/4"	-	-	PA1022-	WOA	-	-
<b>J</b>	-	-	-	1"	1"	5/8"	PA1217-	-	MB	SN
<b>K</b>	2-3/4"	3-3/16"	1-5/16"	3/4"	-	-	P2626-	-	MB	-

Record the "Part Number" including the hyphen followed by the "Finish Code." Example: HH075422-VB



@housebyhoff

SATIN NICKEL  
54% Scale

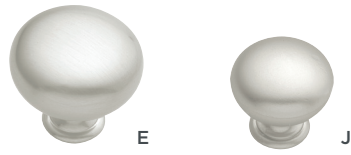

WINDOVER ANTIQUE  
54% Scale



MATTE BLACK  
54% Scale



---

# TRADITIONAL

Characterized by ornate and decorative elements in design, calling back to old world glamour and luxury, when richness in detail emphasized the hand crafting required for such finery.





TRADITIONAL

# ALTAIR

	PRODUCT SPECIFICATIONS					PART NUMBER	FINISH CODE		
	C/C	L	W	P	B		Satin Antique Silver	Black Nickel Viced	Vintage Bronze
<b>A</b>	3" & 96mm	4-1/2"	13/16"	1-1/8"	-	P3601-	SAS	BNV	VB
<b>B</b>	-	1"	1"	1-1/8"	5/16" SQ	P3503-	SAS	BNV	VB
<b>C</b>	-	1-3/4"	1-1/8"	1"	1-3/8" x 3/4"	P3600-	SAS	BNV	VB
<b>D</b>		1-1/4"	1-1/4"	1"	3/8"	P3094-	SAS	-	-

Record the "Part Number" including the hyphen followed by the "Finish Code." Example: HH075422-VB

## SATIN ANTIQUE SILVER

54% Scale

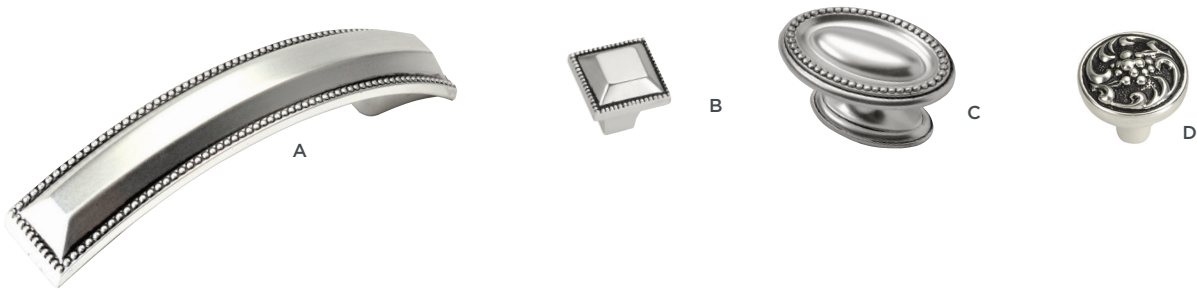

## BLACK NICKEL VIBED

54% Scale



## VINTAGE BRONZE

54% Scale



PRODUCT SPECIFICATIONS					PART NUMBER	FINISH CODE		
C/C	L	W	P	B		Satin Antique Silver	Vintage Bronze	
<b>A</b>	3"	4-5/8"	1"	1-1/16"	-	P3431-	SAS	VB
<b>B</b>	96mm	5-7/16"	1-1/16"	1-1/8"	-	P3432-	SAS	VB
<b>C</b>	128mm	6-3/4"	1-3/16"	1-3/16"	-	P3433-	SAS	VB
<b>D</b>	-	1-5/16"	1-1/8"	1-1/16"	7/8"	P3430-	SAS	VB

Record the "Part Number" including the hyphen followed by the "Finish Code." Example: HH075422-VB

SATIN ANTIQUE SILVER  
54% Scale

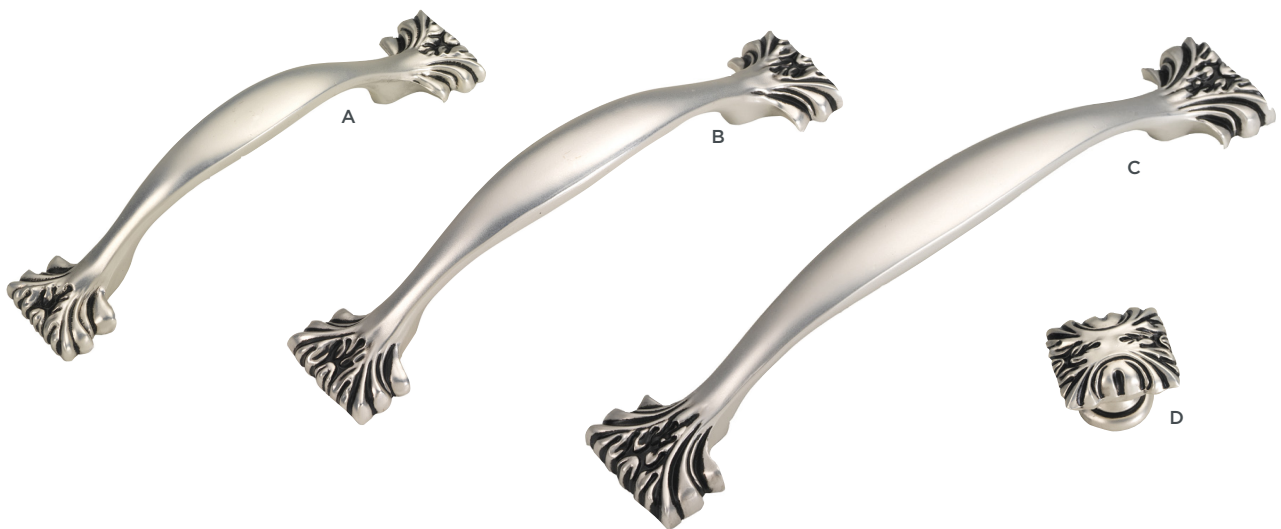

VINTAGE BRONZE  
54% Scale



# SOMERSET

	PRODUCT SPECIFICATIONS						PART NUMBER	FINISH CODE		
	C/C	L	W	P	D	B		Satin Nickel	Black Nickel Vibed	Dark Antique Copper
<b>A</b>	-	-	-	1"	SQ:1-5/16"	15/16" SQ.	HH74639-	SN	BNV	DAC
<b>B</b>	-	-	-	1"	SQ:1-1/16"	3/4" SQ.	HH74554-	SN	BNV	DAC
<b>C</b>	3"	3-3/4"	3/4"	1-1/4"	-	-	HH74549-	SN	BNV	DAC
<b>D</b>	96mm	4-1/2"	3/4"	1-1/4"	-	-	HH74637-	SN	BNV	DAC
<b>E</b>	128mm	5-13/16"	13/16"	1-1/4"	-	-	HH74638-	SN	BNV	DAC
<b>F</b>	3", 96mm & 128mm	5-3/4"	1-1/2"	13/16"	-	-	HH74673-	SN	BNV	DAC

Record the "Part Number" including the hyphen followed by the "Finish Code." Example: HH075422-VB

## SATIN NICKEL 54% Scale

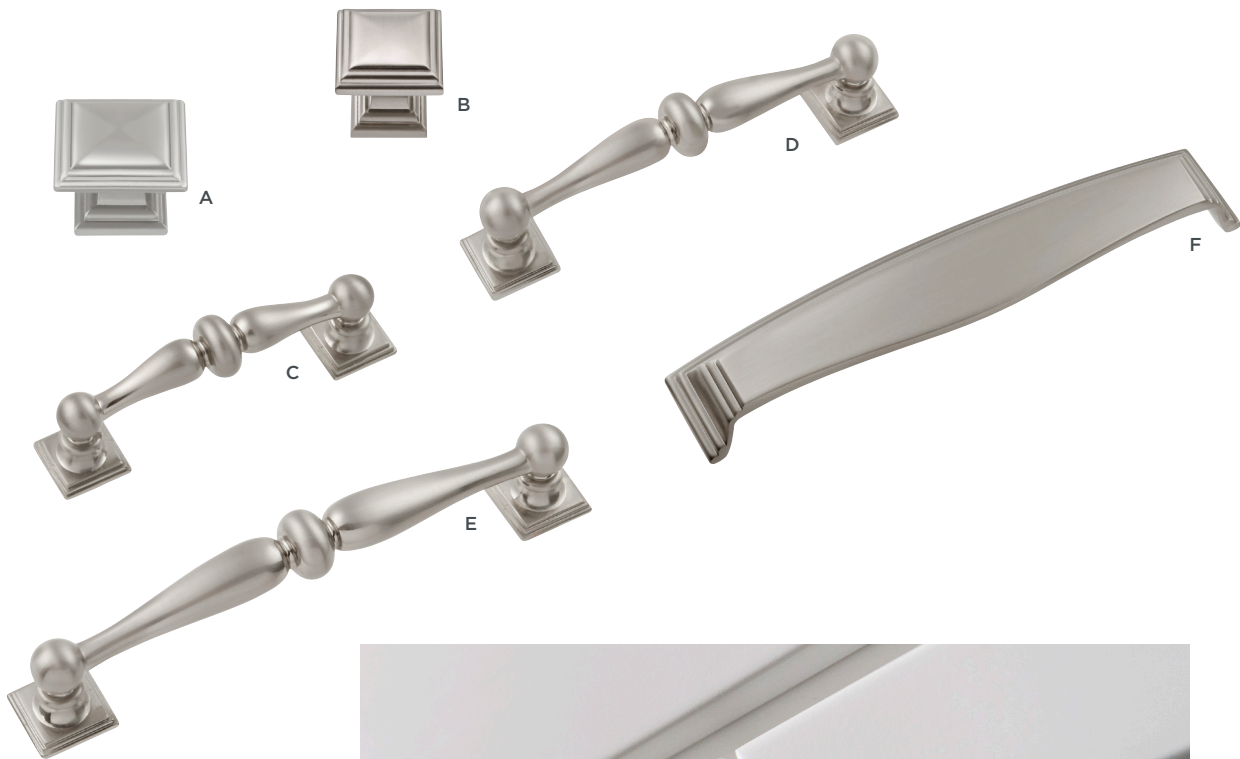

BLACK NICKEL VIBED  
54% Scale

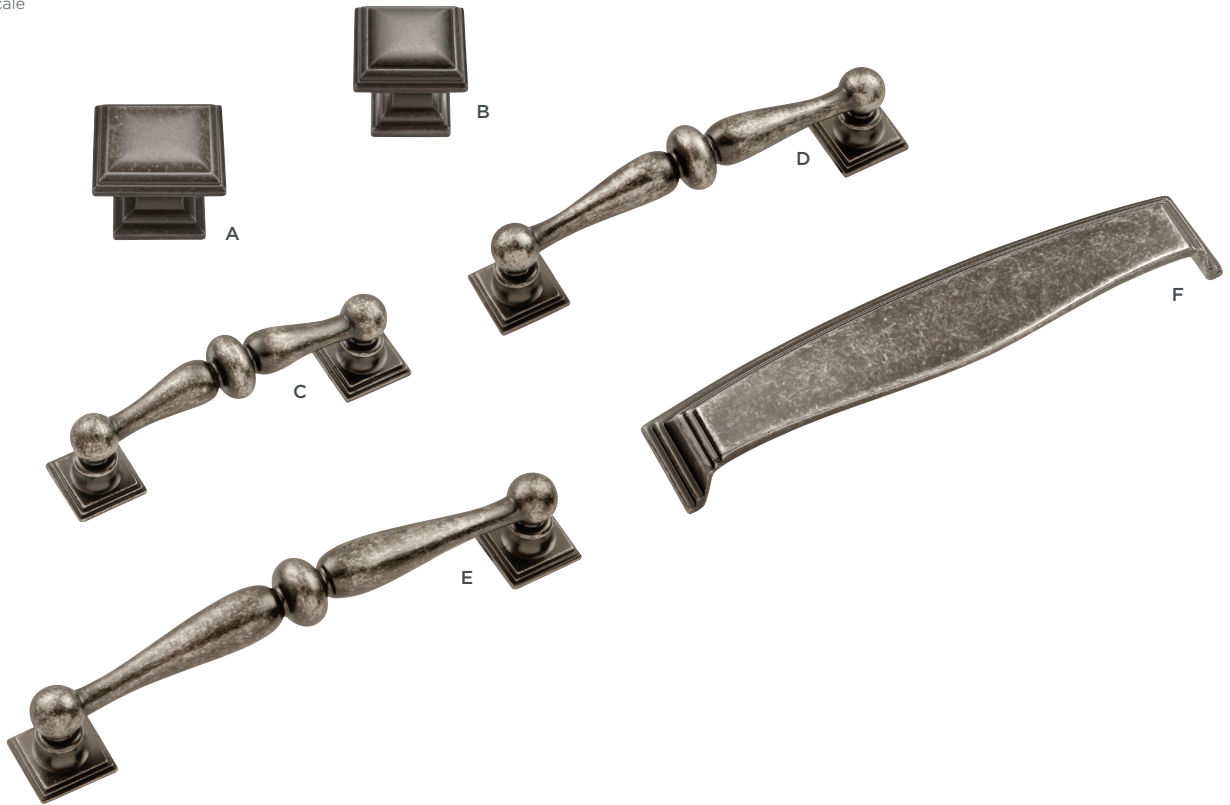

DARK ANTIQUE COPPER  
54% Scale

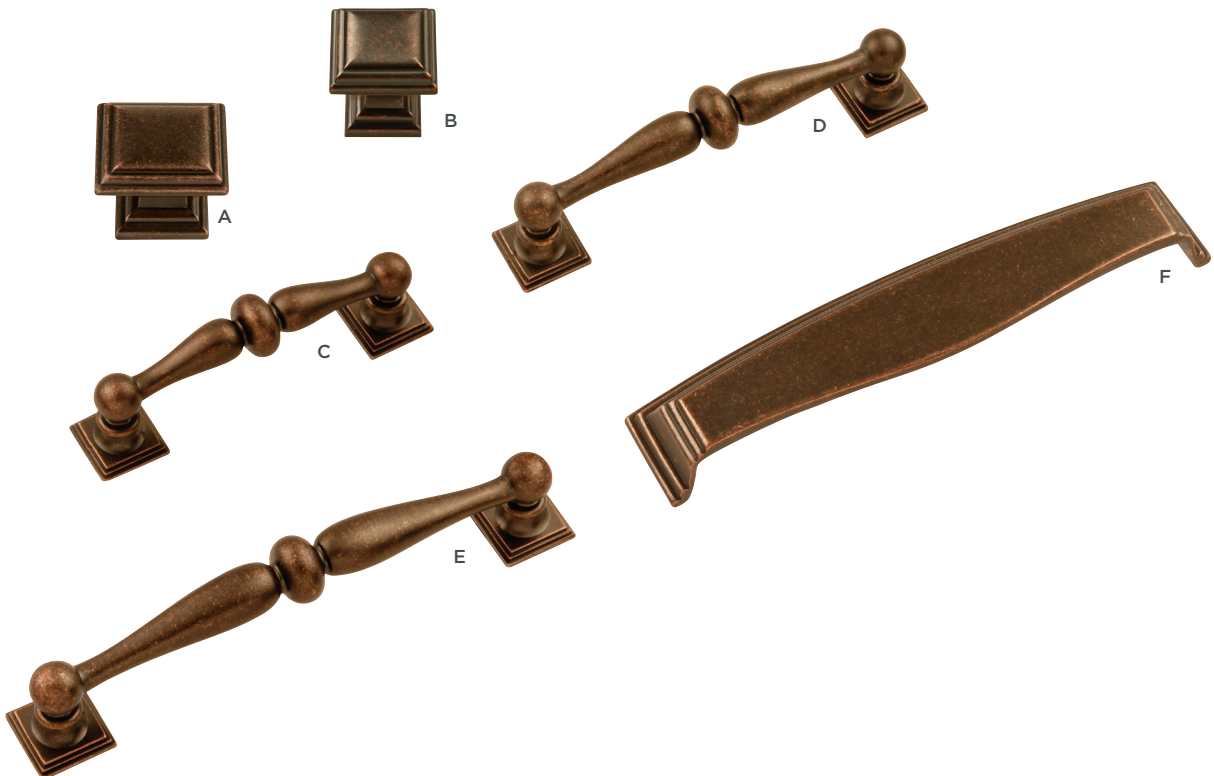



PRODUCT SPECIFICATIONS						PART NUMBER	FINISH CODE	
C/C	L	W	P	B	Black Nickel Vibed		Vintage Bronze	
<b>A</b>	128mm	6-1/2"	5/8"	1"	-	HH74630-	BNV	VB
<b>B</b>	3" & 96mm	4-3/4"	5/8"	1"	-	HH74552-	BNV	VB
<b>C</b>	-	1-1/16"	1-1/16"	1"	3/8"	HH74679-	BNV	VB
<b>D</b>	-	1-5/16"	1-5/16"	1"	3/8"	HH74670-	BNV	VB

Record the "Part Number" including the hyphen followed by the "Finish Code." Example: HH075422-VB

**BLACK NICKEL VIBED**

54% Scale

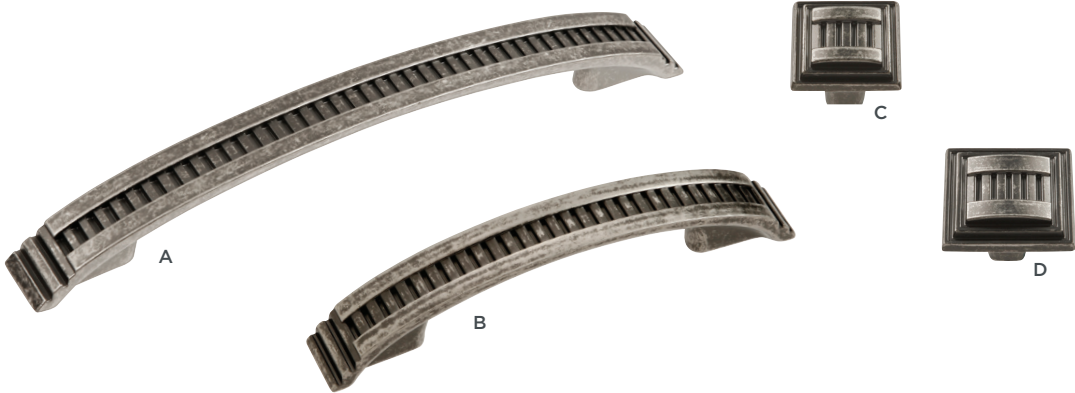

**VINTAGE BRONZE**

54% Scale

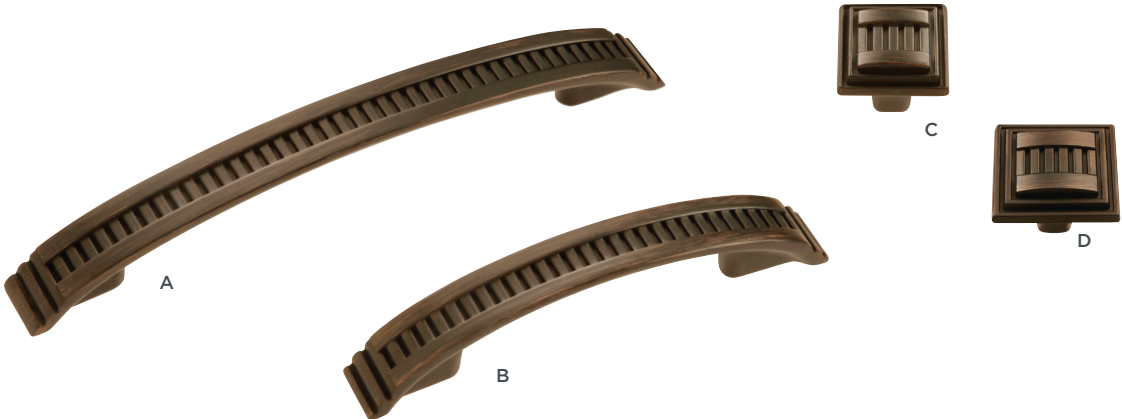

---

# TRADITIONAL SELECTIONS

A selection characterized by ornate and decorative elements in design, calling back to old world glamour and luxury, when richness in detail emphasized the hand crafting required for such finery.



	PRODUCT SPECIFICATIONS						PART NUMBER	FINISH CODE	
	C/C	L	W	P	D	B		Antique Brass	Satin Nickel
<b>A</b>	-	-	-	3/4"	1-1/2"	5/16"	P117-	AB	SN
<b>B</b>	-	-	-	7/8"	1-1/2"	1/4"	P119-	AB	SN
<b>C</b>	-	-	-	1-1/4"	11/16"	3/8"	P121-	AB	SN
<b>D</b>	-	-	-	3/4"	1-1/2"	5/16"	P126-	AB	SN
<b>E</b>	3"	4-1/8"	1/2"	3/4"	-	-	P128-	AB	SN
<b>F</b>	4-1/4"	5-3/4"	1"	1"	-	-	P132-	AB	SN
<b>G</b>	-	-	-	1/8"	2-3/8"	-	P138-	AB	SN
<b>H</b>	3"	4-3/8"	3/4"	3/4"	-	-	P118-	AB	-
<b>I</b>	3"	5-1/2"	5/8"	3/4"	-	-	P131-	AB	-
<b>J</b>	3"	4-1/4"	3/4"	7/8"	-	-	P133-	AB	-

Record the "Part Number" including the hyphen followed by the "Finish Code." Example: HH075422-VB

## SATIN NICKEL

54% Scale

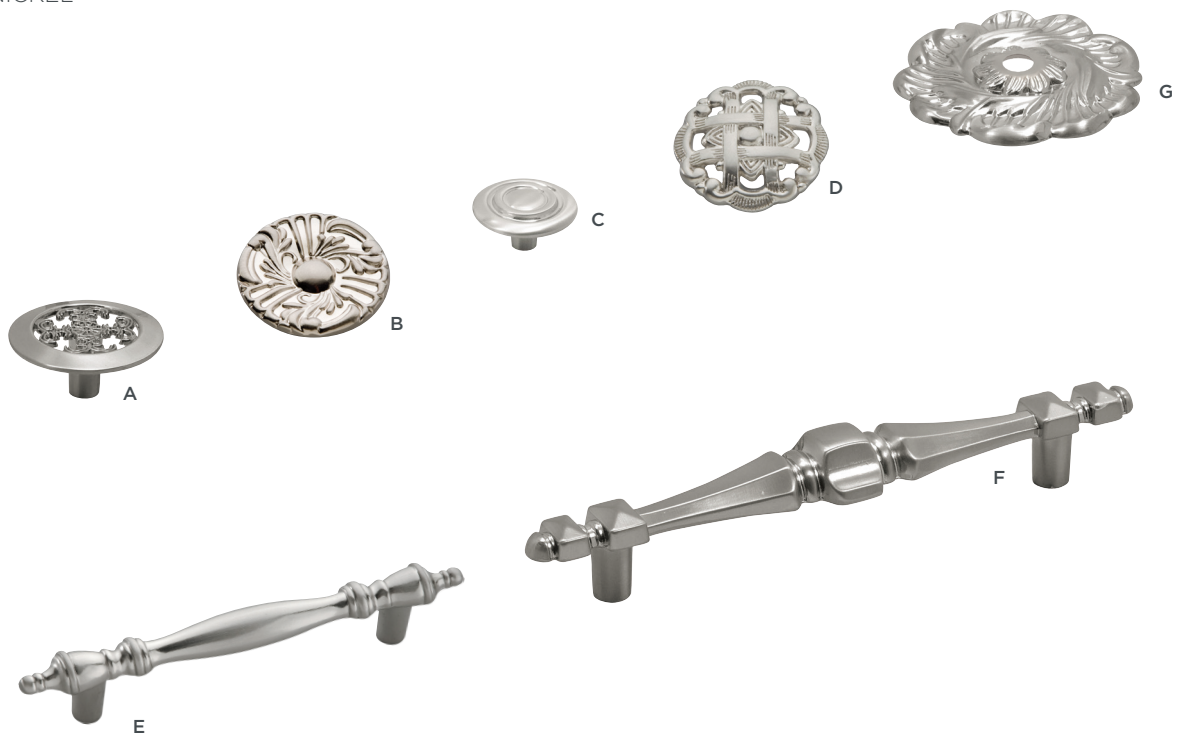

# CAVALIER

PRODUCT SPECIFICATIONS							PART NUMBER	FINISH CODE	
C/C	L	W	P	D	B		Antique Brass	Satin Nickel	
A	-	-	3/4"	1-1/2"	5/16"	P117-	AB	SN	
B	-	-	7/8"	1-1/2"	1/4"	P119-	AB	SN	
C	-	-	1-1/4"	11/16"	3/8"	P121-	AB	SN	
D	-	-	3/4"	1-1/2"	5/16"	P126-	AB	SN	
E	3"	4-1/8"	1/2"	3/4"	-	P128-	AB	SN	
F	4-1/4"	5-3/4"	1"	1"	-	P132-	AB	SN	
G	-	-	1/8"	2-3/8"	-	P138-	AB	SN	
H	3"	4-3/8"	3/4"	3/4"	-	P118-	AB	-	
I	3"	5-1/2"	5/8"	3/4"	-	P131-	AB	-	
J	3"	4-1/4"	3/4"	7/8"	-	P133-	AB	-	

Record the "Part Number" including the hyphen followed by the "Finish Code." Example: HH075422-VB

## ANTIQUE BRASS

54% Scale



PRODUCT SPECIFICATIONS					PART NUMBER	FINISH CODE	
C/C	L	W	P	B		Stainless Steel	
<b>A</b>	3"	3-13/16"	9/16"	1"	-	P3456-	SS
<b>B</b>	-	1-1/8"	1-1/8"	15/16"	5/16"	P3455-	SS

Record the "Part Number" including the hyphen followed by the "Finish Code." Example: HH075422-VB

## STAINLESS STEEL

54% Scale



# CRYSTAL PALACE

PRODUCT SPECIFICATIONS							PART NUMBER	FINISH CODE			
C/C	L	W	P	D	B	Crysaacrylic with Polished Nickel		Glass with Satin Nickel	Lucite	Glass with Chrome	
<b>A</b>	3"	4-3/4"	3/4"	1-1/2"	-	-	HH075857-	CA14	-	-	-
<b>B</b>	-	-	-	1-1/4"	1-1/8"	13/16"	HH74687-	CA14	-	-	-
<b>C</b>	-	-	-	1-1/8"	1-3/16"	7/8"	HH74688-	CA14	-	-	-
<b>D</b>	-	-	-	1-3/8"	1-1/4"	3/4"	HH74689-	CA14	-	-	-
<b>E</b>	-	1-1/4"	3/4"	1-1/2"	-	7/8"	HH075852-	-	GLSN	-	-
<b>F</b>	-	-	-	1-11/16"	1-3/8"	7/8"	HH075853-	-	GLSN	-	-
<b>G</b>	-	-	-	1-1/2"	1-1/4"	1/2"	HH075854-	-	-	-	GLCH
<b>H</b>	-	-	-	1-1/4"	1-1/4"	3/4"	HH075855-	-	-	-	GLCH
<b>I</b>	-	-	-	1-5/8"	1-1/4"	7/8"	HH075809-	-	-	-	GLCH
<b>J</b>	-	-	-	1-1/2"	1-3/16"	9/16"	P705-	-	-	LU	-

Record the "Part Number" including the hyphen followed by the "Finish Code." Example: HH075422-VB

## CRYSACRYLIC WITH POLISHED NICKEL 54% Scale

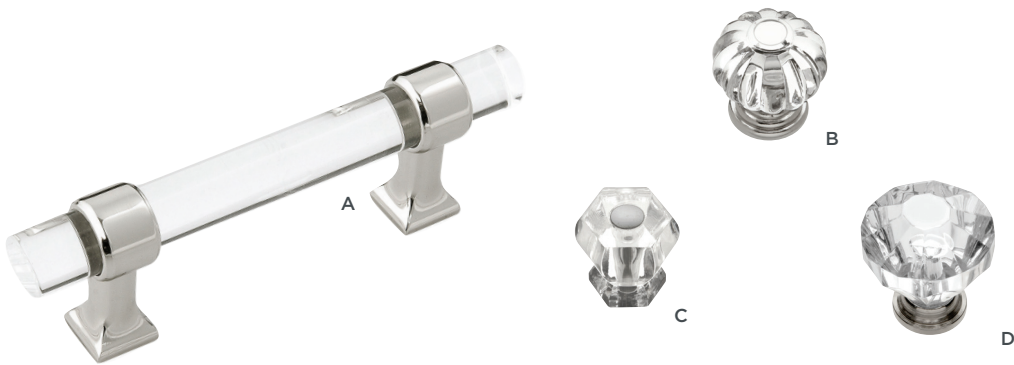

## GLASS WITH SATIN NICKEL 54% Scale



## LUCITE 54% Scale



## GLASS WITH CHROME 54% Scale



PRODUCT SPECIFICATIONS						PART NUMBER	FINISH CODE	
C/C	L	W	P	D	B		Satin Nickel	Oil-Rubbed Bronze Highlighted
<b>A</b>	-	-	1"	1-1/4"	1"	P3101-	SN	OBH
<b>B</b>	-	-	1"	1-1/4"	5/8"	P3103-	SN	OBH
<b>C</b>	96mm	4-3/8"	1"	1"	-	P3104-	SN	OBH
<b>D</b>	3-1/2"	4-3/8"	1"	1"	-	P3100-	SN	OBH
<b>E</b>	4-1/2"	5"	1-1/16"	7/8"	-	P3303-	SN	-

Record the "Part Number" including the hyphen followed by the "Finish Code." Example: HH075422-VB

SATIN NICKEL  
54% Scale



OIL-RUBBED BRONZE HIGHLIGHTED  
54% Scale

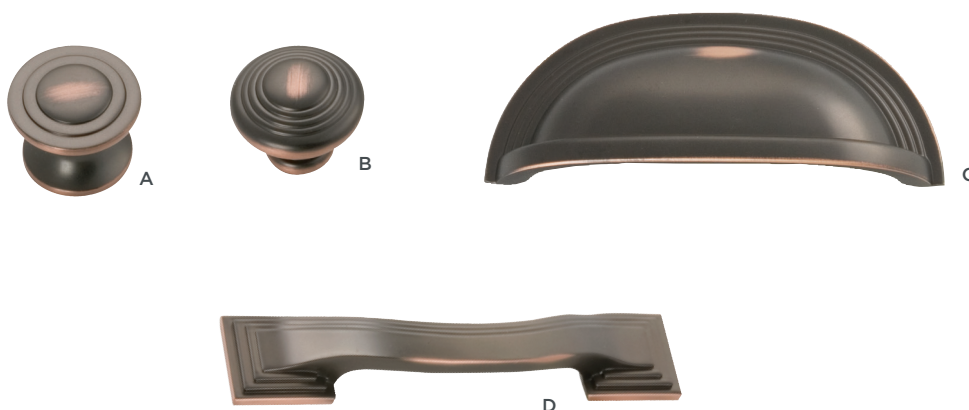

# ECLIPSE

	PRODUCT SPECIFICATIONS						PART NUMBER	FINISH CODE				
	C/C	L	W	P	D	B		Chrome	Satin Nickel	Antique Brass	Windover Antique	Vintage Bronze
<b>A</b>	3"	4-3/4"	1/2"	15/16"	-	-	P135-	-	SN	AB	WOA	VB
<b>B</b>	3"	4-1/4"	5/8"	15/16"	-	-	P330-	26	-	-	WOA	VB
<b>C</b>	-	-	-	1-3/8"	1-1/4"	7/8"	P548-	CH	-	-	-	-
<b>D</b>	-	-	-	1-3/16"	1-1/8"	3/4"	P320-	26	-	-	-	-
<b>E</b>	3"	3-7/8"	3/8"	3/4"	-	-	P14114-	26	-	-	WOA	VB
<b>F</b>	3"	4-3/4"	1/2"	1"	-	-	P333-	26	-	-	-	-
<b>G</b>	3"	4-1/16"	1/2"	1"	-	-	P335-	26	-	-	-	-
<b>H</b>	-	-	-	7/8"	1-1/4"	3/8"	P413-	-	-	-	-	VB
<b>I</b>	3"	4-7/16"	15/16"	15/16"	-	-	P431-	-	-	-	-	VB

Record the "Part Number" including the hyphen followed by the "Finish Code." Example: HH075422-VB

## CHROME

54% Scale

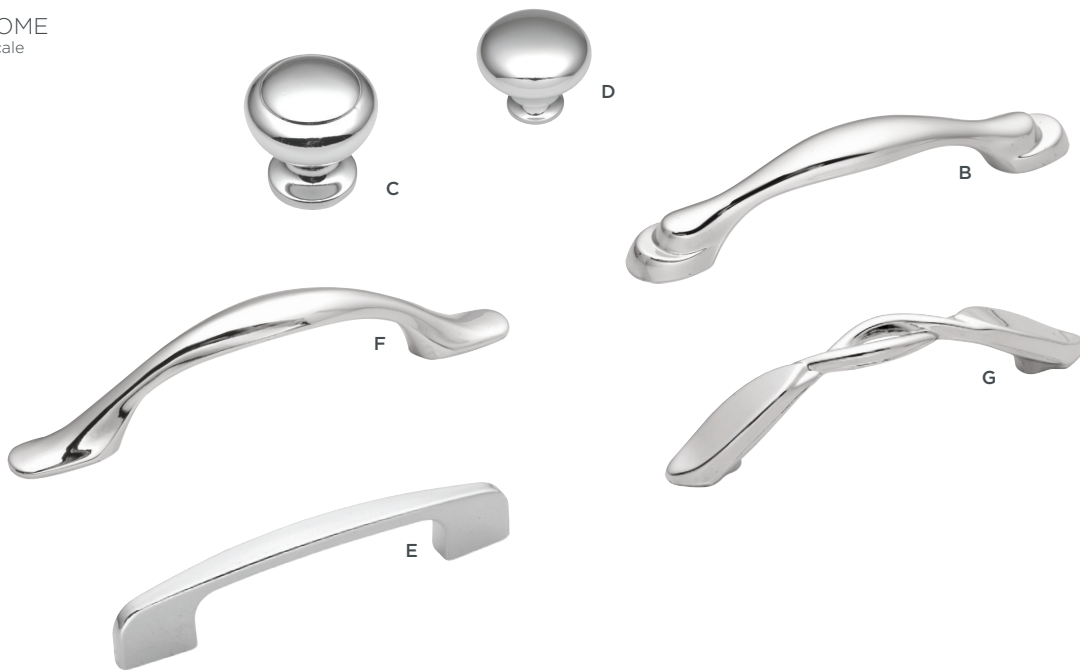

## SATIN NICKEL

54% Scale



ANTIQUE BRASS  
54% Scale



WINDOVER ANTIQUE  
54% Scale



VINTAGE BRONZE  
54% Scale



# FRENCH COUNTRY

PRODUCT SPECIFICATIONS							PART NUMBER	FINISH CODE
C/C	L	W	P	D	B		Vintage Bronze	
A	-	-	1-3/8"	1-5/16"	3/4"	P3163-	VB	
B	-	-	1"	1-1/4"	3/8"	P7343-	VB	
C	3"	3-3/8"	7/16"	1-1/8"	-	P3608-	VB	
D	128mm	5-1/2"	1/2"	1-1/8"	-	P7344-	VB	

Record the "Part Number" including the hyphen followed by the "Finish Code." Example: HH075422-VB

## VINTAGE BRONZE

54% Scale



# FRENCH TWIST

PRODUCT SPECIFICATIONS						FINISH CODE	
C/C	L	W	P	B	PART NUMBER	Dark Antique Copper	Black Iron
A	2-1/8"	3/4"	1"	5/16"	P3450-	DAC	BI
B	3"	5-11/16"	7/8"	1"	P3451-	DAC	BI

Record the "Part Number" including the hyphen followed by the "Finish Code." Example: HH075422-VB

## DARK ANTIQUE COPPER

54% Scale



## BLACK IRON

54% Scale







TRADITIONAL

# MANOR HOUSE

TRADITIONAL

	PRODUCT SPECIFICATIONS						PART NUMBER	FINISH CODE			
	C/C	L	W	P	D	B		Satin Nickel	Silver Stone	Lancaster Hand Polish	Dark Antique Copper
<b>A</b>	-	-	-	15/16"	1-1/4"	5/8"	P8196-	-	ST	LP	DAC
<b>B</b>	3"	5-13/16"	1-3/4"	3/4"	-	-	P8157-	-	ST	-	DAC
<b>C</b>	2-1/2"	3-1/2"	1-3/4"	5/8"	-	-	P8048-	-	ST	LP	DAC
<b>D</b>	3"	4"	2"	1/2"	-	-	P8049-	-	ST	LP	DAC
<b>E</b>	3"	3-1/2"	1/2"	15/16"	-	-	P577-	SN	-	-	-
<b>F</b>	3"	5"	7/8"	1/8"	-	-	P513-	SN	-	-	-
<b>G</b>	-	2-5/8"	1-5/8"	9/16"	-	-	P8165-	-	-	LP	-
<b>H</b>	-	-	-	3/4"	1"	5/8"	P8011-	-	-	LP	-
<b>I</b>	-	1-1/8"	1/2"	1-3/16"	-	1/2"	P8007-	-	-	LP	-
<b>J</b>	-	-	-	1"	1-1/4"	7/8"	P406-	-	-	LP	-
<b>K</b>	-	-	-	13/16"	1-5/8"	9/16"	P201-	-	-	LP	-
<b>L</b>	-	3"	1-1/8"	3/16"	-	-	P277-	-	-	LP	-
<b>M</b>	-	-	-	3/16"	1-7/8"	-	P282-	-	-	LP	-
<b>N</b>	-	-	-	1/2"	1/2"	7/16"	P318-	-	-	LP	-
<b>O</b>	-	2-1/2"	1-1/4"	1/2"	-	1"	P8005-	-	-	LP	-
<b>P</b>	3"	4"	3"	1/2"	-	-	P329-	-	ST	LP	-
<b>Q</b>	-	5-1/2"	1"	1/8"	-	-	P326-	-	ST	LP	-
<b>R</b>	-	1-1/8"	1/4"	5/8"	-	5/8"	P321-	-	ST	LP	-
<b>S</b>	2"	2"	3"	1/2"	-	-	P8258-	-	-	LP	-
<b>T</b>	2-1/2"	2-1/4"	3-5/8"	1/2"	-	-	P8257-	-	-	LP	-
<b>U</b>	-	1-7/8"	1-1/2"	3/8"	1-1/8"	-	P8018-	-	-	LP	-
<b>V</b>	-	-	-	3/4"	1-1/8"	1/2"	P3473-	-	ST	-	-
<b>W</b>	3-1/2"	4-1/8"	1-3/4"	3/8"	-	-	P3477-	-	ST	-	-
<b>X</b>	3"	5-1/4"	2-1/2"	1/2"	-	-	P252-	-	-	LP	-
<b>Y</b>	-	6"	3/4"	1/8"	-	-	P8169-	-	-	LP	-

Record the "Part Number" including the hyphen followed by the "Finish Code." Example: HH075422-VB

**SATIN NICKEL**  
54% Scale



**SILVER STONE**  
54% Scale



SILVER STONE  
54% Scale



LANCASTER HAND POLISH  
54% Scale



# MANOR HOUSE

	PRODUCT SPECIFICATIONS						PART NUMBER	FINISH CODE			
	C/C	L	W	P	D	B		Satin Nickel	Silver Stone	Lancaster Hand Polish	Dark Antique Copper
<b>A</b>	-	-	-	15/16"	1-1/4"	5/8"	P8196-	-	ST	LP	DAC
<b>B</b>	3"	5-13/16"	1-3/4"	3/4"	-	-	P8157-	-	ST	-	DAC
<b>C</b>	2-1/2"	3-1/2"	1-3/4"	5/8"	-	-	P8048-	-	ST	LP	DAC
<b>D</b>	3"	4"	2"	1/2"	-	-	P8049-	-	ST	LP	DAC
<b>E</b>	3"	3-1/2"	1/2"	15/16"	-	-	P577-	SN	-	-	-
<b>F</b>	3"	5"	7/8"	1/8"	-	-	P513-	SN	-	-	-
<b>G</b>	-	2-5/8"	1-5/8"	9/16"	-	-	P8165-	-	-	LP	-
<b>H</b>	-	-	-	3/4"	1"	5/8"	P8011-	-	-	LP	-
<b>I</b>	-	1-1/8"	1/2"	1-3/16"	-	1/2"	P8007-	-	-	LP	-
<b>J</b>	-	-	-	1"	1-1/4"	7/8"	P406-	-	-	LP	-
<b>K</b>	-	-	-	13/16"	1-5/8"	9/16"	P201-	-	-	LP	-
<b>L</b>	-	3"	1-1/8"	3/16"	-	-	P277-	-	-	LP	-
<b>M</b>	-	-	-	3/16"	1-7/8"	-	P282-	-	-	LP	-
<b>N</b>	-	-	-	1/2"	1/2"	7/16"	P318-	-	-	LP	-
<b>O</b>	-	2-1/2"	1-1/4"	1/2"	-	1"	P8005-	-	-	LP	-
<b>P</b>	3"	4"	3"	1/2"	-	-	P329-	-	ST	LP	-
<b>Q</b>	-	5-1/2"	1"	1/8"	-	-	P326-	-	ST	LP	-
<b>R</b>	-	1-1/8"	1/4"	5/8"	-	5/8"	P321-	-	ST	LP	-
<b>S</b>	2"	2"	3"	1/2"	-	-	P8258-	-	-	LP	-
<b>T</b>	2-1/2"	2-1/4"	3-5/8"	1/2"	-	-	P8257-	-	-	LP	-
<b>U</b>	-	1-7/8"	1-1/2"	3/8"	1-1/8"	-	P8018-	-	-	LP	-
<b>V</b>	-	-	-	3/4"	1-1/8"	1/2"	P3473-	-	ST	-	-
<b>W</b>	3-1/2"	4-1/8"	1-3/4"	3/8"	-	-	P3477-	-	ST	-	-
<b>X</b>	3"	5-1/4"	2-1/2"	1/2"	-	-	P252-	-	-	LP	-
<b>Y</b>	-	6"	3/4"	1/8"	-	-	P8169-	-	-	LP	-

Record the "Part Number" including the hyphen followed by the "Finish Code." Example: HH075422-VB

## DARK ANTIQUE COPPER

54% Scale

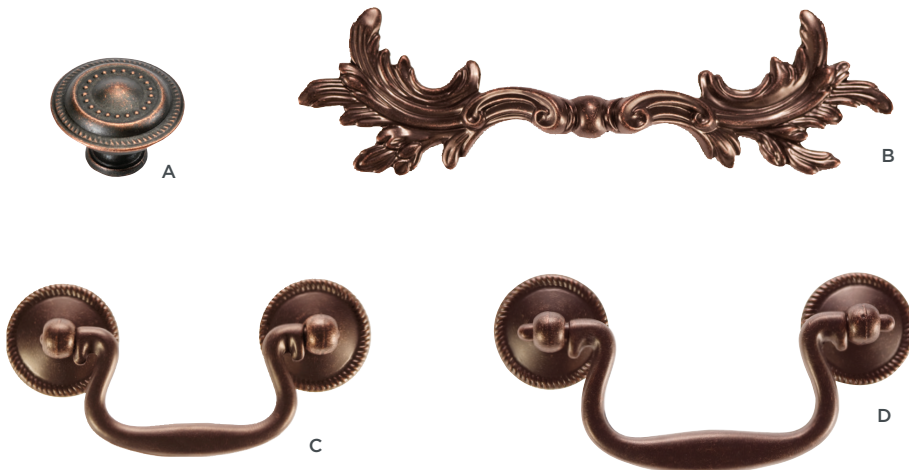

PRODUCT SPECIFICATIONS							PART NUMBER	FINISH CODE
C/C	L	W	P	D	B		Refined Bronze	
<b>A</b>	-	-	7/8"	1-1/4"	5/16"	P3091-	RB	
<b>B</b>	-	-	1-1/8"	1-1/4"	3/8"	P3094-	RB	
<b>C</b>	96mm	4-3/4"	5/8"	1-1/4"	-	P3092-	RB	
<b>D</b>	-	-	1-1/16"	1-3/8"	3/8"	P3093-	RB	
<b>E</b>	3" & 96mm	5"	1/2"	1"	-	P3090-	RB	

Record the "Part Number" including the hyphen followed by the "Finish Code." Example: HH075422-VB

REFINED BRONZE  
54% Scale

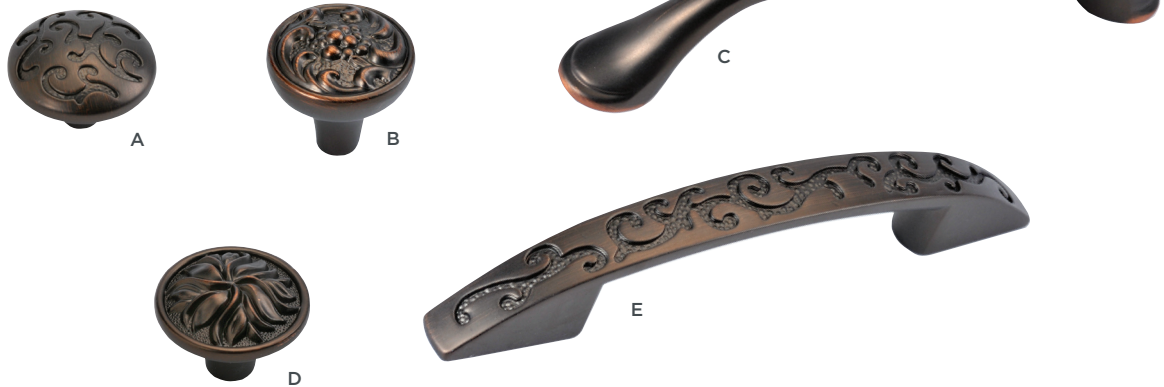

PALMETTO

PRODUCT SPECIFICATIONS						PART NUMBER	FINISH CODE
C/C	L	W	P	B		Windover Antique	
<b>A</b>	3"	4"	2"	5/8"	-	PA0924-	WOA
<b>B</b>	3"	4-1/2"	2-3/4"	1/2"	-	PA0923-	WOA

Record the "Part Number" including the hyphen followed by the "Finish Code." Example: HH075422-VB

WINDOVER ANTIQUE  
54% Scale



# RAVEL

PRODUCT SPECIFICATIONS							PART NUMBER	FINISH CODE
C/C	L	W	P	D	B		Satin Nickel	
A	-	1-3/16"	1-3/16"	1"	-	5/16"	P3453-	SN
B	3"	3-7/16"	1/2"	1"	-	-	P3454-	SN

Record the "Part Number" including the hyphen followed by the "Finish Code." Example: HH075422-VB

## SATIN NICKEL

54% Scale



# ROMA

PRODUCT SPECIFICATIONS							PART NUMBER	FINISH CODE	
C/C	L	W	P	D	B		Black Nickel Vibed	Vintage Bronze	
A	-	-	3/4"	1-1/2"	5/16"	P3460-	BNV	VB	
B	-	-	1"	1-1/4"	5/16"	P3461-	BNV	VB	
C	3"	5-11/16"	1/2"	1-1/8"	-	P3463-	BNV	VB	

Record the "Part Number" including the hyphen followed by the "Finish Code." Example: HH075422-VB

## BLACK NICKEL VIBED

54% Scale

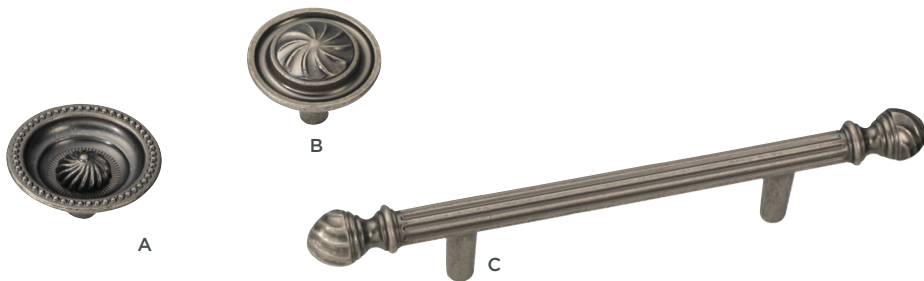

## VINTAGE BRONZE



PRODUCT SPECIFICATIONS							PART NUMBER	FINISH CODE			
C/C	L	W	P	D	B	Black		Satin Nickel with Black	White Porcelain with Chrome	Satin Nickel with White	
<b>A</b>	-	-	-	1-3/16"	1-3/8"	5/8"	P638-	BL	-	-	-
<b>B</b>	3"	5"	3/4"	1-3/16"	-	-	P796-	-	SNB	CH	-
<b>C</b>	-	-	-	15/16"	1-1/4"	5/8"	P222-	-	SNB	-	SN
<b>D</b>	-	-	-	1-1/16"	1-5/16"	11/16"	P427-	-	SNB	26W	-
<b>E</b>	-	-	-	15/16"	1-1/4"	5/16"	P710-	-	-	CH	SNW
<b>F</b>	3"	5"	3/4"	1-3/16"	-	-	P744-	-	-	-	SNW

Record the "Part Number" including the hyphen followed by the "Finish Code." Example: HH075422-VB

**BLACK**  
54% Scale

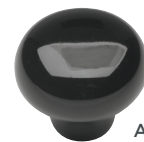

**SATIN NICKEL WITH BLACK**  
54% Scale



**WHITE PORCELAIN WITH CHROME**  
54% Scale



**SATIN NICKEL WITH WHITE**  
54% Scale



# TRANQUILITY

PRODUCT SPECIFICATIONS						PART NUMBER	FINISH CODE				
C/C	L	W	P	D	B		Pink Rose	White	Vintage Brown Crackle	Lancaster Hand Polished	
<b>A</b>	-	-	-	1"	1-3/8"	5/8"	P602-	PR	-	-	-
<b>B</b>	-	-	-	3/4"	1-1/16"	5/8"	P603-	PR	-	-	-
<b>C</b>	-	-	-	9/16"	9/16"	7/16"	P1-	-	W	-	-
<b>D</b>	-	-	-	7/8"	7/8"	5/8"	P3-	-	W	-	-
<b>E</b>	-	-	-	1"	1"	5/8"	P221-	-	-	VC	-
<b>F</b>	-	-	-	15/16"	1-1/4"	5/8"	P222-	-	-	VC	LP
<b>G</b>	-	-	-	1"	1-1/8"	5/8"	P7-	-	W	-	-
<b>H</b>	-	-	-	3/8"	2"	-	P69-	-	W	-	-
<b>I</b>	-	-	-	1"	1-1/4"	3/4"	P28-	-	W	-	-
<b>J</b>	-	-	-	1"	1-1/2"	3/4"	P29-	-	W	-	-
<b>K</b>	-	-	-	1-3/16"	1-3/8"	5/8"	P630-	-	W	-	-
<b>L</b>	3"	5"	3/4"	1-3/16"	-	-	P744-	-	W	-	-
<b>M</b>	3"	5"	3/4"	1-3/16"	-	-	P796-	-	W	-	-
<b>N</b>	3"	5"	3/4"	1-1/4"	-	-	P703-	-	W	-	-
<b>O</b>	-	-	-	1-1/16"	1-5/16"	11/16"	P427-	-	W	-	-

Record the "Part Number" including the hyphen followed by the "Finish Code." Example: HH075422-VB

TRADITIONAL

## PINK ROSE 54% Scale



## LANCASTER HAND POLISHED 54% Scale



## VINTAGE BROWN CRACKLE 54% Scale

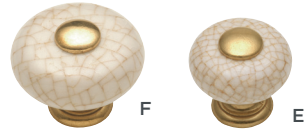

## WHITE 54% Scale

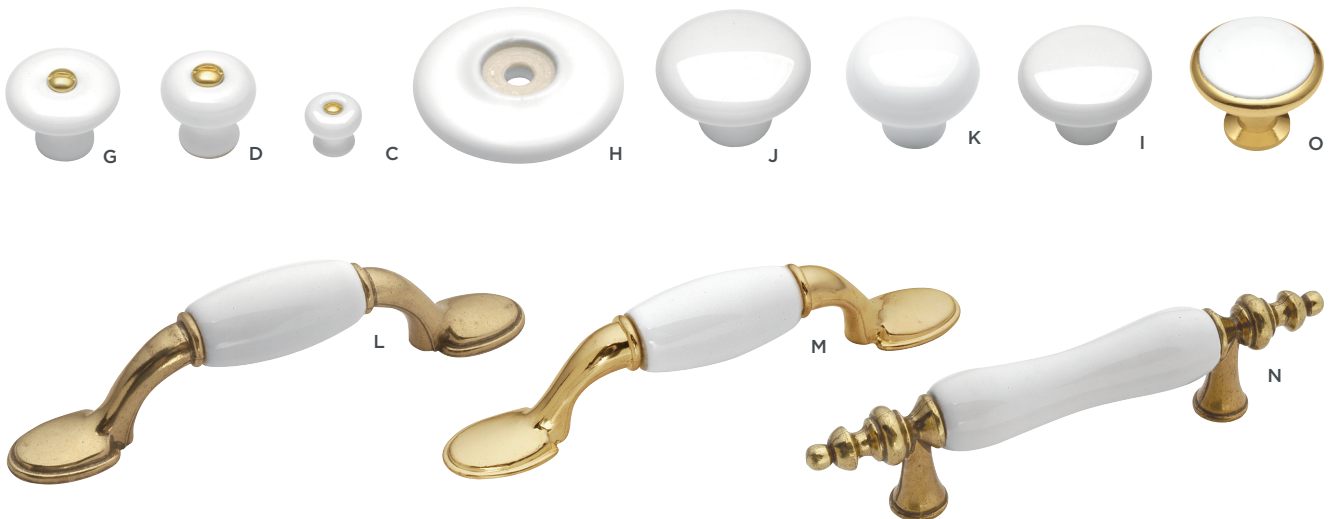





---

# RUSTIC

Craftsmanship with character, coarse in texture, keeping true to the natural state of materials.



# ARTS & CRAFTS

PRODUCT SPECIFICATIONS							PART NUMBER	FINISH CODE	
C/C	L	W	P	D	B		Antique Pewter	Windover Antique	
A	-	2-5/8"	3/4"	7/8"	-	1-1/4" x 5/16"	P7526-	AP	WDA
B	3" & 96mm	5-1/4"	3/4"	3/4"	-	-	P7525-	AP	WDA
C	3" & 96mm	5"	1-7/8"	7/8"	-	-	P7527-	AP	WDA
D	-	3-1/2"	1"	1/8"	-	-	P7529-	AP	WDA
E	-	-	-	1-1/8"	1-1/4"	3/8"	P7528-	AP	WDA

Record the "Part Number" including the hyphen followed by the "Finish Code." Example: HH075422-VB

## ANTIQUPE PEWTER 54% Scale

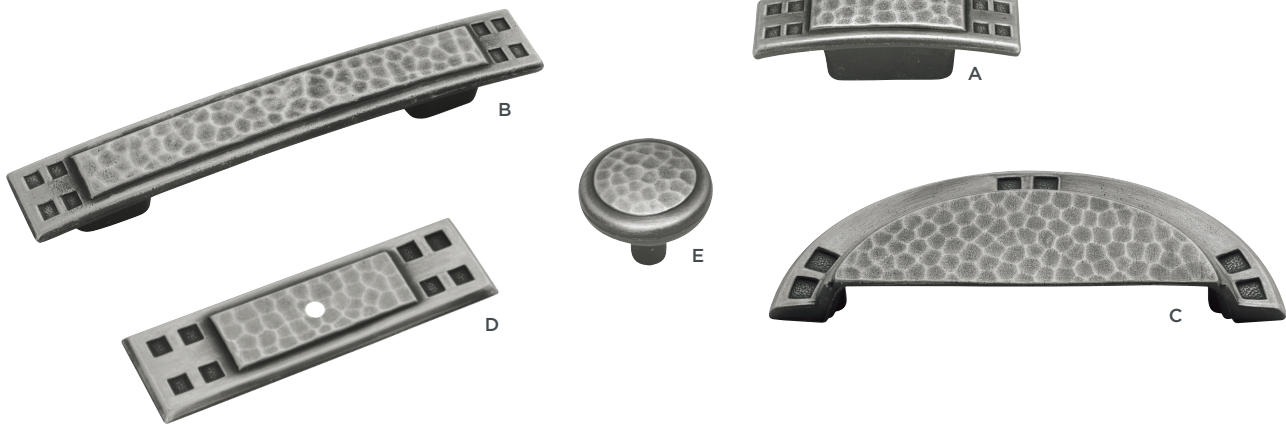

## WINDOVER ANTIQUE 54% Scale

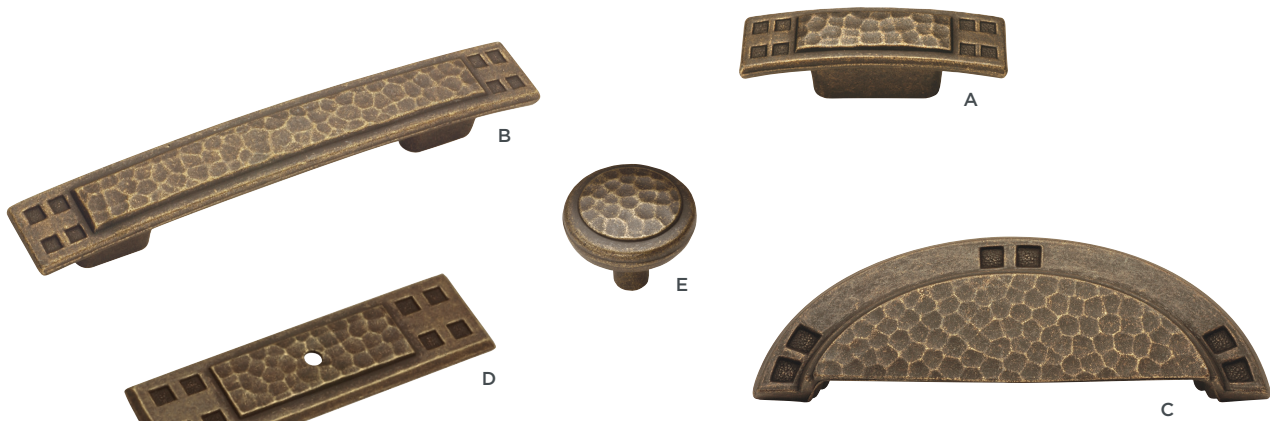

# CHARLESTON BLACKSMITH

PRODUCT SPECIFICATIONS							PART NUMBER	FINISH CODE	
C/C	L	W	P	D	B	Rustic Iron		Black Iron	
<b>A</b>	-	-	-	1"	1-1/4"	3/8"	PA1312-	RI	BI
<b>B</b>	-	-	-	1"	1-1/2"	5/8"	PA1311-	RI	BI
<b>C</b>	3"	3-3/4"	5/8"	1-1/8"	-	-	PA1321-	RI	BI
<b>D</b>	3"	4-3/8"	1-7/8"	1"	-	-	PA1322-	RI	BI
<b>E</b>	3"	4-1/2"	1/2"	1-1/4"	-	-	PA1323-	RI	BI

Record the "Part Number" including the hyphen followed by the "Finish Code." Example: HH075422-VB

## RUSTIC IRON 54% Scale



## BLACK IRON 54% Scale



# CRAFTSMAN

PRODUCT SPECIFICATIONS							PART NUMBER	FINISH CODE			
C/C	L	W	P	D	B	Chrome		Windover Antique	Oil-Rubbed Bronze Highlighted	Black Iron	
A	-	1-1/4"	1-1/4"	1-1/8"	-	1/2" SQ.	P2172-	CH	WOA	OBH	BI
B	-	-	-	1-1/8"	1-1/4"	1/2"	P2170-	CH	WOA	OBH	BI
C	96mm	5-5/16"	1-1/8"	1-1/2"	-	-	P2173-	CH	WOA	OBH	BI
D	96mm	4-7/16"	1-9/16"	1"	-	-	P2174-	CH	WOA	OBH	BI
E	3"	4-3/8"	7/8"	1-3/8"	-	-	P2171-	CH	WOA	OBH	BI

Record the "Part Number" including the hyphen followed by the "Finish Code." Example: HH075422-VB

## CHROME

54% Scale



A



B



D



C



E

## WINDOVER ANTIQUE

54% Scale



A



B



D



C



E

---

OIL-RUBBED BRONZE HIGHLIGHTED

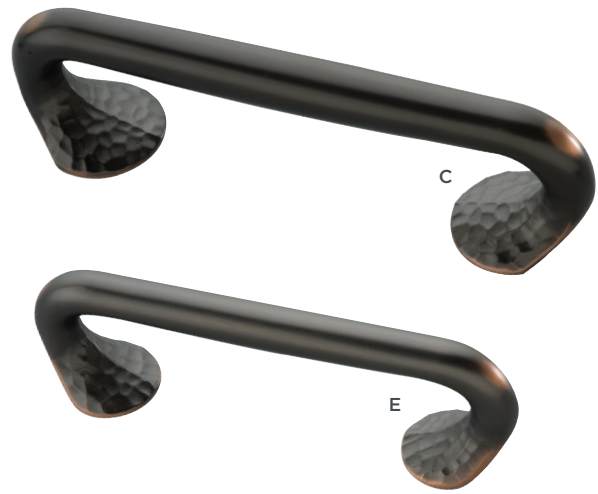
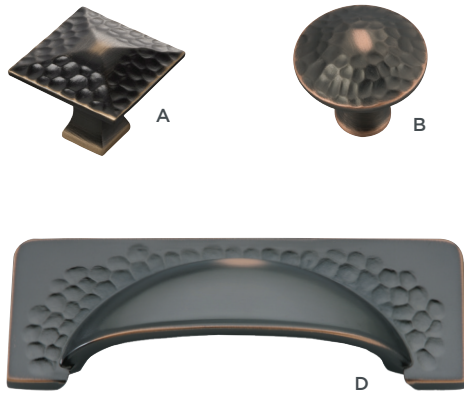

---

BLACK IRON  
54% Scale

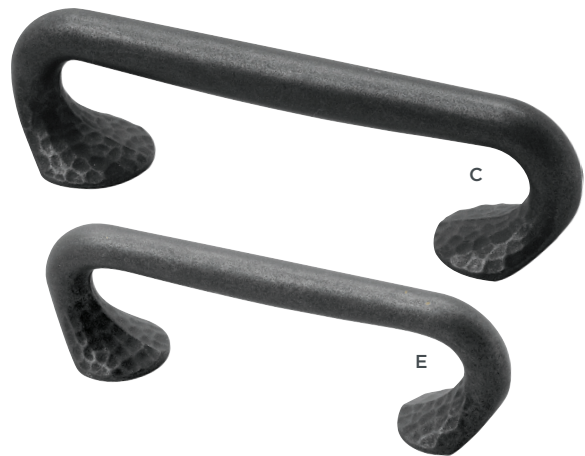
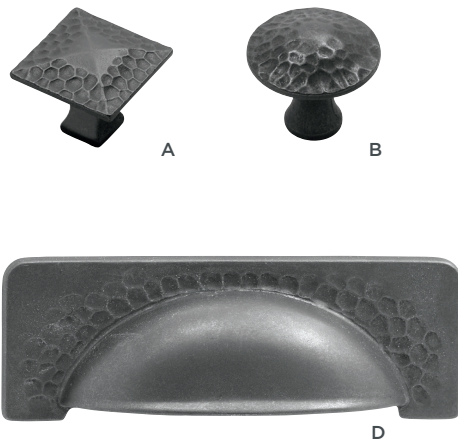

---

MATCHING HOOKS AVAILABLE

See page 190 for specs and finish options. Not to scale.



# MANCHESTER

PRODUCT SPECIFICATIONS							PART NUMBER	FINISH CODE		
C/C	L	W	P	D	B		Vibra Pewter	Biscayne Antique	Rustic Iron	
<b>A</b>	-	-	-	1"	1-3/8"	3/4"	P2011-	VP	BYA	RI
<b>B</b>	-	-	-	1-1/8"	1-1/4"	5/8"	PA1218-	VP	BYA	RI
<b>C</b>	-	2-1/8"	1-1/2"	3/4"	-	-	P2014-	VP	-	RI
<b>D</b>	2-3/4"	3-1/4"	1-3/8"	3/4"	-	-	PA1021-	VP	BYA	RI
<b>E</b>	96mm	4-1/8"	5/8"	1-1/4"	-	-	P2023-	VP	BYA	RI
<b>F</b>	3"	4-9/16"	1-1/4"	1"	-	-	PA0621-	VP	-	-
<b>G</b>	-	-	-	7/8"	1-1/4"	1/2"	P7351-	-	BYA	RI

Record the "Part Number" including the hyphen followed by the "Finish Code." Example: HH075422-VB





VIBRA PEWTER  
54% Scale

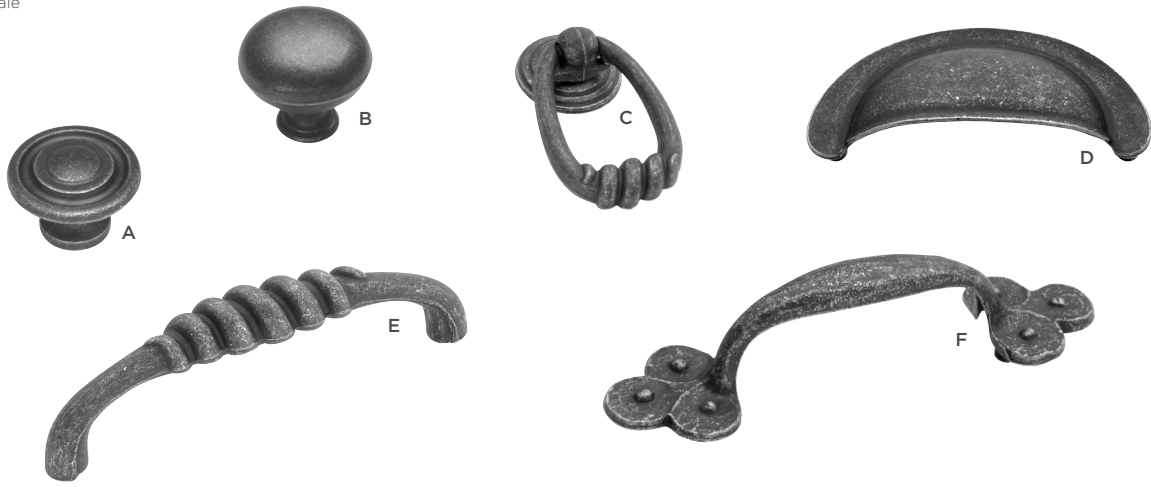

BISCAYNE ANTIQUE  
54% Scale

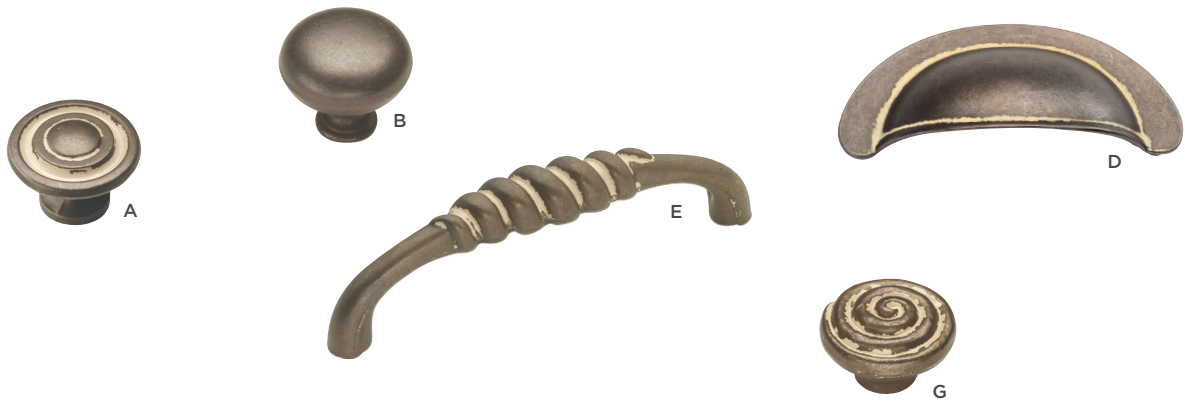

RUSTIC IRON  
54% Scale

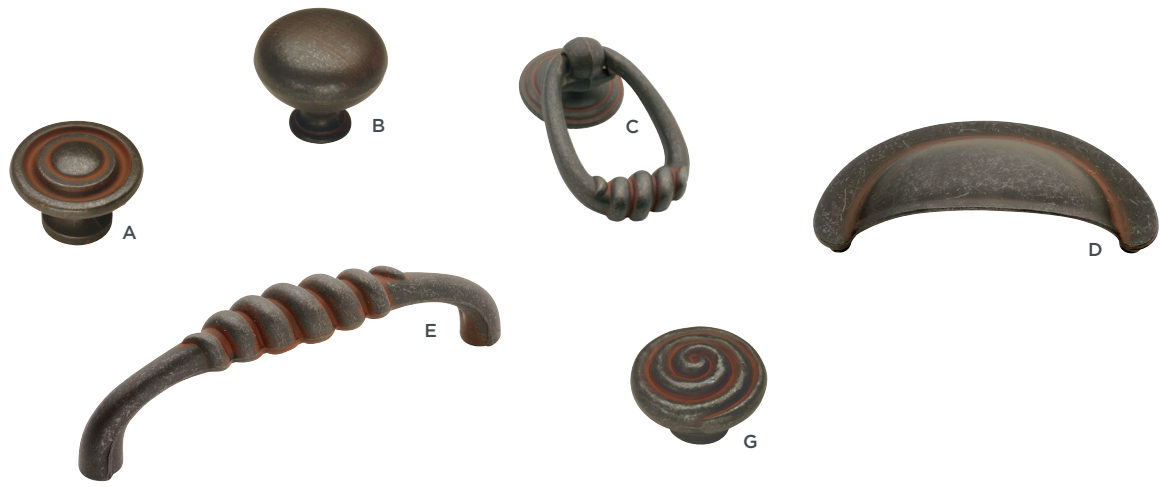

# MOUNTAIN LODGE

PRODUCT SPECIFICATIONS						PART NUMBER	FINISH CODE			
C/C	L	W	P	D	B		Windover Antique	Dark Antique Copper	Black Iron	
A	-	-	-	1-1/16"	1-3/8"	3/4"	P3061-	WOA	DAC	BI
B	-	-	-	1-1/4"	1-3/8"	3/8"	P3063-	WOA	-	BI
C	-	1-1/4"	1-1/4"	1-1/4"	-	7/16"	P3062-	WOA	DAC	BI
D	3"	5-5/8"	1"	1-1/4"	-	-	P3060-	WOA	DAC	BI
E	96mm	4-1/4"	1-7/8"	1-1/8"	-	-	P3064-	WOA	DAC	BI

Record the "Part Number" including the hyphen followed by the "Finish Code." Example: HH075422-VB

## WINDOVER ANTIQUE

54% Scale



## DARK ANTIQUE COPPER

54% Scale



## BLACK IRON

54% Scale





# PIPELINE

PRODUCT SPECIFICATIONS						PART NUMBER	FINISH CODE		
C/C	L	W	P	D	B		Black Nickel Vibed	Vintage Bronze	
<b>A</b>	-	-	-	1-1/8"	1-1/4"	15/16"	HH075028-	BNV	VB
<b>B</b>	3"	3-11/16"	11/16"	1-3/8"	-	-	HH076013-	BNV	VB
<b>C</b>	96mm	4-1/2"	11/16"	1-3/8"	-	-	HH076011-	BNV	VB
<b>D</b>	128mm	5-3/4"	11/16"	1-3/8"	-	-	HH076012-	BNV	VB
<b>E</b>	160mm	7"	11/16"	1-3/8"	-	-	HH075010-	BNV	VB

Record the "Part Number" including the hyphen followed by the "Finish Code." Example: HH075422-VB

## BLACK NICKEL VIBED 54% Scale



## VINTAGE BRONZE 54% Scale





---

MATCHING HOOKS AVAILABLE

See page 191 for specs and finish options. Not to scale.



# REFINED RUSTIC

	PRODUCT SPECIFICATIONS						FINISH CODE	FINISH CODE	
	C/C	L	W	P	D	B		Rustic Iron	Black Iron
<b>A</b>	-	-	-	1-1/4"	1-1/4"	3/8"	P3002-	RI	BI
<b>B</b>	-	-	-	1-3/8"	1-1/2"	3/8"	P3003-	RI	BI
<b>C</b>	3"	4-3/4"	13/16"	1-1/4"	-	-	P3001-	RI	BI
<b>D</b>	96mm	5-9/16"	13/16"	1-1/4"	-	-	P3000-	RI	BI
<b>E</b>	128mm	6-15/16"	7/8"	1-3/16"	-	-	P2998-	RI	BI
<b>F</b>	160mm	8-3/4"	1"	1-5/16"	-	-	P2997-	RI	BI
<b>G</b>	192mm	10-1/2"	1"	1-3/8"	-	-	P2996-	RI	BI
<b>H</b>	224mm	12-3/8"	1"	1-7/16"	-	-	P2995-	RI	BI
<b>I</b>	12"	16-13/16"	1-1/16"	1-7/16"	-	-	P2994-	RI	BI
<b>J</b>	3" & 96mm	5-9/16"	1-5/16"	15/16"	-	-	P3004-	RI	BI
<b>K</b>	18" AP*	21"	1-3/4"	2-1/4"	-	-	P2999-	RI	BI
<b>L</b>	12" AP*	15"	1-1/2"	2-1/16"	-	-	P3005-	RI	BI
<b>M</b>	8" AP*	11-1/8"	1-1/2"	2"	-	-	P3006-	RI	BI

Record the "Part Number" including the hyphen followed by the "Finish Code." Example: HH075422-VB  
 AP\* = Appliance Pull



RUSTIC IRON  
32% Scale

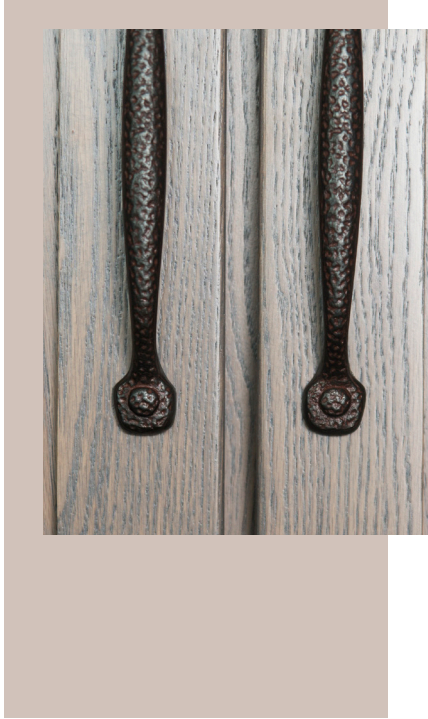

# REFINED RUSTIC

PRODUCT SPECIFICATIONS							FINISH CODE	FINISH CODE	
C/C	L	W	P	D	B		Rustic Iron	Black Iron	
<b>A</b>	-	-	-	1-1/4"	1-1/4"	3/8"	P3002-	RI	BI
<b>B</b>	-	-	-	1-3/8"	1-1/2"	3/8"	P3003-	RI	BI
<b>C</b>	3"	4-3/4"	13/16"	1-1/4"	-	-	P3001-	RI	BI
<b>D</b>	96mm	5-9/16"	13/16"	1-1/4"	-	-	P3000-	RI	BI
<b>E</b>	128mm	6-15/16"	7/8"	1-3/16"	-	-	P2998-	RI	BI
<b>F</b>	160mm	8-3/4"	1"	1-5/16"	-	-	P2997-	RI	BI
<b>G</b>	192mm	10-1/2"	1"	1-3/8"	-	-	P2996-	RI	BI
<b>H</b>	224mm	12-3/8"	1"	1-7/16"	-	-	P2995-	RI	BI
<b>I</b>	12"	16-13/16"	1-1/16"	1-7/16"	-	-	P2994-	RI	BI
<b>J</b>	3" & 96mm	5-9/16"	1-5/16"	15/16"	-	-	P3004-	RI	BI
<b>K</b>	18" AP*	21"	1-3/4"	2-1/4"	-	-	P2999-	RI	BI
<b>L</b>	12" AP*	15"	1-1/2"	2-1/16"	-	-	P3005-	RI	BI
<b>M</b>	8" AP*	11-1/8"	1-1/2"	2"	-	-	P3006-	RI	BI

Record the "Part Number" including the hyphen followed by the "Finish Code." Example: HH075422-VB  
 AP\* = Appliance Pull





BLACK IRON  
32% Scale

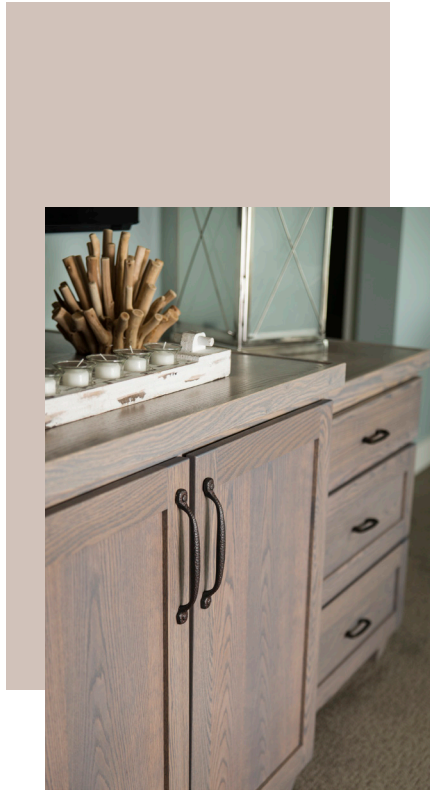

---

# RUSTIC SELECTIONS

A selection of craftsmanship with character, coarse in texture, keeping true to the natural state of materials.

PRODUCT SPECIFICATIONS						PART NUMBER	FINISH CODE	
C/C	L	W	P	D	B		Black Nickel Vibed	
<b>A</b>	3"	3-3/8"	3/8"	1-1/8"	-	-	P3444-	BNW
<b>B</b>	-	1-1/4"	1-1/4"	15/16"	-	5/16"	P3443-	BNW

Record the "Part Number" including the hyphen followed by the "Finish Code." Example: HH075422-VB

## BLACK NICKEL VIBED

54% Scale

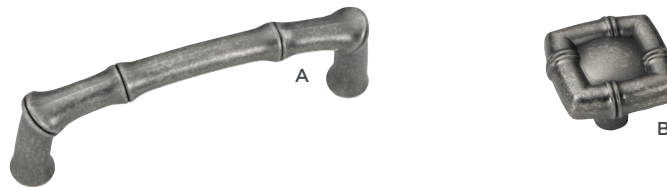

# BEDROCK

PRODUCT SPECIFICATIONS						PART NUMBER	FINISH CODE	
C/C	L	W	P	D	B		Dark Antique Copper	
<b>A</b>	3"	3-1/2"	3/8"	15/16"	-	-	P3565-	DAC
<b>B</b>	-	-	-	15/16"	1-1/4"	5/16"	P3564-	DAC

Record the "Part Number" including the hyphen followed by the "Finish Code." Example: HH075422-VB

## DARK ANTIQUE COPPER

54% Scale

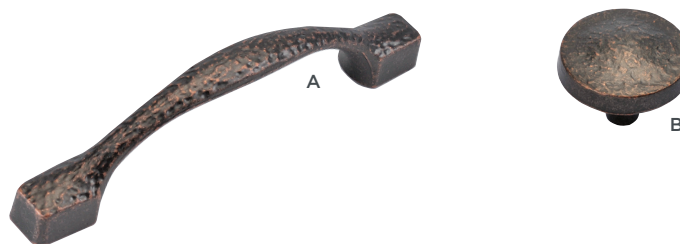

# CARBONITE

PRODUCT SPECIFICATIONS							PART NUMBER	FINISH CODE
C/C	L	W	P	D	B		Black Iron	
A	-	1-1/4"	1-1/4"	1-1/8"	-	1/2"	P3670-	BI
B	-	1-7/8"	1"	1-3/8"	-	-	P3671-	BI
C	-	-	-	1"	1-1/2"	1/2"	P2182-	BI
D	4"	5-1/8"	7/8"	1-3/8"	-	-	P3672-	BI

Record the "Part Number" including the hyphen followed by the "Finish Code." Example: HH075422-VB

BLACK IRON  
54% Scale

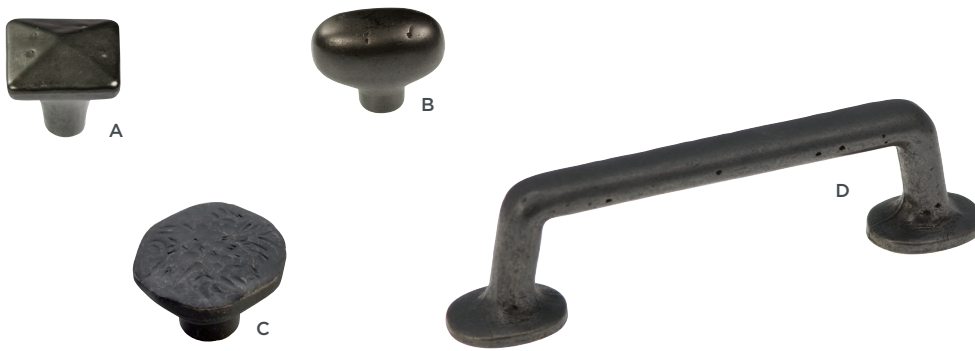

# CLOVER CREEK

PRODUCT SPECIFICATIONS							PART NUMBER	FINISH CODE
C/C	L	W	P	D	B		Dark Antique Copper	
A	3"	4-7/16"	11/16"	15/16"	-	-	P3563-	DAC
B	-	-	-	1-1/16"	1-1/4"	3/8"	P3562-	DAC

Record the "Part Number" including the hyphen followed by the "Finish Code." Example: HH075422-VB

DARK ANTIQUE COPPER  
54% Scale



# NATURAL WOODCRAFT

PRODUCT SPECIFICATIONS							PART NUMBER	FINISH CODE	
C/C	L	W	P	D	B	Quantity		Unfinished Wood	
<b>A</b>	-	-	-	1-1/8"	1-1/4"	1"	Sold in pairs	P685-	UW
<b>B</b>	-	-	-	15/16"	1-1/4"	3/4"	Sold in pairs	P180-	UW
<b>C</b>	-	-	-	1"	2"	1"	Sold in pairs	P186-	UW
<b>D</b>	-	-	-	7/8"	1-1/4"	3/4"	Sold in pairs	P184-	UW
<b>E</b>	-	-	-	7/8"	1-1/2"	7/8"	Sold in pairs	P185-	UW
<b>F</b>	-	-	-	3/4"	1"	7/8"	Sold in pairs	P183-	UW
<b>G</b>	-	-	-	1-1/4"	1-1/4"	1"	Sold in pairs	P684-	UW
<b>H</b>	3"	3-5/8"	11/16"	1-1/4"	-	-	Sold singularly	P673-	UW
<b>I</b>	3-1/2"	4-1/8"	11/16"	1-1/4"	-	-	Sold singularly	P674-	UW
<b>J</b>	96mm	4-3/8"	7/8"	7/8"	-	-	Sold singularly	P687-	UW
<b>K</b>	96mm	4-5/8"	1-7/8"	7/8"	-	-	Sold singularly	P676-	UW

Record the "Part Number" including the hyphen followed by the "Finish Code." Example: HH075422-VB

## UNFINISHED WOOD

54% Scale



# NATURAL ACCENTS

PRODUCT SPECIFICATIONS							PART NUMBER	FINISH CODE
C/C	L	W	P	D	B		Vibra Pewter	
A	3"	5"	1-3/4"	3/4"	-	-	P7304-	VP
B	3"	5-3/8"	7/8"	1"	-	-	P7303-	VP
C	-	-	-	1-1/4"	1-1/4"	3/8"	P7301-	VP
D	96mm	5-3/4"	1-3/8"	1-1/8"	-	-	P7302-	VP
E	-	1-1/2"	1-1/2"	1-1/8"	-	3/8"	PA0114-	VP
F	-	1-7/16"	1-3/8"	1"	-	3/8"	PA0112-	VP
G	-	2-3/16"	1-9/16"	15/16"	-	3/8"	PA1512-	VP
H	-	1-3/8"	1-1/2"	1"	-	3/8"	PA0115-	VP
I	-	1-1/2"	1-1/2"	1-1/8"	-	3/8"	PA0111-	VP
J	-	1-9/16"	1-15/16"	7/8"	-	3/8"	PA1513-	VP
K	3"	3-11/16"	13/16"	1-1/16"	-	-	PA0122-	VP
L	3" & 96mm	5"	1"	1-1/8"	-	-	PA0121-	VP

Record the "Part Number" including the hyphen followed by the "Finish Code." Example: HH075422-VB

## VIBRA PEWTER 54% Scale

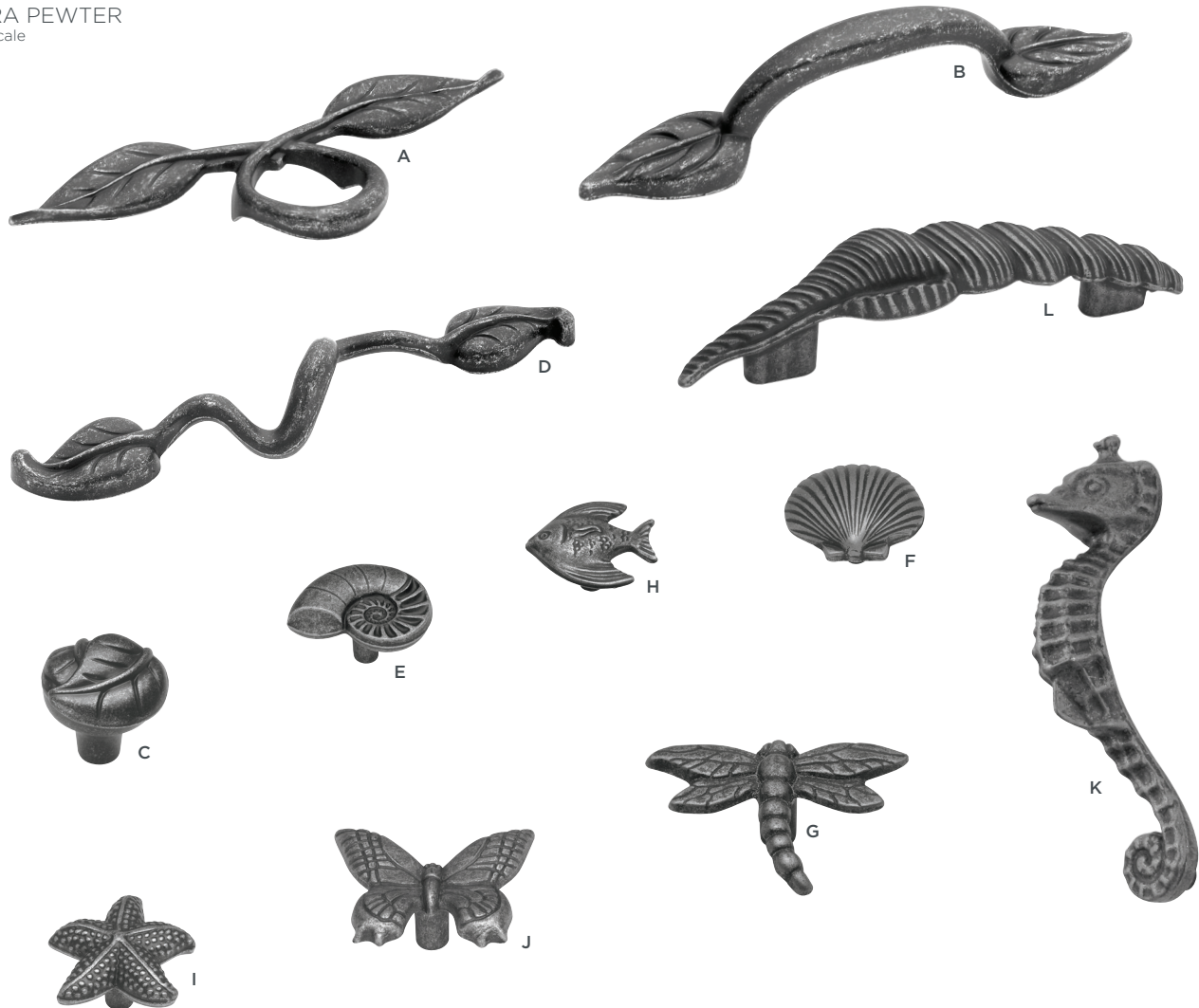

# OLD MISSION

PRODUCT SPECIFICATIONS				PART NUMBER	FINISH CODE	
C/C	L	W	P		Black Mist Antique	
<b>A</b>	1-1/8"	2-3/4"	1-3/4"	1/2"	PA0711-	BMA
<b>B</b>	1-1/2"	3-3/4"	2"	5/8"	PA0721-	BMA
<b>C</b>	1-1/4"	3-3/4"	1-5/8"	1/2"	PA0712-	BMA

Record the "Part Number" including the hyphen followed by the "Finish Code." Example: HH075422-VB

## BLACK MIST ANTIQUE

54% Scale







	PRODUCT SPECIFICATIONS						PART NUMBER	FINISH CODE		
	C/C	L	W	P	D	B		Antique Brass	Antique Copper	Colonial Black
<b>A</b>	2-1/2"	3-7/16"	1-1/2"	1/4"	-	-	P148-	AB	-	-
<b>B</b>	-	-	-	3/4"	1-1/8"	5/16"	P146-	AB	-	-
<b>C</b>	3-1/4"	5"	1-1/8"	13/16"	-	-	P145-	AB	-	-
<b>D</b>	2-1/2"	3-7/16"	1-1/2"	1/4"	-	-	P106-	-	AC	CB
<b>E</b>	-	-	-	5/8"	1-1/16"	3/8"	P102-	-	AC	CB
<b>F</b>	3-1/4"	5"	1"	13/16"	-	-	P101-	-	AC	CB

Record the "Part Number" including the hyphen followed by the "Finish Code." Example: HH075422-VB

## ANTIQUE BRASS

54% Scale

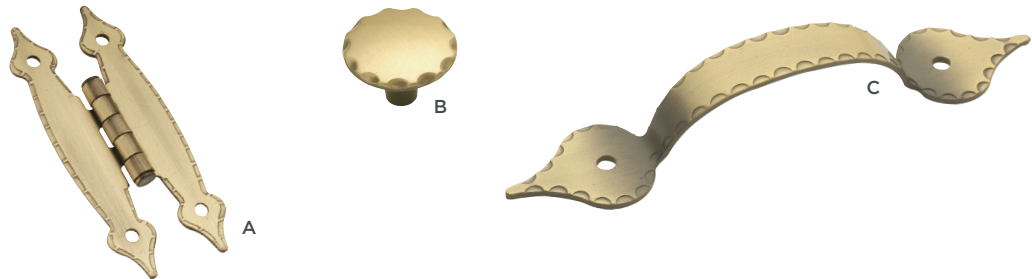

## ANTIQUE COPPER

54% Scale

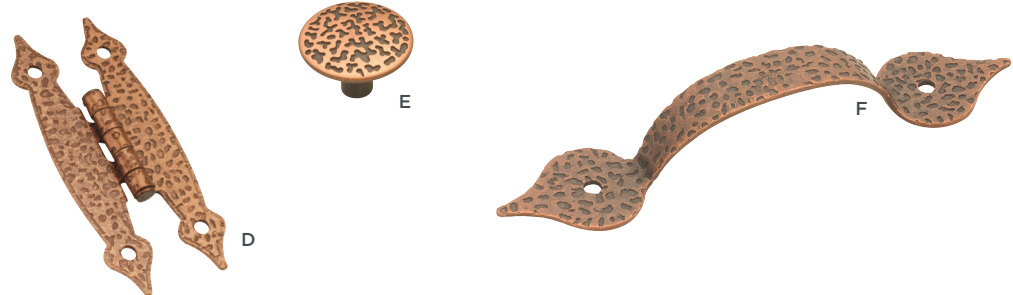

## COLONIAL BLACK

54% Scale

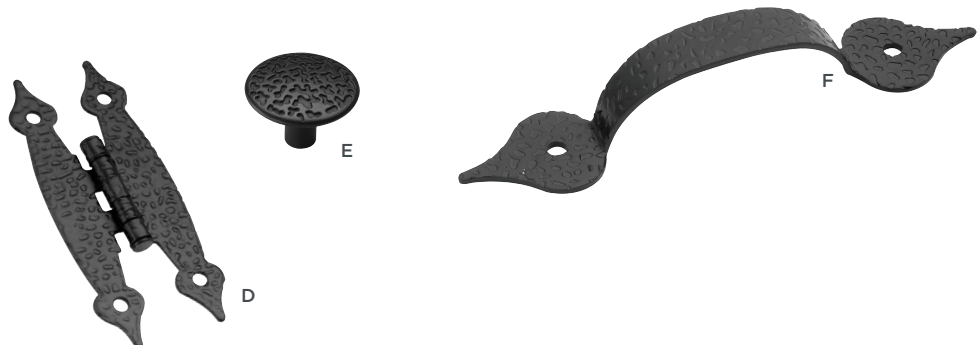

---

# APPLIANCE PULLS

Elevate the impact of your appliances with enlarged and lengthened pull designs for a more complete look.



# AMERICAN DINER

PRODUCT SPECIFICATIONS				PART NUMBER	FINISH CODE		
C/C	L	W	P		Satin Nickel	Stainless Steel	
<b>A</b>	8"	9-5/8"	1-1/4"	1-1/2"	P2146-	SN	SS
<b>B</b>	18"	20-1/8"	1-1/2"	1-7/8"	P2148-	SN	SS
<b>C</b>	12"	13-5/8"	1-1/4"	1-1/2"	P2147-	SN	SS

Record the "Part Number" including the hyphen followed by the "Finish Code." Example: HH075422-VB

## SATIN NICKEL

32% Scale



## STAINLESS STEEL

32% Scale



	PRODUCT SPECIFICATIONS				PART NUMBER	FINISH CODE	
	C/C	L	W	P		Satin Nickel	Stainless Steel
<b>A</b>	8"	8-7/8"	7/8"	2-3/8"	K60-	15	SS
<b>B</b>	24"	24-7/8"	7/8"	2-3/8"	K63-	15	SS
<b>C</b>	18"	18-7/8"	7/8"	2-3/8"	K62-	15	SS
<b>D</b>	12"	12-7/8"	7/8"	2-3/8"	K61-	15	SS

Record the "Part Number" including the hyphen followed by the "Finish Code." Example: HH075422-VB

**SATIN NICKEL**  
32% Scale



# COTTAGE

PRODUCT SPECIFICATIONS				PART NUMBER	FINISH CODE		
C/C	L	W	P		Satin Nickel	Stainless Steel	
<b>A</b>	8"	8-7/8"	7/8"	2-3/8"	K60-	15	SS
<b>B</b>	24"	24-7/8"	7/8"	2-3/8"	K63-	15	SS
<b>C</b>	18"	18-7/8"	7/8"	2-3/8"	K62-	15	SS
<b>D</b>	12"	12-7/8"	7/8"	2-3/8"	K61-	15	SS

Record the "Part Number" including the hyphen followed by the "Finish Code." Example: HH075422-VB

STAINLESS STEEL  
32% Scale



APPLIANCE PULLS

# EURO-CONTEMPORARY

PRODUCT SPECIFICATIONS					PART NUMBER	FINISH CODE
C/C	L	W	P			Satin Nickel
<b>A</b>	12"	17-1/2"	1-1/16"	1-1/8"	P2167-	SN
<b>B</b>	18"	23-7/8"	1-1/8"	1-3/8"	P2168-	SN
<b>C</b>	8"	13"	7/8"	1-1/8"	P2166-	SN

Record the "Part Number" including the hyphen followed by the "Finish Code." Example: HH075422-VB



SATIN NICKEL  
32% Scale

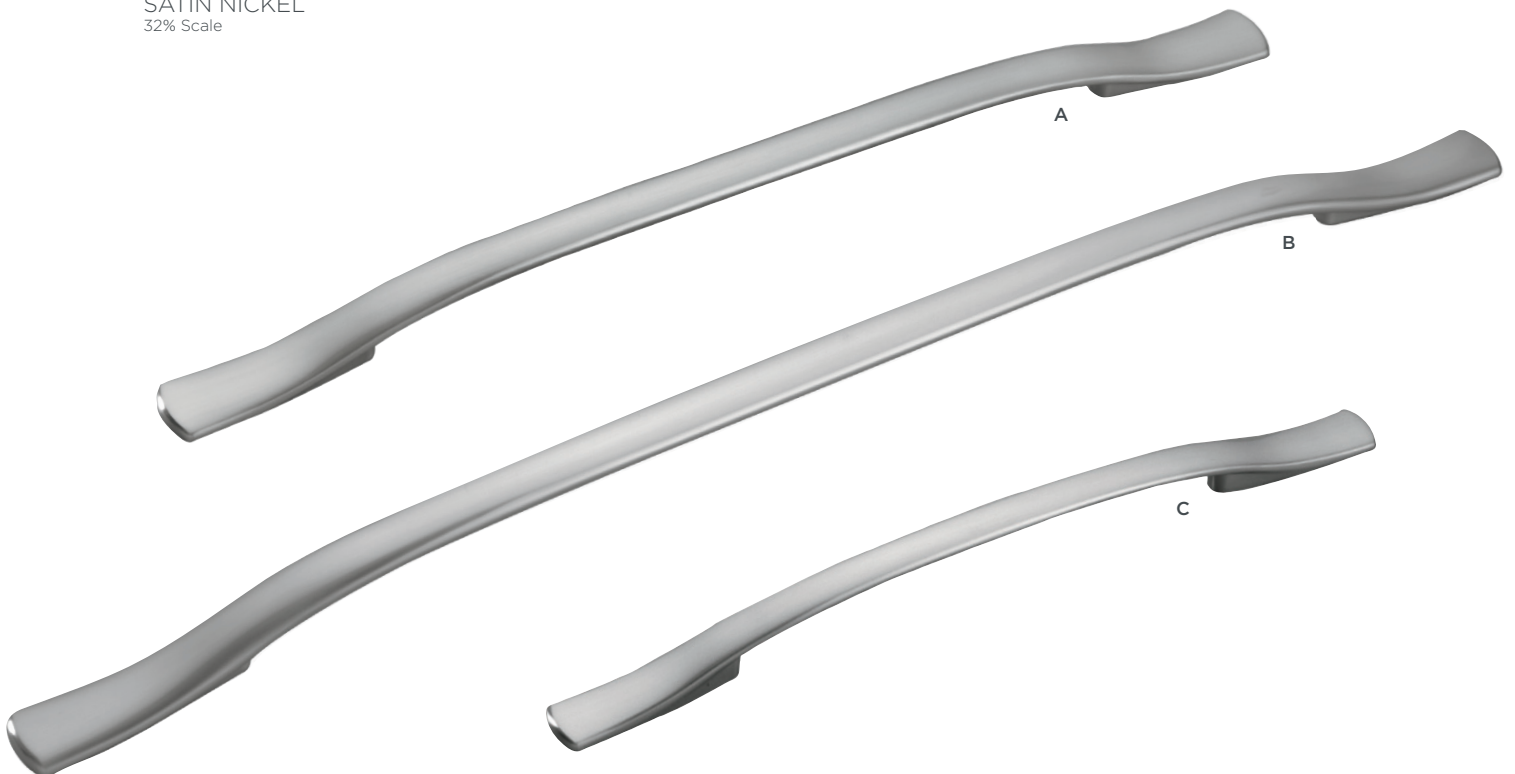





# REFINED RUSTIC

PRODUCT SPECIFICATIONS				PART NUMBER	FINISH CODE		
C/C	L	W	P		Black Iron	Rustic Iron	
<b>A</b>	8"	11-1/8"	1-1/2"	2"	P3006-	BI	RI
<b>B</b>	18"	21"	1-3/4"	2-1/4"	P2999-	BI	RI
<b>C</b>	12"	15"	1-1/2"	2-1/16"	P3005-	BI	RI

Record the "Part Number" including the hyphen followed by the "Finish Code." Example: HH075422-VB

**BLACK IRON**  
32% Scale



**RUSTIC IRON**  
32% Scale



# STUDIO

PRODUCT SPECIFICATIONS					PART NUMBER	FINISH CODE				
C/C	L	W	P			Stainless Steel	Veneti Bronze	Polished Nickel	Satin Nickel	Oil-Rubbed Bronze Highlighted
<b>A</b>	8"	8-5/8"	1-3/8"	1-5/8"	P3017-	-	-	14	SN	OBH
<b>B</b>	13"	14-5/8"	1-5/8"	2"	P3016-	-	-	14	SN	OBH
<b>C</b>	18"	19-5/8"	1-5/8"	2"	P2279-	SS	VBZ	14	SN	OBH

Record the "Part Number" including the hyphen followed by the "Finish Code." Example: HH075422-VB

## POLISHED NICKEL 32% Scale

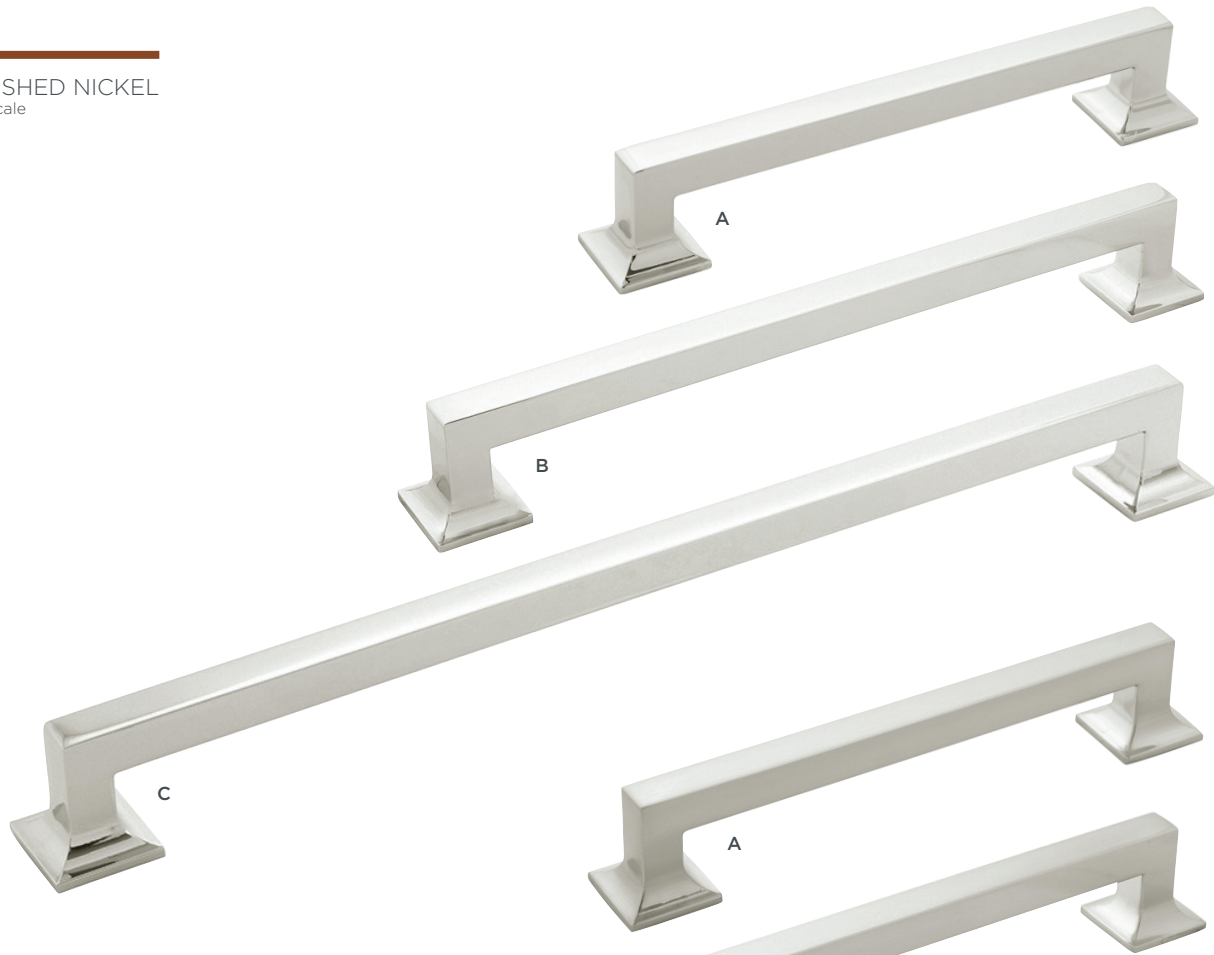

## SATIN NICKEL 32% Scale

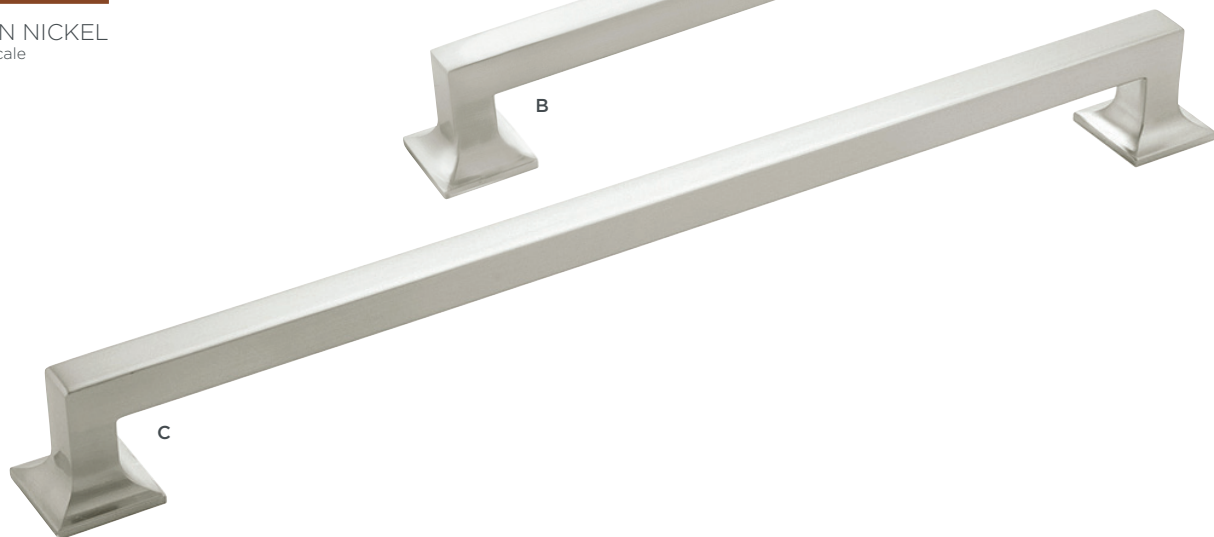

STAINLESS STEEL  
32% Scale



VENETI BRONZE  
32% Scale

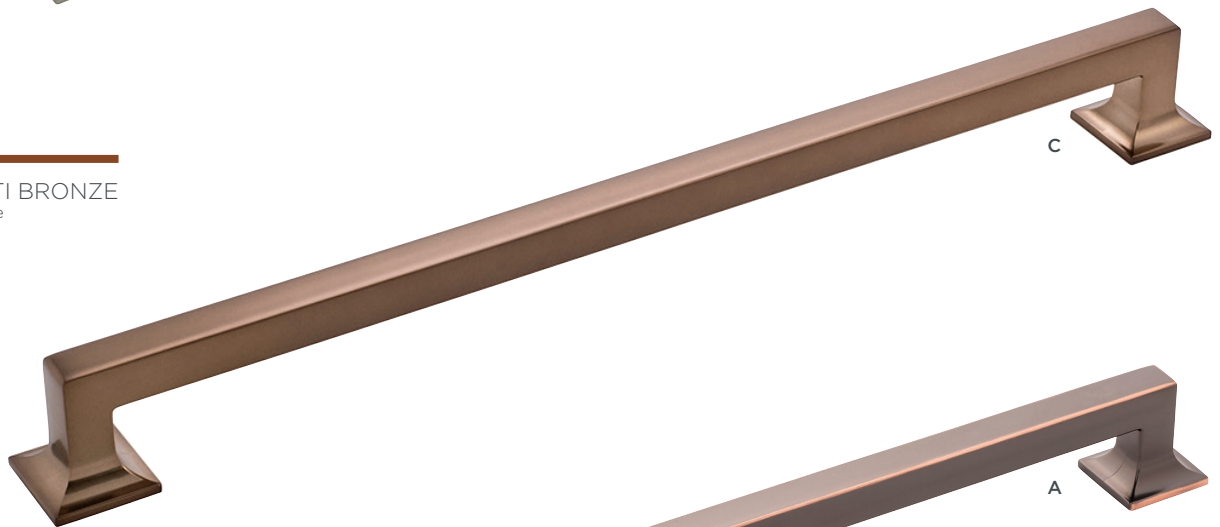

OIL-RUBBED BRONZE HIGHLIGHTED  
32% Scale



# WILLIAMSBURG

PRODUCT SPECIFICATIONS					PART NUMBER	FINISH CODE		
C/C	L	W	P	Stainless Steel		Black Nickel Vined	Oil-Rubbed Bronze Highlighted	
<b>A</b>	8"	8-7/8"	1-3/8"	2-1/2"	K48-	SS	BNV	OBH
<b>B</b>	12"	12-7/8"	1-3/8"	2-1/2"	K49-	SS	BNV	OBH
<b>C</b>	18"	18-7/8"	1-3/8"	2-1/2"	K50-	SS	BNV	OBH
<b>D</b>	24"	24-7/8"	1-5/16"	2-7/16"	K51-	SS	BNV	OBH

Record the "Part Number" including the hyphen followed by the "Finish Code." Example: HH075422-VB

## STAINLESS STEEL

32% Scale

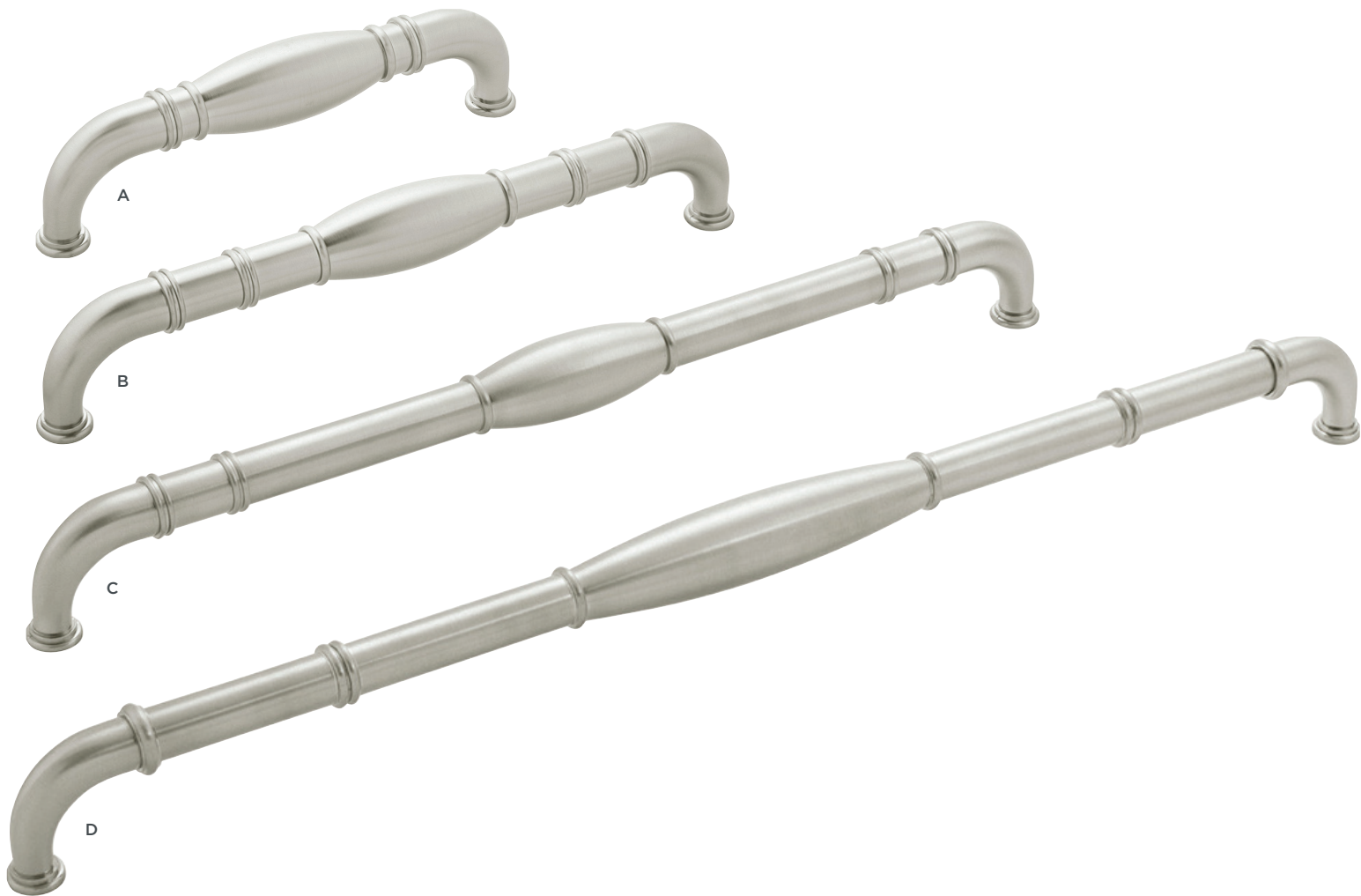

APPLIANCE PULLS



# WILLIAMSBURG

PRODUCT SPECIFICATIONS				PART NUMBER	FINISH CODE			
C/C	L	W	P		Stainless Steel	Black Nickel Viced	Oil-Rubbed Bronze Highlighted	
<b>A</b>	8"	8-7/8"	1-3/8"	2-1/2"	K48-	SS	BNV	OBH
<b>B</b>	12"	12-7/8"	1-3/8"	2-1/2"	K49-	SS	BNV	OBH
<b>C</b>	18"	18-7/8"	1-3/8"	2-1/2"	K50-	SS	BNV	OBH
<b>D</b>	24"	24-7/8"	1-5/16"	2-7/16"	K51-	SS	BNV	OBH

Record the "Part Number" including the hyphen followed by the "Finish Code." Example: HH075422-VB

BLACK NICKEL VICED  
32% Scale



APPLIANCE PULLS



OIL-RUBBED BRONZE HIGHLIGHTED  
32% Scale



# ZEPHYR

PRODUCT SPECIFICATIONS					PART NUMBER	FINISH CODE		
C/C	L	W	P			Satin Nickel	Stainless Steel	Oil-Rubbed Bronze Highlighted
<b>A</b>	18"	19-3/8"	1-1/2"	2"	P3008-	SN	SS	OBH
<b>B</b>	13"	14-1/2"	1-1/2"	1-7/8"	P2289-	SN	SS	OBH
<b>C</b>	8"	9-1/8"	1-1/8"	1-1/2"	P2288-	SN	SS	OBH

Record the "Part Number" including the hyphen followed by the "Finish Code." Example: HH075422-VB

**SATIN NICKEL**  
32% Scale



**STAINLESS STEEL**  
32% Scale





OIL-RUBBED BRONZE HIGHLIGHTED

32% Scale



---

# HOOKS

A selection of hook styles for organization.



# AMERICAN DINER SIGNATURE HOOKS

PRODUCT SPECIFICATIONS				PART NUMBER	FINISH	
C/C	L	W	P			
<b>A</b>	7/8"	4-1/2"	1-7/16"	2-7/8"	P2145-CH	Chrome
<b>B</b>	7/8"	4-1/2"	1-7/16"	2-7/8"	P2145-SN	Satin Nickel

Record the "Part Number" including the hyphen followed by the "Finish Code."

## VARIOUS FINISHES

Not to Scale



A



B



@mycreativedays

# BUNGALOW SIGNATURE HOOKS

	PRODUCT SPECIFICATIONS				PART NUMBER	FINISH
	C/C	L	W	P		
<b>A</b>	1-1/2"	5"	2"	4-1/16"	P2155-14	Polished Nickel
<b>B</b>	1-1/2"	5"	2"	4-1/16"	P2155-SN	Satin Nickel
<b>C</b>	1-1/2"	5"	2"	4-1/16"	P2155-WOA	Windover Antique
<b>D</b>	1-1/2"	5"	2"	4-1/16"	P2155-OBH	Oil-Rubbed Bronze Highlighted
<b>E</b>	1-1/2"	5"	2"	4-1/16"	P2155-10B	Oil-Rubbed Bronze

Record the "Part Number" including the hyphen followed by the "Finish Code."

## VARIOUS FINISHES

Not to Scale



## COTTAGE SIGNATURE HOOKS

PRODUCT SPECIFICATIONS					PART NUMBER	FINISH
C/C	L	W	P			
<b>A</b>	1"	5-1/4"	1-1/2"	2-1/2"	S077194-14	Polished Nickel
<b>B</b>	1"	5-1/4"	1-1/2"	2-1/2"	S077194-CH	Chrome
<b>C</b>	1"	5-1/4"	1-1/2"	2-1/2"	S077194-SN	Satin Nickel
<b>D</b>	1"	5-1/4"	1-1/2"	2-1/2"	S077194-VB	Vintage Bronze

Record the "Part Number" including the hyphen followed by the "Finish Code."

### VARIOUS FINISHES

Not to Scale



## CRAFTSMAN SIGNATURE HOOKS

PRODUCT SPECIFICATIONS					PART NUMBER	FINISH
C/C	L	W	P			
<b>A</b>	1-3/8"	5-1/16"	2"	3-5/8"	P2175-CH	Chrome
<b>B</b>	1-3/8"	5-1/16"	2"	3-5/8"	P2175-WOA	Windover Antique
<b>C</b>	1-3/8"	5-1/16"	2"	3-5/8"	P2175-OBH	Oil-Rubbed Bronze Highlighted
<b>D</b>	1-3/8"	5-1/16"	2"	3-5/8"	P2175-BI	Black Iron

Record the "Part Number" including the hyphen followed by the "Finish Code."

### VARIOUS FINISHES

Not to Scale



## FORGE SIGNATURE HOOKS

PRODUCT SPECIFICATIONS				PART NUMBER	FINISH	
C/C	L	W	P			
<b>A</b>	1-1/2"	2-3/4"	2"	2-5/16"	S077190-CH	Chrome
<b>B</b>	1-1/2"	2-3/4"	2"	2-5/16"	S077190-SN	Satin Nickel
<b>C</b>	1-1/2"	2-3/4"	2"	2-5/16"	S077190-BGB	Brushed Golden Brass
	1-1/2"	2-3/4"	2"	2-5/16"	S077190-BI	Black Iron

Record the "Part Number" including the hyphen followed by the "Finish Code."

### VARIOUS FINISHES

Not to Scale

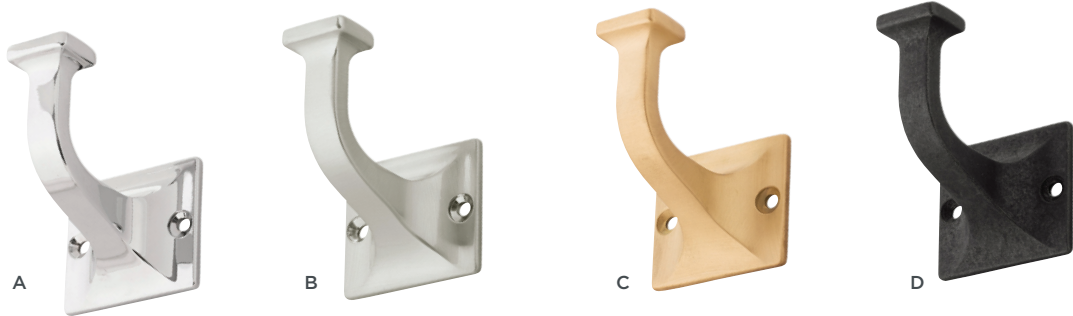

## PIPELINE SIGNATURE HOOKS

PRODUCT SPECIFICATIONS				PART NUMBER	FINISH	
C/C	L	W	P			
<b>A</b>	1-1/2"	2-1/2"	2-1/8"	2-3/8"	S077188-BNV	Black Nickel Vibed
<b>B</b>	1-1/2"	2-1/2"	2-1/8"	2-3/8"	S077188-VB	Vintage Bronze

Record the "Part Number" including the hyphen followed by the "Finish Code."

### VARIOUS FINISHES

Not to Scale



## SKYLIGHT SIGNATURE HOOKS

PRODUCT SPECIFICATIONS					PART NUMBER	FINISH
C/C	L	W	P			
<b>A</b>	1"	4-7/8"	1-1/2"	2-3/4"	S077192-14	Polished Nickel
<b>B</b>	1"	4-7/8"	1-1/2"	2-3/4"	S077192-SS	Stainless Steel
<b>C</b>	1"	4-7/8"	1-1/2"	2-3/4"	S077192-BGB	Brushed Golden Brass
<b>D</b>	1"	4-7/8"	1-1/2"	2-3/4"	S077192-VB	Vintage Bronze

Record the "Part Number" including the hyphen followed by the "Finish Code."

### VARIOUS FINISHES

Not to Scale

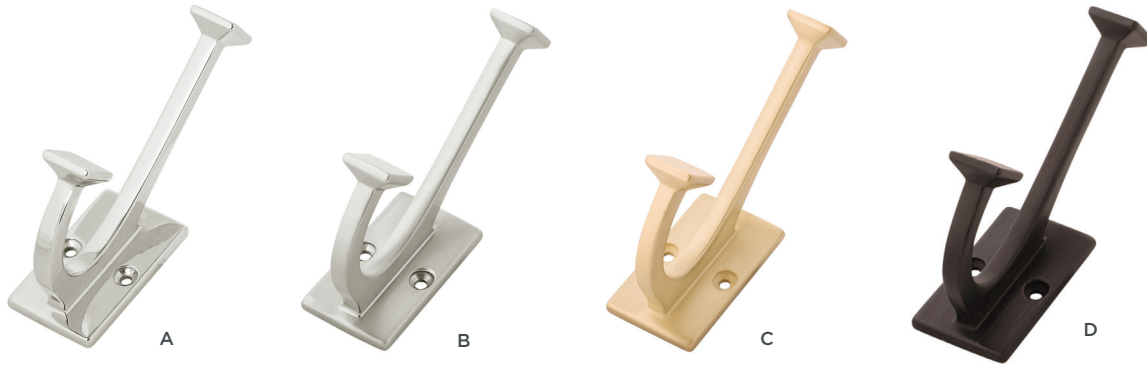

## BAR PULL SIGNATURE HOOKS

PRODUCT SPECIFICATIONS					PART NUMBER	FINISH
C/C	L	W	P			Chrome
<b>A</b>	7/8"	2-7/16"	1-1/4"	1-1/2"	P25021-CH	Chrome
<b>B</b>	7/8"	2-7/16"	1-1/4"	1-1/2"	P25021-SN	Satin Nickel
<b>C</b>	7/8"	2-7/16"	1-1/4"	1-1/2"	P25021-BGB	Brushed Golden Brass

Record the "Part Number" including the hyphen followed by the "Finish Code."

### VARIOUS FINISHES

Not to Scale





	PRODUCT SPECIFICATIONS				PART NUMBER	FINISH CODE		
	C/C	L	W	P		Chrome	Satin Nickel	Black Iron
<b>A, B</b>	3/4"	2-5/8"	1-1/8"	2-5/16"	P25024-	CH	SN	-
<b>C, D</b>	7/8"	3"	1-1/4"	2-3/4"	P25025-	CH	SN	-
<b>E, F</b>	1"	3-1/8"	1-1/2"	2-1/16"	P25020-	CH	SN	-
<b>G, H</b>	5/8"	3-1/4"	2"	1-1/4"	P25026-	CH	SN	-
<b>I, J</b>	1-1/2"	4-3/4"	2-1/4"	2-3/16"	S077189-	CH	-	BI

Record the "Part Number" including the hyphen followed by the "Finish Code." Example: P25024-CH

VARIOUS FINISHES  
Not to Scale



# HOOKS

PRODUCT SPECIFICATIONS				PART NUMBER	FINISH CODE			
C/C	L	W	P		Chrome	Satin Nickel	Brushed Golden Brass	
A, B, C	5/8"	2-11/16"	1-1/16"	2-1/2"	P25029-	CH	SN	BGB

Record the "Part Number" including the hyphen followed by the "Finish Code."

## VARIOUS FINISHES

Not to Scale



PRODUCT SPECIFICATIONS				PART NUMBER	FINISH	
C/C	L	W	P			
A	3/8"	2"	2-13/16"	1-1/16"	P27115-CH	Chrome
B	3/8"	2"	2-13/16"	1-1/16"	P27115-SC	Satin Silver Cloud
C	3/8"	2"	2-13/16"	1-1/16"	P27115-W	White
D	3/8"	2"	2-13/16"	1-1/16"	P27115-PB	Polished Brass
E	3/8"	2"	2-13/16"	1-1/16"	P27115-AB	Antique Brass
F	3/8"	2"	2-13/16"	1-1/16"	P27115-VB	Vintage Bronze
G	3/8"	2"	2-13/16"	1-1/16"	P27115-BL	Black

Record the "Part Number" including the hyphen followed by the "Finish Code."

## VARIOUS FINISHES

Not to Scale

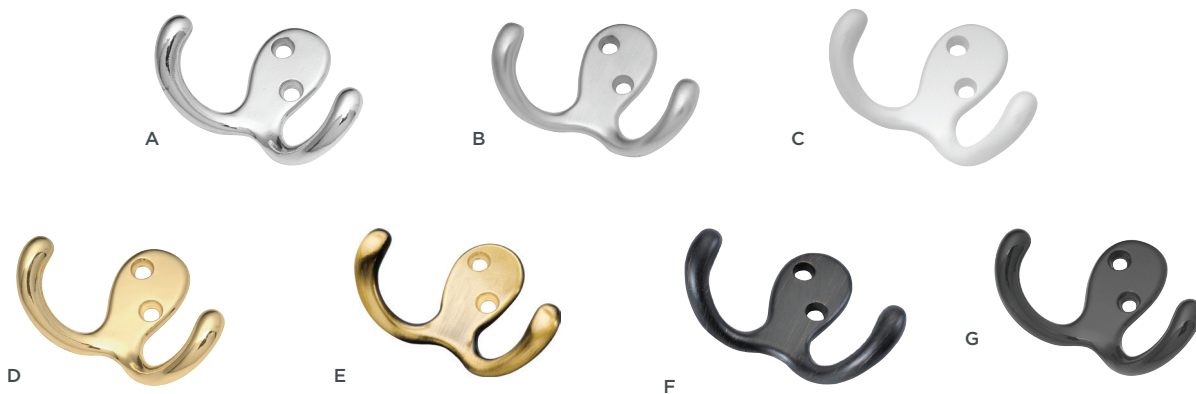

PRODUCT SPECIFICATIONS					PART NUMBER	FINISH
	C/C	L	W	P		
<b>A</b>	5/8"	3-1/4"	1-1/8"	2-7/8"	P27120-CH	Chrome
<b>B</b>	5/8"	3-1/4"	1-1/8"	2-7/8"	P27120-SC	Satin Silver Cloud
<b>C</b>	5/8"	3-1/4"	1-1/8"	2-7/8"	P27120-W	White
<b>D</b>	5/8"	3-1/4"	1-1/8"	2-7/8"	P27120-AB	Antique Brass
<b>E</b>	5/8"	3-1/4"	1-1/8"	2-7/8"	P27120-PB	Polished Brass
<b>F</b>	5/8"	3-1/4"	1-1/8"	2-7/8"	P27120-BL	Black
<b>G</b>	1/2"	2"	7/8"	1-5/8"	P27100-CH	Chrome
<b>H</b>	1/2"	2"	7/8"	1-5/8"	P27100-SC	Satin Silver Cloud
<b>I</b>	1/2"	2"	7/8"	1-5/8"	P27100-W	White
<b>J</b>	1/2"	2"	7/8"	1-5/8"	P27100-PB	Polished Brass
<b>K</b>	1/2"	2"	7/8"	1-5/8"	P27100-AB	Antique Brass
<b>L</b>	1/2"	2"	7/8"	1-5/8"	P27100-RB	Refined Bronze
<b>M</b>	1/2"	2"	7/8"	1-5/8"	P27100-VB	Vintage Bronze
<b>N</b>	1/2"	2"	7/8"	1-5/8"	P27100-BL	Black

Record the "Part Number" including the hyphen followed by the "Finish Code."

## VARIOUS FINISHES

Not to Scale



---

# FUNCTIONAL

A necessity in every home, this category includes a variety of hinges, catches, drawer slides, cabinet accessories, hand rail brackets and mounting templates.



FUNCTIONAL

# DRAWER SLIDE GENERAL GUIDELINES

## LENGTH

**Replacements:** measure your existing slide

**New Installations:** measure your drawer and cabinet

SLIDE LENGTH	FITS DRAWER LENGTHS	FITS CABINET DEPTHS
12"	10 5/8" to 12 1/2"	13" to 14 1/2"
14"	12 5/8" to 14 1/2"	15" to 16 1/2"
16"	14 5/8" to 16 1/2"	17" to 18 1/2"
18"	16 5/8" to 18 1/2"	19" to 20 1/2"
20"	18 5/8" to 20 1/2"	21" to 22 1/2"
22"	20 5/8" to 22 1/2"	23" to 24 1/2"
24"	22 5/8" to 24 1/2"	25" to 25 1/2"

## WEIGHT CAPACITY

Use center mount drawer slides or light duty side mount slides for lower weight capacity.

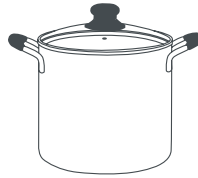

Heavy loads, such as large pots require slides with a weight capacity of 50 - 100lbs.

Side mount ball bearing slides are made for this application.

## TRAVEL

Also called extension, travel indicates how far the drawer comes out of the cabinet.

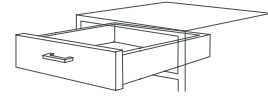

**3/4 Extension:** the drawer opens 3/4 of the drawer length

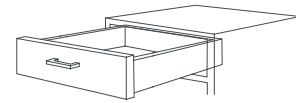

**Full Extension:** the drawer opens the full length of the slide

## DRAWER SLIDE MOUNTING TYPES

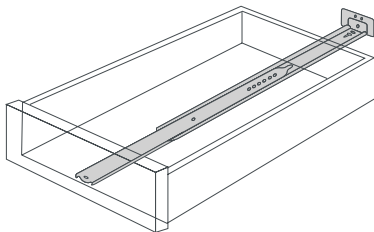

**Center Mount** drawer slides mount to the drawer's bottom face and along the center. They are concealed when the drawer is extended and are ideal for small, lightweight drawers. Center mount drawer slides are best for use on face-frame cabinets.

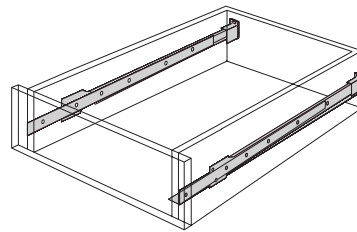

**Side Mount** drawer slides attach to the side of the drawer and the side of the inner cabinet. They are visible when the drawer is extended and tend to support more weight. Side mount drawer slides are best for use on frameless cabinets.

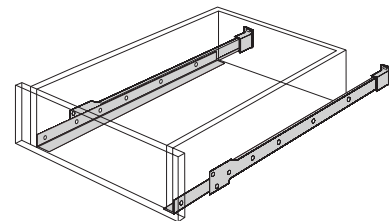

**Bottom Mount** drawer slides mount to the bottom or bottom edges of the drawer and to the sides of the drawer. Bottom mount drawer slides are a good option if you are looking for something with more weight capacity.

## TYPES OF ROLLER DRAWER SLIDES

**Ball-Bearing Rollers** offer a smooth glide for your drawer. The bearings are hardened spherical balls that greatly reduce the friction between moving parts.

**Glide Rollers** area of contact is a wheel along a line instead of a ball, which distributes the load weight over a large area.

**Self Closing** - drawer self-closes during the last few inches

**Soft Close** - drawer self-closes softly during the last few inches, prevents door from slamming

**Free Travel** - drawer stays in whatever position it is left

# CHOOSE YOUR DRAWER SLIDE

## CENTER MOUNT DRAWER SLIDE - SEARCH P1175

Cut to any length up to 23 1/2" deep

Bracket Slide  
25lb load capacity

Travel:  
3/4 extension

Bottom, Center mount

Fits most drawers

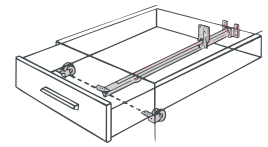

## CENTER MOUNT DRAWER SLIDE - SEARCH P1029

12", 14", 16", 18", 20", 22", 24"

Precision Ball Bearing  
35lb load capacity

Travel:  
3/4 extension

Bottom, Center mount

Precision movement  
ultimate smoothness

Adaptable to cabinets with or without cabinet supports

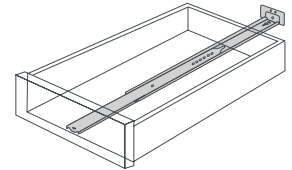

## SIDE MOUNT DRAWER SLIDE - SEARCH P1336

14", 16", 18", 20", 22"

Smooth Glide Rollers  
50lb load capacity

Travel:  
3/4 extension

Self-closing feature  
Easy to install

Standard side mount  
for replacement  
or new construction

Durable epoxy finish

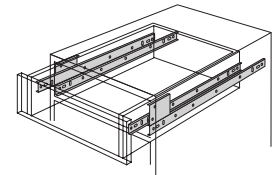

## SIDE MOUNT DRAWER SLIDE - SEARCH P1700

12", 14", 16", 18", 20", 22", 24"

Smooth Glide Roller  
75lb load capacity

Travel:  
3/4 extension

Bottom mount

Heavy Duty  
Maximum Stability

Self-closing feature  
Durable epoxy finish

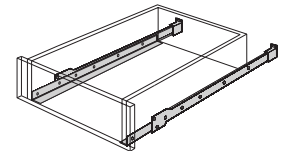

## SIDE MOUNT DRAWER SLIDE - SEARCH P1050, OR P1055 FOR SOFT CLOSE

12", 14", 18", 20", 22", 24"

Smooth Glide Roller  
100lb load capacity

Travel:  
Full extension

Side mount

Application:  
Shallow Drawers

Single captive roller  
for maximum stability

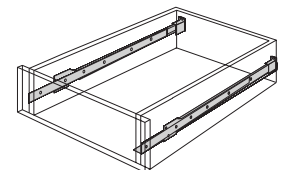

## SIDE MOUNT DRAWER SLIDE - SEARCH P1055

12", 14", 16", 18", 20", 22", 24"

Precision Ball Bearing construction for smooth glide operation

Travel:  
Full extension

100lb load capacity

Allows access to entire drawer, shelf, or pull-out. Ideal for pots & pans

Heavy duty steel

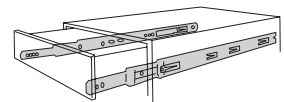

# DRAWER SLIDES

PRODUCT SPECIFICATIONS					FINISH	PART NUMBER			DETAILS
Type	Extension	Slide/ Mount	Load Capacity			Part	Length (Inches)	Finish Code	
<b>A</b>	Ball Bearing	Full	Undermount	75 lb.	Cadmium	HH075213	18"	2C	Soft close, Smooth glide operation, Vertical adjustment via front locking clips, Handed
<b>B</b>	Ball Bearing	Full	Undermount	75 lb.	Cadmium	HH075214	21"	2C	Soft close, Smooth glide operation, Vertical adjustment via front locking clips, Handed
<b>C</b>	Rear Mount Socket	-	-	-	Cadmium	HH075215	-	2C	For use with HH075213 & HH075214 undermount drawer slides, Metal, Sold in pairs
<b>D</b>	Ball Bearing	3/4	Center Mount	35 lb.	Cadmium	P1029/	12, 14, 16, 18, 20, 22, 24	2C	Smooth glide operation, Friction disconnect, Sold singularly
<b>E</b>	Ball Bearing	Full	Side mount	100 lb.	Cadmium	P1050/	12, 14, 16, 18, 20, 22, 24	2C	Smooth glide operation, Non-handed with lever disconnect, Sold in pairs
<b>F</b>	Ball Bearing	Full	Side mount	100 lb.	Cadmium	P1055/	12, 14, 16, 18, 20, 22, 24	2C	Soft close, Smooth glide operation, Non-handed with lever disconnect, Sold in pairs
<b>G</b>	Rear Mount Bracket	-	-	-	Cadmium	P1056/BKT	-	2C	For use with P1050 & P1055 side mount drawer slides, Metal, Sold in pairs
<b>H</b>	Mono Rail	3/4	Bottom Mount	25 lb.	Cadmium	P1175	Custom	2C	Cuts to any length, Fits most drawers up to 22" drawer length, Sold singularly
<b>I</b>	Roller, Single Extension	3/4	Side mount	50 lb.	White	P1336/	14, 18, 20, 22	2C	Two tier, Self-closing, Handed, Stop lever and lift-out disconnect, Durable epoxy finish
<b>J</b>	Roller, Single Extension	3/4	Bottom Mount	75 lb.	White	P1700/	12, 14, 16, 18, 20, 22, 24	W	Self-closing, Handed, Lift out disconnect, Durable epoxy finish
<b>K</b>	Rear Mount Bracket	-	-	-	White	P1700/BKT	-	W	For use with P1700-W on face frame cabinets, Plastic, Sold in pairs
<b>L</b>	Roller, Single Extension	3/4	Side mount	75 lb.	White	P1750/	12, 14, 16, 18, 20, 22, 24	W	Self-closing, Handed, Lift out disconnect, Durable epoxy finish

Record the "Part Number" including the hyphen followed by the "Finish Code." Example: P1050/12-2C for 12" length.





## VARIOUS FINISHES

Not to Scale

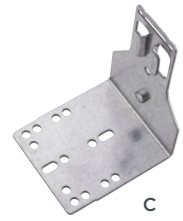
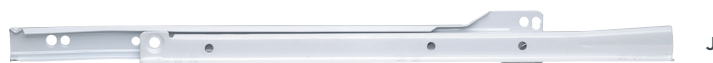
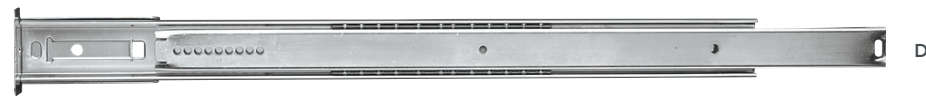
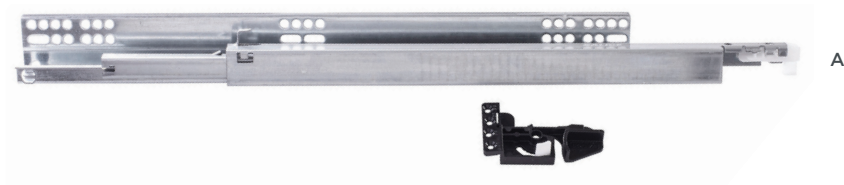

# HINGE GENERAL GUIDELINES

## REPLACEMENT

To update the finish, choose the same style. New holes in the cabinet might be required if the style is not the same.

## HINGE QUANTITY

- 2 Hinges: up to 35" door height 20 lbs.
- 3 Hinges: up to 63" door height 20-40 lbs.
- 4 Hinges: up to 78" door height 40-60 lbs.
- 5 Hinges: up to 94" door height 60-80 lbs.

## WHAT TYPE OF CABINET DO YOU HAVE?

**Face Frame:** The cabinet face is constructed of vertical "stiles" and horizontal "rails" that reinforce the cabinet structure and provide mounting support for doors and drawers.

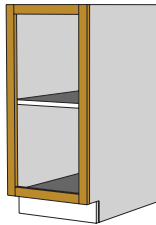

**Frameless:** The cabinet is constructed without any face framing. Doors and drawers are mounted to the sides of the cabinet. Fully concealed hinges are used for the doors.

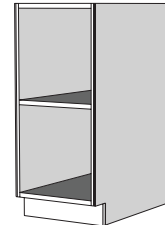

## WHAT TYPE OF DOOR DO YOU HAVE?

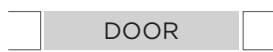

**Flush or Full Inset Door:** Sits completely within cabinet opening, has no edges to grab onto and needs hardware to pull open. Ideally used with face frame cabinets.

**Partial Inset Door:** Sits partially in cabinet opening and partially across face of cabinet.

**Partial Overlay:** Must be attached to a framed cabinetry. Cabinet door sits slightly apart from one another, revealing a piece of the face frame.

**Full Overlay:** Sits fully across face of cabinet with no reveal.

## MEASURING OVERLAY

1. Close Cabinet Door.
2. Use pencil and make a small mark on the cabinet frame directly against the hinged side of the door.
3. Open the cabinet door (or remove the door) and measure from the pencil mark to the opening of the cabinet.

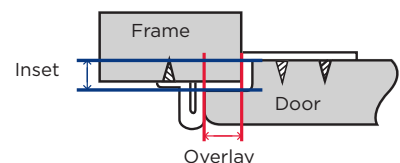
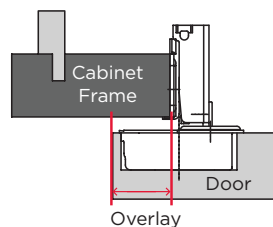
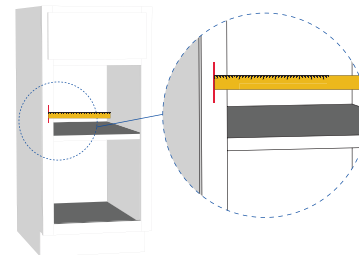
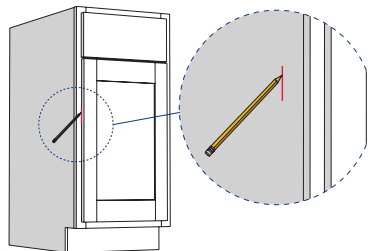

# CHOOSE YOUR HINGE

Do you want decorative (surface), purely functional (concealed) or both (semi-concealed)? Now that you know the type of cabinet & door you have, with an overlay measurement, you can choose from a variety of hinge styles to fit your needs. The hinge you choose may have more than one trait.

## VISIBILITY

**Surface:** The hinge mounting is visible, mounted on the outside of the cabinet.

**Concealed:** The hinge is hidden, mounted on the inside of the cabinet.

**Semi-Concealed:** A part of the hinge is showing, typically the cabinet wing is exposed and the door wing is concealed.

## CLOSING

**Soft Closing:** Door self closes softly during the last few inches, prevents door from slamming.

**Self Closing:** Door self closes during the last few inches.

**Free Swinging:** No built-in closing mechanism, door prone to slamming.

## WRAP

**Full Wrap:** Wraps around three sides of the cabinet body.

**Partial Wrap:** Wraps around two sides of the cabinet body.

## FLUSH OR INSET

**Flush:** Hinge door wing mounts straight across back of door.

**Inset:** Hinge door wing is shaped to fit 3/8" rabbet on doors for partial inset applications.

## CONCEALED, SOFT CLOSE

**Concealed:** The hinge is hidden, mounted on the inside of the cabinet.  
**Soft Close:** Door self closes softly during the last few inches, prevents door from slamming.



**Face Frame**

- 106° Opening
- With 1/2", 3/4", 1-1/4" and 1-3/8" Overlays
- Polished Nickel Finish
- HH74716-14 Shown

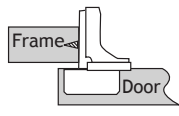

**Frameless**

- 105° Opening, Full Overlay
- Titanium Finish
- HH74723-TT Shown

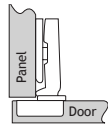

**Frameless**

- 105° Opening, Full Overlay
- Polished Nickel Finish
- HH74720-14 Shown

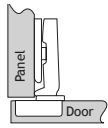

**Frameless**

- 105° Opening, Half Overlay
- Polished Nickel Finish
- HH74721-14 Shown

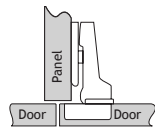

**Frameless**

- 105° Opening, Inset
- Polished Nickel Finish
- HH74722-14 Shown

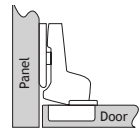

## CONCEALED, SELF CLOSING

**Concealed:** The hinge is hidden, mounted on the inside of the cabinet.  
**Self Closing:** Door self closes during the last few inches.



**Face Frame**

- With 1/2", 3/4", 1-1/4" and 1-3/8" Overlays
- Polished Nickel Finish
- P5124-14 Shown

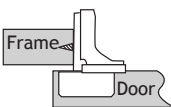

**Frameless**

- Full Overlay
- Polished Nickel Finish
- P5105-14 Shown

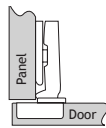

**Frameless**

- Half Overlay
- Polished Nickel Finish
- P5110-14 Shown

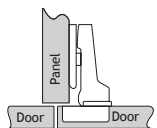

**Frameless**

- Inset
- Polished Nickel Finish
- P5115-14 Shown

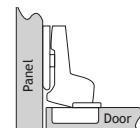

**Frameless**

- 90° Opening
- Frameless, or Inset
- Self-closing
- Polished Nickel Finish
- P6992-C Shown
- All frameless configurations shown left are possible.

# HINGE TYPES

## SURFACE MOUNT

The hinge mounting is visible on the outside of the cabinet



### Free Swinging

- Face Frame
- 3/8" Inset
- Without Spring
- Search P140

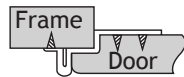

### Free Swinging

- Face Frame
- Without Spring
- Search P139

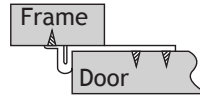

### Surface Face Mounted

- Flush / Full Inset Doors
- Fully exposed
- Search P106, P148



### Surface Self-Closing

- 3/8" Inset
- Face Frame
- Semi-concealed
- Search P143, P243, P295

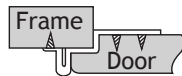

### Surface Self-Closing

- Face Frame
- Semi-concealed
- Search P144, P244 & P296

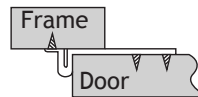

## SELF MORTISE

Only the knuckle and pin are visible.



### Self Mortised

- Flush / Full Inset
- Semi-concealed
- Search P8293, P8294

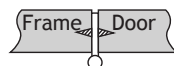

## SEMI-CONCEALED WRAP

A part of the hinge is showing, typically the cabinet wing is exposed and the door wing is concealed. Wraps around cabinet body.



### Semi-Concealed

- Partial Wrap
- 1/4" Overlays
- 3/8" Inset
- Search P61030F



### Semi-Concealed

- Partial Wrap
- 1/4" Overlays
- Search P60010F



### Semi-Concealed

- Full Wrap
- 1/2" Overlays
- Search P5710F



### Semi-Concealed

- Partial Wrap
- 1/2" Overlays
- Search P2710F

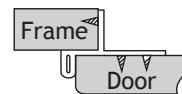
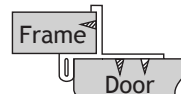
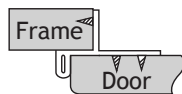

## DEMOUNTABLE

Demountable hinges are made for those who want to remove a cabinet door frequently, without having to unscrew and re-screw the hinges.



### Single Demountable

- Self-Closing
- 1/2" Overlay
- Search P5313

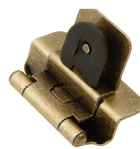

### Double Demountable

- Self-Closing
- 1/4" Overlays
- 3/8" Inset
- Search P5312



### Double Demountable

- Self-Closing
- 1/4" overlay, search P5311
- 1/2" overlay, search P5310

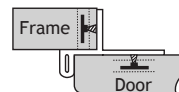
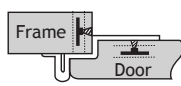
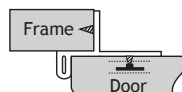

# SURFACE FREE SWINGING HINGES

PRODUCT SPECIFICATIONS   VARIABLE OVERLAY FOR FACE FRAME		PART NUMBER	FINISH	
Hinge Type	Quantity			
<b>A</b>	Flush	Sold in Pairs	P139-26	Chrome
<b>B</b>	3/8" Inset	Sold in Pairs	P140-26	Chrome
<b>C</b>	Flush	Sold in Pairs	P139-SN	Satin Nickel
<b>D</b>	3/8" Inset	Sold in Pairs	P140-SN	Satin Nickel
<b>E</b>	Flush	Sold in Pairs	P139-3	Polished Brass
<b>F</b>	3/8" Inset	Sold in Pairs	P140-3	Polished Brass
<b>G</b>	Flush	Sold in Pairs	P139-AB	Antique Brass
<b>H</b>	3/8" Inset	Sold in Pairs	P140-AB	Antique Brass
<b>I</b>	Flush	Sold in Pairs	P139-VB	Vintage Bronze
<b>J</b>	3/8" Inset	Sold in Pairs	P140-VB	Vintage Bronze

Record the "Part Number" including the hyphen followed by the "Finish Code."

## VARIOUS FINISHES

54% Scale

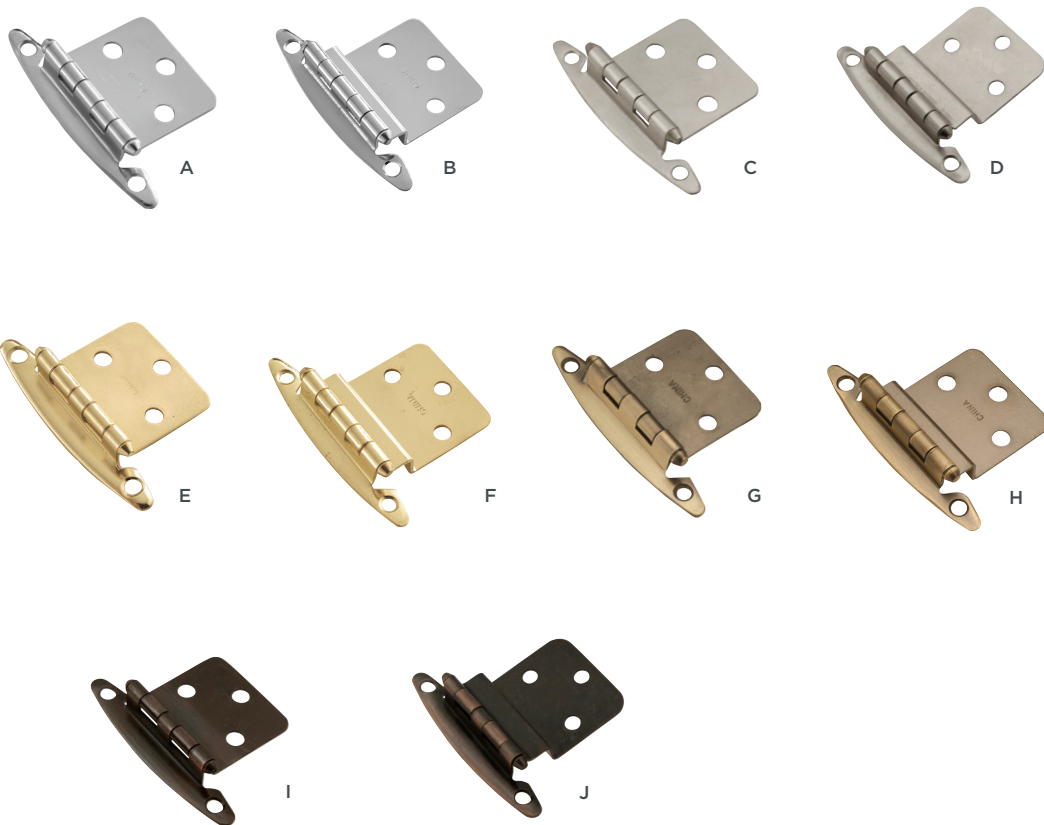

# SURFACE FACE MOUNT HINGES

PRODUCT SPECIFICATIONS   SOLD IN PAIRS					PART NUMBER	FINISH
	C/C	L	W	Hinge Type		
<b>A</b>	2-1/2"	3-7/16"	1-1/4"	Flush	P148-AB	Antique Brass
<b>B</b>	2-1/2"	3-7/16"	1-1/4"	Flush	P106-AC	Antique Copper
<b>C</b>	2-1/2"	3-7/16"	1-1/4"	Flush	P106-CB	Colonial Black

Record the "Part Number" including the hyphen followed by the "Finish Code."

## VARIOUS FINISHES

54% Scale

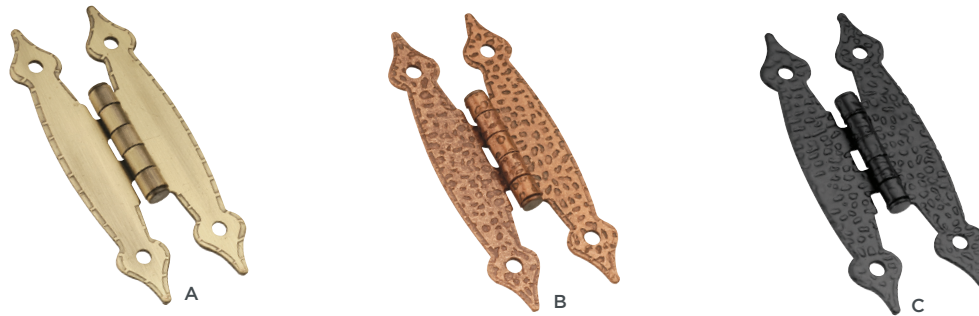

# ACCESSORIES

PRODUCT SPECIFICATIONS	PART NUMBER	FINISH	DETAILS	
<b>Type</b>				
<b>A</b>	Bumper	H076929-CL	Clear	Self-adhesive vinyl bumper to prevent door slamming, Pack of 20
<b>B</b>	Spacer	V08H076998	Polished Nickel	For face frame Euro hinges to adjust overlay, 1/32" thickness, Metal, Pack of 8

Record the "Part Number" including the hyphen followed by the "Finish Code."



A



B

# SURFACE SELF-CLOSING HINGES

PRODUCT SPECIFICATIONS   VARIABLE OVERLAY FOR FACE FRAME			PART NUMBER	FINISH
	Hinge Type	Quantity		
<b>A</b>	Flush	Sold in Pairs	P144-26	Chrome
<b>B</b>	3/8" Inset	Sold in Pairs	P143-26	Chrome
<b>C</b>	Flush	Sold in Pairs	P244-CLX	Chromolux
<b>D</b>	3/8" Inset	Sold in Pairs	P243-CLX	Chromolux
<b>E</b>	Flush	Sold in Pairs	P244-SN	Satin Nickel
<b>F</b>	3/8" Inset	Sold in Pairs	P243-SN	Satin Nickel
<b>G</b>	Flush	Sold in Pairs	P244-VP	Vibra Pewter
<b>H</b>	3/8" Inset	Sold in Pairs	P243-VP	Vibra Pewter
<b>I</b>	Flush	Sold in Pairs	P144-3	Polished Brass
<b>J</b>	3/8" Inset	Sold in Pairs	P143-3	Polished Brass
<b>K</b>	Flush	Sold in Pairs	P244-WOA	Windover Antique
<b>L</b>	3/8" Inset	Sold in Pairs	P243-WOA	Windover Antique
<b>M</b>	Flush	Sold in Pairs	P144-AB	Antique Brass
<b>N</b>	3/8" Inset	Sold in Pairs	P143-AB	Antique Brass
<b>O</b>	Flush	Sold in Pairs	P244-AC	Antique Copper
<b>P</b>	3/8" Inset	Sold in Pairs	P243-AC	Antique Copper
<b>Q</b>	Flush	Sold in Pairs	P244-SBZ	Satin Bronze
<b>R</b>	3/8" Inset	Sold in Pairs	P243-SBZ	Satin Bronze
<b>S</b>	Flush	Sold in Pairs	P244-OBH	Oil-Rubbed Bronze Highlighted
<b>T</b>	3/8" Inset	Sold in Pairs	P243-OBH	Oil-Rubbed Bronze Highlighted
<b>U</b>	Flush	Sold in Pairs	P144-BL	Black
<b>V</b>	3/8" Inset	Sold in Pairs	P143-BL	Black
<b>W</b>	Flush	Sold in Pairs	P244-BI	Black Iron
<b>X</b>	3/8" Inset	Sold in Pairs	P243-BI	Black Iron
<b>Y</b>	Flush	Sold in Pairs	P144-W	White
<b>Z</b>	3/8" Inset	Sold in Pairs	P143-W	White
<b>AA</b>	Flush	Sold in Pairs	P296-SN	Satin Nickel
<b>AB</b>	3/8" Inset	Sold in Pairs	P295-SN	Satin Nickel
<b>AC</b>	Flush	Sold in Pairs	P296-SC	Satin Silver Cloud
<b>AD</b>	3/8" Inset	Sold in Pairs	P295-SC	Satin Silver Cloud

Record the "Part Number" including the hyphen followed by the "Finish Code."

## VARIOUS FINISHES

54% Scale

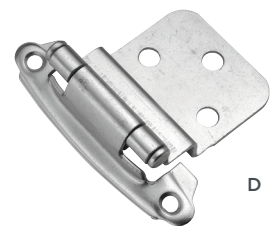
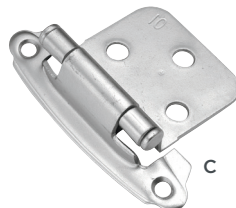
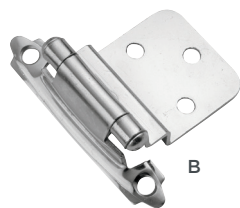
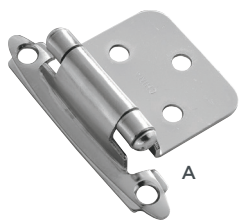



# SURFACE SELF-CLOSING HINGES

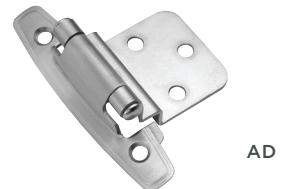
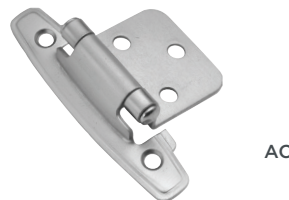
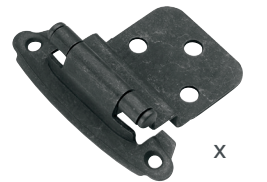
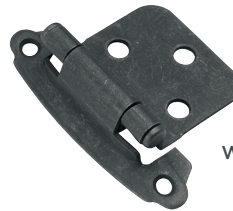
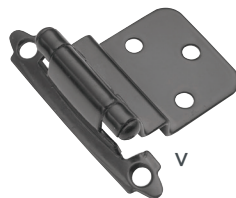
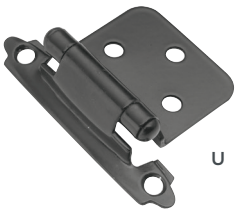
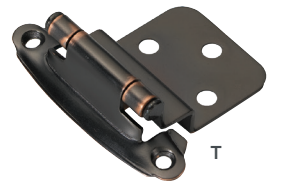
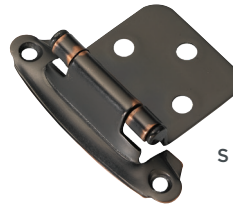
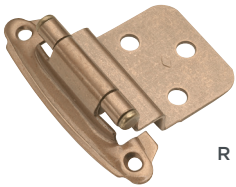
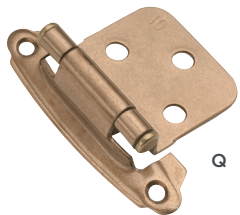
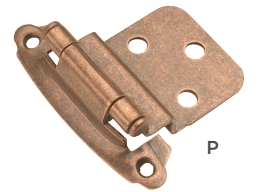
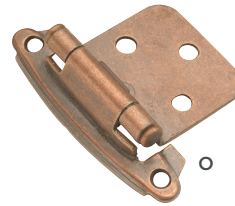
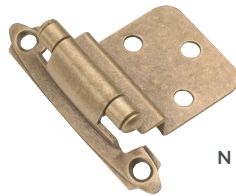
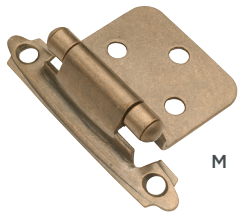
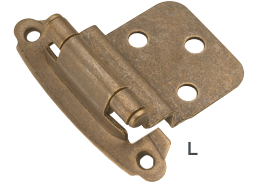
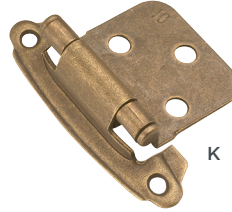
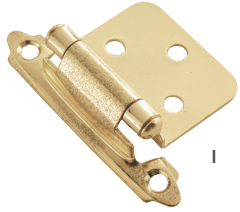
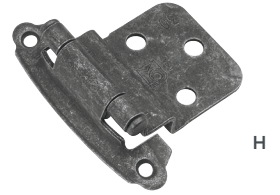
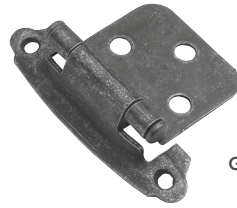
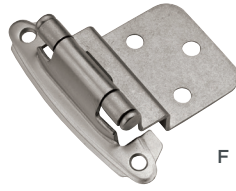
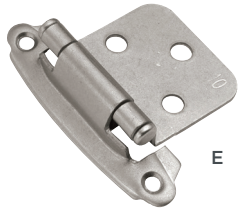

# SELF-CLOSING SEMI CONCEALED WRAP HINGES

PRODUCT SPECIFICATIONS   FOR FACE FRAME				PART NUMBER	FINISH	
Hinge Type	Overlay	Inset	Quantity			
<b>A</b>	Part Wrap	1/4"	-	Sold in Pairs	P60010F-SN	Satin Nickel
<b>B</b>	Part Wrap	1/4"	3/8"	Sold in Pairs	P61030F-SN	Satin Nickel
<b>C</b>	Part Wrap	1/2"	-	Sold in Pairs	P2710F-SN	Satin Nickel
<b>D</b>	Full Wrap	1/2"	-	Sold in Pairs	P5710F-SN	Satin Nickel
<b>E</b>	Part Wrap	1/4"	-	Sold in Pairs	P60010F-3	Polished Brass
<b>F</b>	Part Wrap	1/2"	-	Sold in Pairs	P2710F-3	Polished Brass
<b>G</b>	Full Wrap	1/2"	-	Sold in Pairs	P5710F-3	Polished Brass
<b>H</b>	Part Wrap	1/4"	-	Sold in Pairs	P60010F-AB	Antique Brass
<b>I</b>	Part Wrap	1/4"	3/8"	Sold in Pairs	P61030F-AB	Antique Brass
<b>J</b>	Part Wrap	1/2"	-	Sold in Pairs	P2710F-AB	Antique Brass
<b>K</b>	Full Wrap	1/2"	-	Sold in Pairs	P5710F-AB	Antique Brass
<b>L</b>	Part Wrap	1/4"	-	Sold in Pairs	P60010F-VB	Vintage Bronze
<b>M</b>	Part Wrap	1/4"	3/8"	Sold in Pairs	P61030F-VB	Vintage Bronze
<b>N</b>	Part Wrap	1/2"	-	Sold in Pairs	P2710F-VB	Vintage Bronze
<b>O</b>	Full Wrap	1/2"	-	Sold in Pairs	P5710F-VB	Vintage Bronze
<b>P</b>	Part Wrap	1/2"	-	Sold in Pairs	P2710F-W2	White Powder Coat
<b>Q</b>	Full Wrap	1/2"	-	Sold in Pairs	P5710F-W2	White Powder Coat

Record the "Part Number" including the hyphen followed by the "Finish Code."

# SELF-CLOSING SEMI CONCEALED WRAP HINGES

VARIOUS FINISHES  
Not to Scale

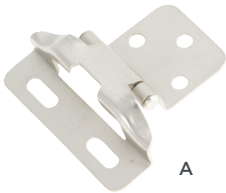

A

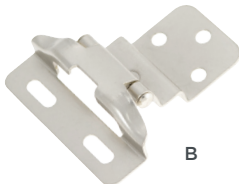

B



C



D

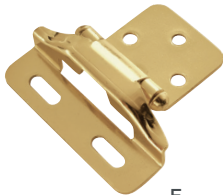

E

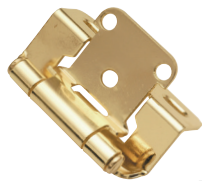

F



G



H

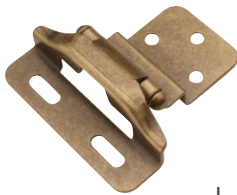

I



J



K



L



M



N



O



P



Q

# DOUBLE DEMOUNTABLE HINGES

PRODUCT SPECIFICATIONS   FOR FACE FRAME			PART NUMBER	FINISH	
Hinge Type	Overlay	Quantity			
<b>A</b>	-	1/2"	Sold in Pairs	P5310-SN	Satin Nickel
<b>B</b>	-	1/4"	Sold in Pairs	P5311-SN	Satin Nickel
<b>C</b>	3/8" Inset	1/4"	Sold in Pairs	P5312-SN	Satin Nickel
<b>D</b>	-	1/2"	Sold in Pairs	P5310-AB	Antique Brass
<b>E</b>	-	1/4"	Sold in Pairs	P5311-AB	Antique Brass
<b>F</b>	3/8" Inset	1/4"	Sold in Pairs	P5312-AB	Antique Brass
<b>G</b>	-	1/2"	Sold in Pairs	P5310-BI	Black Iron
<b>H</b>	-	1/4"	Sold in Pairs	P5311-BI	Black Iron
<b>I</b>	3/8" Inset	1/4"	Sold in Pairs	P5312-BI	Black Iron

Record the "Part Number" including the hyphen followed by the "Finish Code."

## VARIOUS FINISHES

Not to Scale

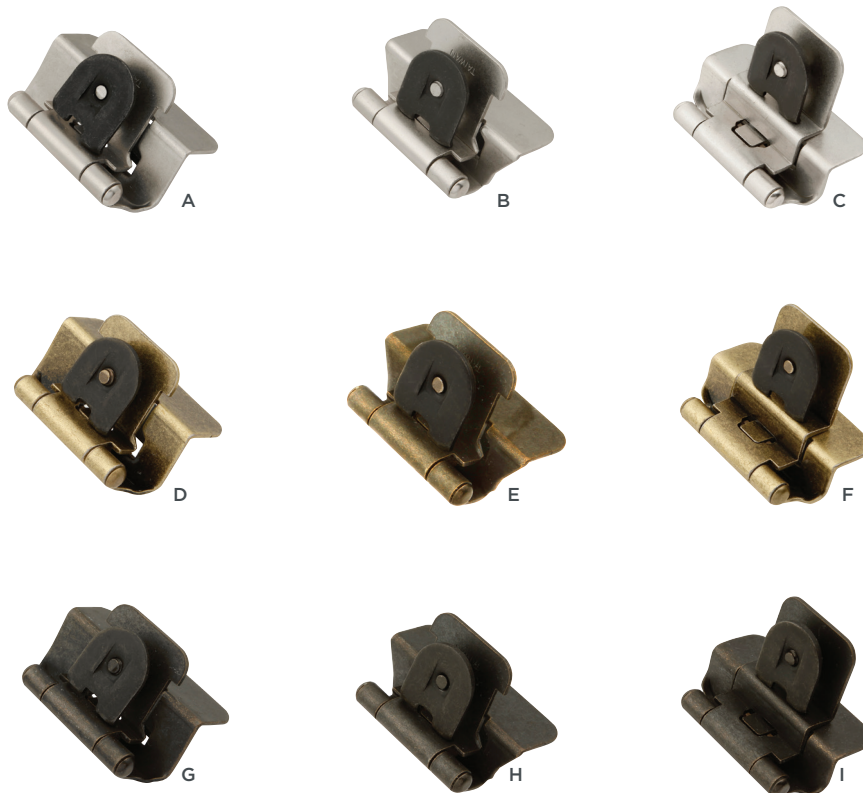

# SINGLE DEMOUNTABLE HINGES

PRODUCT SPECIFICATIONS   FOR FACE FRAME			PART NUMBER	FINISH
Overlay	Quantity			
<b>A</b>	1/2"	Sold in Pairs	P5313-SN	Satin Nickel
<b>B</b>	1/2"	Sold in Pairs	P5313-AB	Antique Brass
<b>C</b>	1/2"	Sold in Pairs	P5313-BI	Black Iron

Record the "Part Number" including the hyphen followed by the "Finish Code."

## VARIOUS FINISHES

Not to Scale

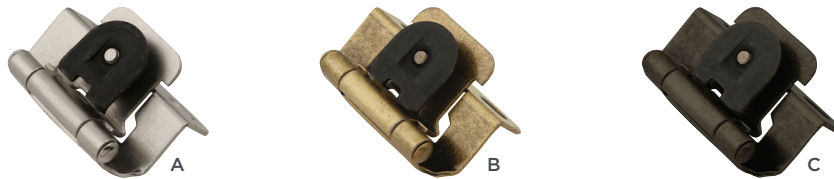

# SELF MORTISE HINGES

PRODUCT SPECIFICATIONS				PART NUMBER	FINISH
L	W	Quantity			
<b>A</b>	2-1/2"	1-1/2"	Sold in Pairs	P8293-SN	Satin Nickel
<b>B</b>	2-1/2"	1-1/2"	Sold in Pairs	P8293-SM	Silver Medallion
<b>C</b>	2-1/2"	1-1/2"	Sold in Pairs	P8293-LP	Lancaster Hand Polished
<b>D</b>	2-1/2"	1-1/2"	Sold in Pairs	P8293-AB	Antique Brass
<b>E</b>	2-1/2"	1-1/2"	Sold in Pairs	P8293-VB	Vintage Bronze
<b>F</b>	2"	1-7/16"	Sold in Pairs	P8294-SN	Satin Nickel
<b>G</b>	2"	1-7/16"	Sold in Pairs	P8294-SM	Silver Medallion
<b>H</b>	2"	1-7/16"	Sold in Pairs	P8294-LP	Lancaster Hand Polished
<b>I</b>	2"	1-7/16"	Sold in Pairs	P8294-AB	Antique Brass
<b>J</b>	2"	1-7/16"	Sold in Pairs	P8294-VB	Vintage Bronze

Record the "Part Number" including the hyphen followed by the "Finish Code."

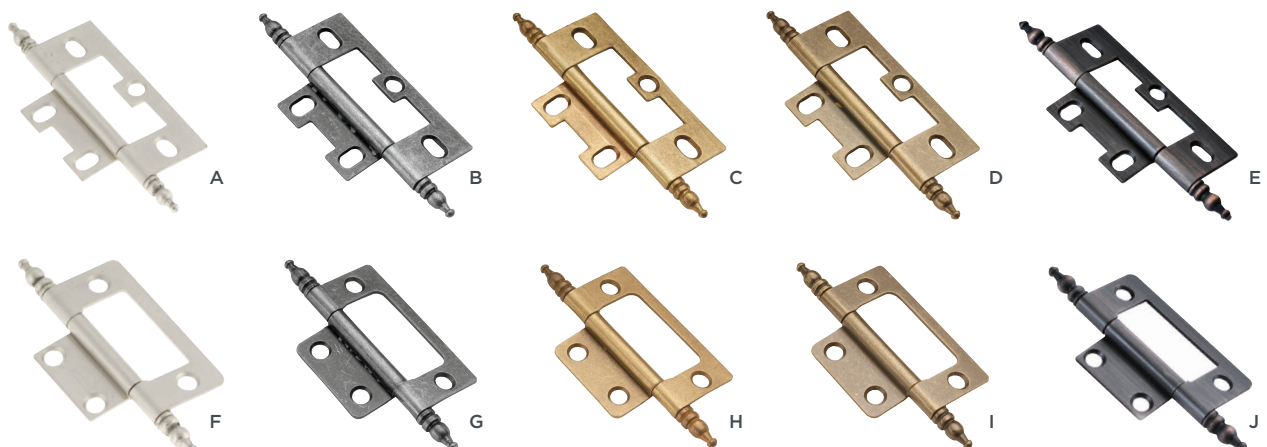

# CONCEALED HINGES

PRODUCT SPECIFICATIONS   SOLD IN PAIRS					PART NUMBER	FINISH	DETAILS
Type	Cabinet Type	Overlay	Opening Degree				
<b>A</b>	Self Close	Frameless	Full	105°	P5105-14	Polished Nickel	Micro side to side adjustment
<b>B</b>	Self Close	Frameless	Full	105°	P5107-14	Polished Nickel	Micro side to side adjustment
<b>C</b>	Self Close	Frameless	Half	105°	P5110-14	Polished Nickel	Snap on, Micro side to side adjustment
<b>D</b>	Self Close	Frameless	Inset	105°	P5115-14	Polished Nickel	Micro side to side adjustment
<b>E</b>	Self Close	Frameless	Full	165°	P5120-14	Polished Nickel	For Lazy Susan or pull out application, Micro side to side adjustment
<b>F</b>	Self Close	Face Frame	1/2"	105°	P5124-14	Polished Nickel	Micro side to side adjustment
<b>G</b>	Self Close	Face Frame	1/2"	105°	P5125-14	Polished Nickel	One piece design, adjustment via mounting screws only
<b>H</b>	Self Close	Face Frame	3/4"	108°	P5127-14	Polished Nickel	Cam depth adjustment, micro side to side adjustment
<b>I</b>	Self Close	Face Frame	1-3/8" (or greater)	108°	P5128-14	Polished Nickel	Face Mount, Micro side to side adjustment
<b>J</b>	Self Close	Face Frame	1-1/4"	108°	P5129-14	Polished Nickel	Cam depth adjustment, micro side to side adjustment
<b>K</b>	Soft Close	Frameless	Full	105°	P5305-14	Polished Nickel	Clip on, Micro side to side adjustment
<b>L</b>	Self Close	Frameless	Variable, Inset	90°	P6992-C	Cadmium	Easy On, Typically for full or half overlay, or full inset

Record the "Part Number" including the hyphen followed by the "Finish Code."



# CONCEALED HINGES

VARIOUS FINISHES  
Not to Scale

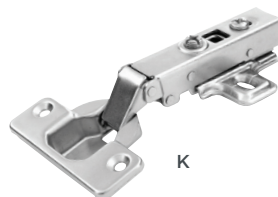
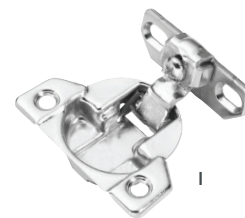
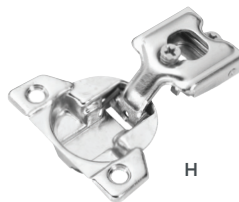
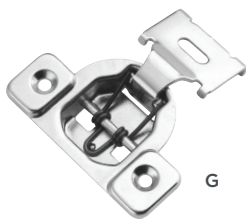
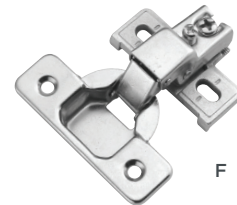
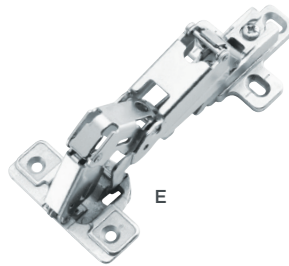
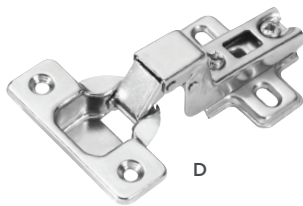
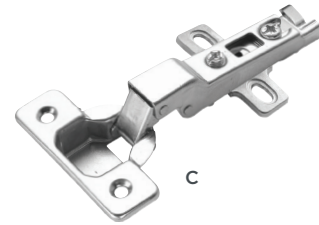
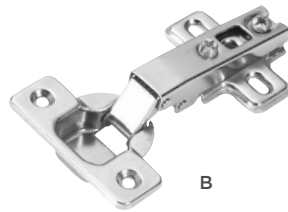
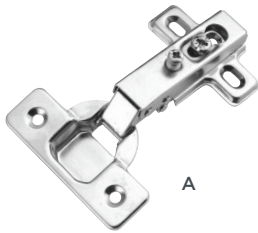

# CONCEALED SELF-CLOSING HINGES

PRODUCT SPECIFICATIONS   SOLD IN PAIRS					PART NUMBER	FINISH	DETAILS
Type	Cabinet Type	Overlay	Opening Degree				
<b>A</b>	Self Close	Face Frame	1/4"	106°	HH075216-14	Polished Nickel	2 cams for depth and vertical adjustment
<b>B</b>	Self Close	Face Frame	1/2"	106°	HH075217-14	Polished Nickel	3 cams for depth, side to side, and vertical adjustment
<b>C</b>	Self Close	Face Frame	3/4"	106°	HH075218-14	Polished Nickel	3 cams for depth, side to side, and vertical adjustment
<b>D</b>	Self Close	Face Frame	1-1/4"	106°	HH075219-14	Polished Nickel	3 cams for depth, side to side, and vertical adjustment
<b>E</b>	Self Close	Face Frame	1-3/8"	106°	HH075220-14	Polished Nickel	3 cams for depth, side to side, and vertical adjustment
<b>F</b>	Self Close	Frameless	Full	110°	HH075221-14	Polished Nickel	Clip on, Cam for vertical adjustment
<b>G</b>	Self Close	Frameless	Half	110°	HH075222-14	Polished Nickel	Clip on, Cam for vertical adjustment
<b>H</b>	Self Close	Frameless	Inset	110°	HH075223-14	Polished Nickel	Clip on, Cam for vertical adjustment
<b>I</b>	Self Close	Frameless	Full	165°	HH075224-14	Polished Nickel	Clip on, Cam for vertical adjustment
<b>J</b>	Self Close, Corner	Frameless	-	94°	HH075225-14	Polished Nickel	45 degree corner doors, cam for side to side adjustment
<b>K</b>	Self Close, Blind Corner	Frameless	-	94°	HH075226-14	Polished Nickel	Cam for vertical adjustment
<b>L</b>	Self Close, Pie Corner	Frameless	-	70°	HH75110-14	Polished Nickel	Cam for side to side adjustment
<b>M</b>	Hinge Mounting Plate, 0mm	Frameless	-	-	HH075227-14	Polished Nickel	2 cams for depth and vertical adjustment, For use with clip on hinge
<b>N</b>	Hinge Mounting Plate, 1mm	Face Frame	-	-	HH075228-14	Polished Nickel	2 cams for depth and vertical adjustment, For use with clip on hinge

Record the "Part Number" including the hyphen followed by the "Finish Code."

## VARIOUS FINISHES

Not to Scale

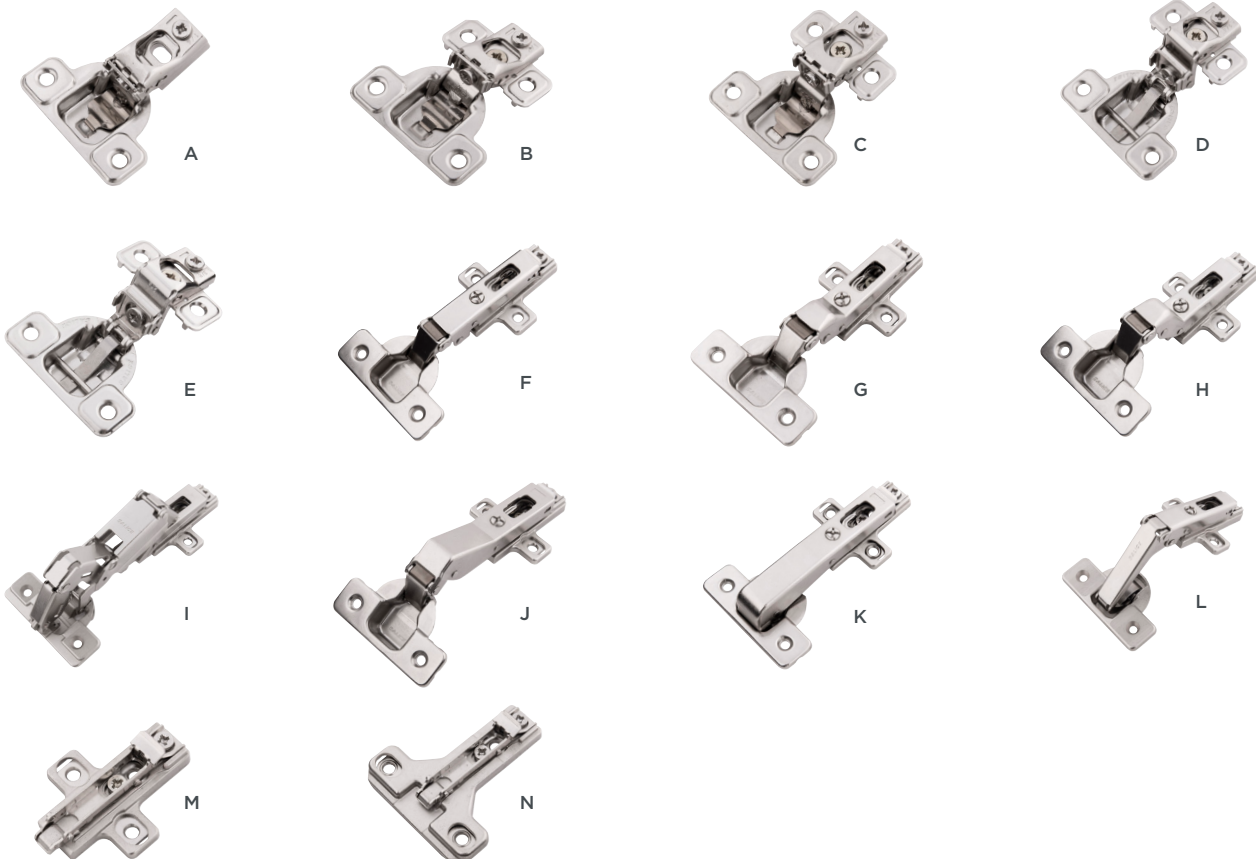



# CONCEALED SOFT CLOSE HINGES

PRODUCT SPECIFICATIONS   SOLD IN PAIRS					PART NUMBER	FINISH	DETAILS
Type	Cabinet Type	Overlay	Opening Degree				
<b>A</b>	Soft Close	Face Frame	1/2"	106°	HH74716-14	Polished Nickel	2 cams for depth and side to side adjustment, Soft close adjustment feature
<b>B</b>	Soft Close	Face Frame	3/4"	106°	HH74717-14	Polished Nickel	2 cams for depth and side to side adjustment, Soft close adjustment feature
<b>C</b>	Soft Close	Face Frame	1-1/4"	106°	HH74718-14	Polished Nickel	2 cams for depth and side to side adjustment, Soft close adjustment feature
<b>D</b>	Soft Close	Face Frame	1-3/8"	106°	HH74719-14	Polished Nickel	2 cams for depth and side to side adjustment, Soft close adjustment feature
<b>E</b>	Soft Close	Frameless	Full	105°	HH74720-14	Polished Nickel	Clip on, Cam for vertical adjustment, Soft close adjustment feature
<b>F</b>	Soft Close	Frameless	Half	105°	HH74721-14	Polished Nickel	Clip on, Cam for vertical adjustment, Soft close adjustment feature
<b>G</b>	Soft Close	Frameless	Inset	105°	HH74722-14	Polished Nickel	Clip on, Cam for vertical adjustment, Soft close adjustment feature
<b>H</b>	Soft Close	Frameless	Full	105°	HH74723-TT	Titanium	Clip on, Cam for vertical adjustment, Soft close adjustment feature
<b>I</b>	Universal Soft Close Damper	Frameless	-	-	HH74724-14	Polished Nickel	For use with Self Close Hinges, Tension adjustment, One per door, Sold singularly

Record the "Part Number" including the hyphen followed by the "Finish Code."

## VARIOUS FINISHES

Not to Scale

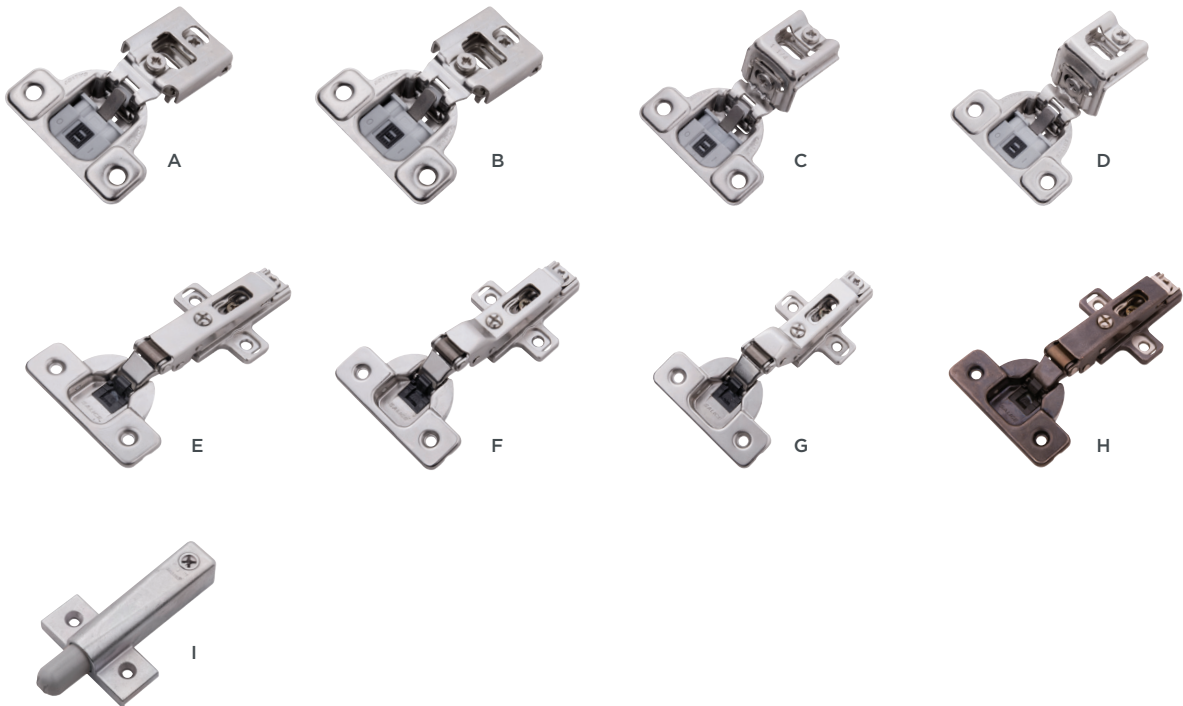

# CATCHES

PRODUCT SPECIFICATIONS					PART NUMBER	FINISH CODE			
C/C	L	W	P	Cadmium		Statuary Bronze	White	Tan Plastic	
A	15/16"	1-1/4"	1-1/8"	9/16"	P107-	2C	-	-	-
B	15/16"	1-1/4"	1-1/8"	9/16"	P657-	-	STB	-	-
C	1-3/8"	1-3/4"	1"	5/8"	P108-	2C	-	-	-
D	2"	2-7/16"	1-1/16"	11/16"	P149-	2C	-	-	-
E	2"	2-1/2"	1-1/16"	13/16"	P151-	2C	-	-	-
F	2"	2-1/2"	1-1/16"	13/16"	P651-	-	STB	-	-
G	2"	2-7/16"	1-1/8"	11/16"	P649-	-	STB	-	-
H	1-1/2"	1-13/16"	3/4"	9/16"	P659-	-	STB	-	-
I	1-7/16"	1-13/16"	11/16"	1/2"	P109-	-	2C	W	-
J	1-3/8"	1-15/16"	11/16"	1/2"	P650-	-	STB	W	-
K	1-5/8"	2"	1-3/16"	1/2"	P110-	-	-	W	TP
L	7/8"	1-3/4"	1-1/8"	11/16"	P655-	-	STB	-	-
M	22mm	1-13/16"	1-3/16"	3/4"	P655-	-	-	W	-
N	5/8"	1-5/16"	1-3/16"	1-1/16"	P654-	-	STB	-	-

Record the "Part Number" including the hyphen followed by the "Finish Code." Example: P107-2C

## VARIOUS FINISHES

Not to Scale



# HAND RAIL BRACKETS

	PRODUCT SPECIFICATIONS			PART NUMBER	FINISH
	L	W	P		
<b>A</b>	3"	2"	3-1/8"	HH57738-SN	Satin Nickel
<b>B</b>	3"	2"	3-1/8"	HH57738-PB	Polished Brass
<b>C</b>	3"	2"	3-1/8"	HH57738-AB	Antique Brass
<b>D</b>	3"	2"	3-1/8"	HH57738-10B	Oil-Rubbed Bronze
<b>E</b>	3"	2"	3-1/8"	HH57738-W	White

Record the "Part Number" including the hyphen followed by the "Finish Code."

## VARIOUS FINISHES

Not to Scale



# MOUNTING TEMPLATES

PRODUCT SPECIFICATIONS			PART NUMBER	EXTRAS
Application	Template	Package		
<b>A</b> Mounting Kit for 35MM Hidden Hinges	L:2-1/2" W:2-1/4" P:3/8"	L:5" W: 5" P:1-1/2"	PBH3100	Kit includes 35mm Forstner drill bit
<b>B</b> Cabinet Door Precision Alignment Guide	L:6" W:2-9/16" P:1/2"	L:8" W:3-1/2" P:1-1/8"	PBH3104	-
<b>C</b> Cabinet Door and Drawer Precision Alignment Guides with 3/16" Drill Bit	(Door): L:6" W:2-9/16" P:1/2" (Drawer): L:6" W:5-3/8" P:5/8"	L:9" W: 6-5/8" P:1-1/4"	PBH3103	Kit includes 3/16" drill bit
<b>D</b> Cabinet Drawer Precision Alignment Guide	L:6" W:5-3/8" P:5/8"	L:8" W:6-5/8" P:1-1/4"	PBH3101	-

Record the "Part Number." Example: PBH3103

VARIOUS STYLES  
Not to Scale



A



B



C



D



FUNCTIONAL

# PROJECT PACKS™

	PRODUCT SPECIFICATIONS					QUANTITY	PART NUMBER	FINISH
	C/C	L	W	P	Package Dimensions			
<b>A</b>	3"	5"	1/2"	1"	L:7-1/8" W:5-1/2" P:2"	10	VP14174-SN	Satin Nickel
<b>B</b>	3" & 96mm	4"	1/2"	1"	L:7-1/8" W:5-9/16" P:2-1/16"	10	VP3447-SN	Satin Nickel
<b>C</b>	3"	4-1/8"	9/16"	1"	L:7-1/8" W:5-1/2" P:2-3/8"	10	VP3448-SN	Satin Nickel
<b>D</b>	3"	4-3/4"	1/2"	7/8"	L: 7-1/8" W:5-1/2" P:2"	10	VP135-SN	Satin Nickel
<b>E</b>	96mm	4-3/4"	7/16"	1"	L: 7-1/8" W:5-1/2" P:2"	10	VPA0221-SN	Satin Nickel
<b>F</b>	3"	5"	11/16"	1"	L:7-1/8" W:5-1/2" P: 1-13/16"	10	VP14444-SN	Satin Nickel
<b>G</b>	3"	5"	11/16"	1"	L:7-1/8" W:5-1/2" P:2"	10	VP14444-OBH	Oil-Rubbed Bronze Highlighted
<b>H</b>	3"	5"	11/16"	1"	L:7-1/8" W:5-1/2" P:2"	10	VP14444-W	White
<b>I</b>	3"	5-1/2"	1/2"	1-1/4"	L: 8-1/8" W: 4-7/16" H: 2"	10	V10HH075593-SS	Stainless Steel
<b>J</b>	3"	5-1/2"	1/2"	1-1/4"	L: 8-1/8" W: 4-7/16" H: 2"	10	V10HH075593-VB	Vintage Bronze
<b>K</b>	3"	3-1/2"	7/16"	1"	L: 7-1/8" W:5-1/2" P:2"	10	VP3465-SN	Satin Nickel
<b>L</b>	3"	3-1/2"	7/16"	1"	L:7-1/8" W:5-1/2" P:2"	10	VP3465-VB	Vintage Bronze
<b>M</b>	3"	4-9/16"	1/2"	15/16"	L:7-1/8" W:5-1/2" P:2"	10	VP3113-OBH	Oil-Rubbed Bronze Highlighted

Record the "Part Number" including the hyphen followed by the "Finish Code."

## VARIOUS FINISHES

Not to Scale. Project Packs™ available in clamshell packaging.



A



B



C



D



Example package for VP14174-SN



E



F



G



H



I



J



K



L



M

PRODUCT SPECIFICATIONS					QUANTITY	PART NUMBER	FINISH
P	D	B	Package Dimensions				
A	1"	1-1/8"	1/2"	L:8-7/8" W:4-1/8" P:1-1/2"	10	VP14255-26	Chrome
B	1"	1-1/8"	1/2"	L:8-7/8" W:4-1/8" P:1-1/2"	10	VP14255-SN	Satin Nickel
C	1"	1-1/8"	1/2"	L:8-7/8" W:4-1/8" P:1-1/2"	10	VP14255-OBH	Oil-Rubbed Bronze Highlighted
D	1-1/8"	1-1/4"	5/8"	L:9-1/2" W:4" P:1-1/2"	10	VPA1218-SN	Satin Nickel
E	11/16"	1-1/4"	3/8"	L:8-7/8" W:4-1/8" P:1-1/2"	10	VP121-SN	Satin Nickel
F	1"	1-3/8"	5/8"	L:8-7/8" W:4-1/8" P:1-1/2"	10	VP14848-SN	Satin Nickel
G	1"	1-3/8"	5/8"	L:8-7/8" W:4-1/8" P:1-1/2"	10	VP14848-W	White
H	1"	1-3/8"	5/8"	L:8-7/8" W:4-1/8" P:1-1/2"	10	VP3464-SN	Satin Nickel
I	1"	1-3/8"	5/8"	L:8-7/8" W:4-1/8" P:1-1/2"	10	VP3464-VB	Vintage Bronze

Record the "Part Number" including the hyphen followed by the "Finish Code."

**VARIOUS FINISHES**

Not to Scale. Project Packs™ available in clamshell packaging.

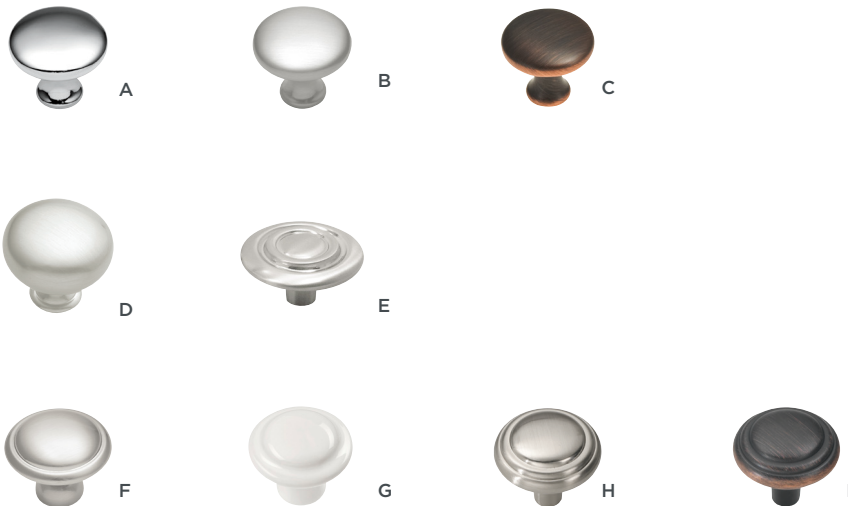

Example package for VP14255-26

# PROJECT PACKS™

PRODUCT SPECIFICATIONS					QTY.	PART NUMBER	FINISH
	Hinge Type	Cabinet Type	Overlay	Package Dimensions			
<b>A</b>	Concealed	Face Frame	1/2"	L:8-1/4" W:3-3/4" P:2-7/8"	10	VP5125-14	Polished Nickel
<b>B</b>	Concealed	Face Frame	1/2"	L:8-1/4" W:3-7/8" P:2-7/8"	10	VP5124-14	Polished Nickel
<b>C</b>	Self-Closing Flush Mount	Face Frame	Variable	L:7-1/4" W:7-1/4" P:2-3/8"	20	VP244-SN	Satin Nickel
<b>D</b>	Self-Closing Flush Mount	Face Frame	Variable	L:7-1/4" W:7-1/4" P:2-3/8"	20	VP244-OBH	Oil-Rubbed Bronze Highlighted

Record the "Part Number" including the hyphen followed by the "Finish Code."  
 For further product details on A and B see page 214 and for further details on C and D see page 208.

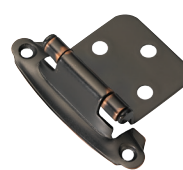
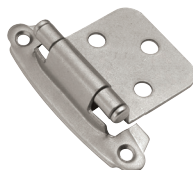
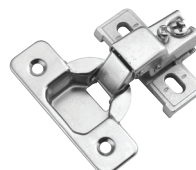



# SCREW PACKS

PRODUCT SPECIFICATIONS			QUANTITY	PART NUMBER
Screw Type	Package Dimensions			
<b>A</b>	#8 - 32 x 1"	L:4-1/16" W:1-13/16" P:1/2"	15	VP5000
<b>B</b>	#8 - 32 x 1-1/4"	L:4-1/16" W:1-13/16" P:1/2"	15	VP5001
<b>C</b>	#8 - 32 x 1-1/2"	L:4-1/16" W:1-13/16" P:1/2"	10	VP5002
<b>D</b>	#8 - 32 x 1-3/4"	L:4-1/16" W:1-13/16" P:1/2"	10	VP5003
<b>E</b>	#8 - 32 x 2"	L:4-1/16" W:1-13/16" P:1/2"	10	VP5004

Record the "Part Number." Example: VP5002



# MULTI PACKS

PRODUCT SPECIFICATIONS						QUANTITY	PART NUMBER	FINISH	
C/C	L	W	P	Package Dimensions					
A	5/8"	3-1/4"	1-1/8"	2-7/8"	L:6-1/2" W:4-1/8" P:1-1/8"		2	V02P27120-CH	Chrome
B	5/8"	3-1/4"	1-1/8"	2-7/8"	L:6-1/2" W:4-1/8" P:1-1/8"		2	V02P27120-SC	Satin Silver Cloud
C	5/8"	3-1/4"	1-1/8"	2-7/8"	L:6-1/2" W:4-1/8" P:1-1/8"		2	V02P27120-W	White
D	5/8"	3-1/4"	1-1/8"	2-7/8"	L:6-1/2" W:4-1/8" P:1-1/8"		2	V02P27120-PB	Polished Brass
E	5/8"	3-1/4"	1-1/8"	2-7/8"	L:6-1/2" W:4-1/8" P:1-1/8"		2	V02P27120-AB	Antique Brass
F	5/8"	3-1/4"	1-1/8"	2-7/8"	L:6-1/2" W:4-1/8" P:1-1/8"		2	V02P27120-BL	Black

Record the "Part Number" including the hyphen followed by the "Finish Code."

**VARIOUS FINISHES**  
 Not to Scale. Project Packs™  
 available in carded packaging.

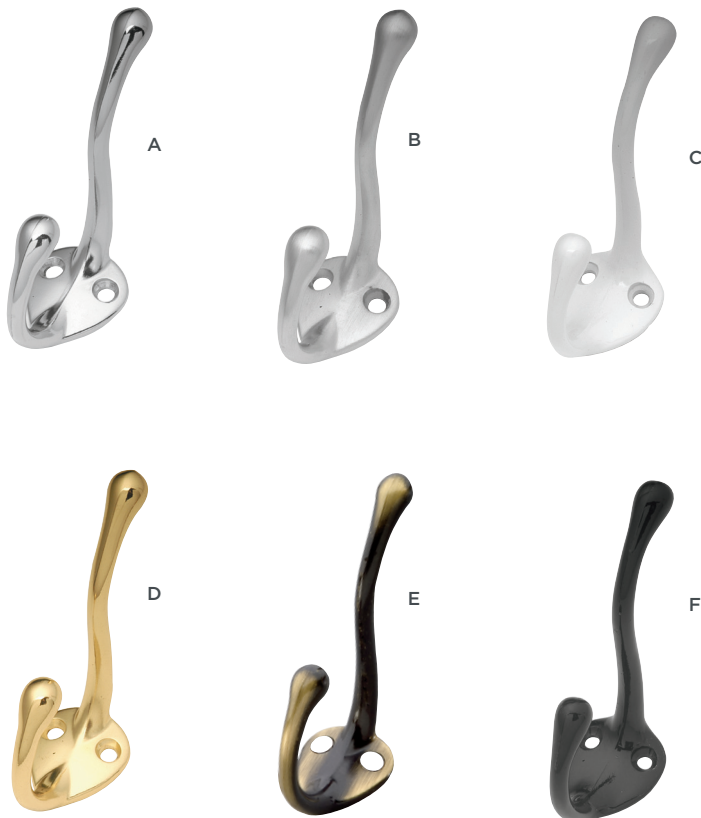

Example package for  
 V02P27120-CH

# MULTI PACKS

PRODUCT SPECIFICATIONS					QUANTITY	PART NUMBER	FINISH	
C/C	L	W	P	Package Dimensions				
<b>A</b>	5/8"	3-1/4"	1-1/8"	1", 2-7/8"	L:8" W:6-3/4" P:1"	4	V04P27120-SC	Satin Silver Cloud
<b>B</b>	5/8"	3-1/4"	1-1/8"	1", 2-7/8"	L:8" W:6-3/4" P:1"	4	V04P27120-PB	Polished Brass
<b>C</b>	5/8"	3-1/4"	1-1/8"	1", 2-7/8"	L:8" W:6-3/4" P:1"	4	V04P27120-AB	Antique Brass

Record the "Part Number" including the hyphen followed by the "Finish Code."

**VARIOUS FINISHES**  
 Not to Scale. Project Packs™ available in carded packaging.



A



B



C



Example package for V04P27120-SC



# ELECTRONIC KEYPAD DEADBOLT



CONTEMPORARY  
Model shown: HH075773-SN



TRADITIONAL  
Model shown: HH075772-SN



TRANSITIONAL  
MODEL SHOWN: HH075774-SN

## TOP FEATURES



### SECURITY

- ANSI/BHMA Grade 2-3 security
- Back-up key override
- Limited lifetime mechanical warranty
- 1-year electrical warranty
- Automatic relocking mode



### CONVENIENCE

- No need to carry keys
- Easy installation with a screw driver
- Fits both right and left hand doors
- Backlit keypad for increased visibility
- Low battery indicator



### CONTROL

- Up to 10 sets of user codes
- Multiple user codes can be turned off as needed (vacation mode)
- Operated by 4 AA batteries (not included)
- Single entry code for one time use only

## YOU ARE IN CONTROL

### EASE AT YOUR FINGERTIPS

Never worry about losing your keys or locking yourself out of your home

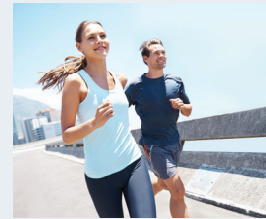

### VACATION MODE

Enable vacation mode and leave your home secure when you are away by turning off multiple user codes



### ONE TIME USE

Provide temporary access to servicers at the click of a button



# ELECTRONIC KEYPAD DEADBOLT

PRODUCT SPECIFICATIONS					PART NUMBER	FINISH CODE		
Style	Grade	Inner Body	Outer Body			Satin Nickel	Polished Brass	Aged Bronze
<b>A</b> Contemporary	3	3-3/16"W x 6-13/16"H x 2-1/16"D	2-11/16"W x 3-7/8"H x 7/8"D		HH075773-	SN	-	ABZ
<b>B</b> Traditional	3	3-3/16"W x 6-13/16"H x 2-1/16"D	2-11/16"W x 3-7/8"H x 7/8"D		HH075772-	SN	PB	ABZ
<b>C</b> Transitional	2	3-3/16"W x 6-13/16"H x 2-1/16"D	2-3/4"W x 5-11/16"H x 1"D		HH075774-	SN	-	ABZ

Record the "Part Number" including the hyphen followed by the "Finish Code." Example: HH075773-SN

**CONTEMPORARY - GRADE 3**  
Not to Scale



A

A

**TRADITIONAL - GRADE 3**  
Not to Scale



B

B

B

**TRANSITIONAL - GRADE 2**  
Not to Scale



C

C

# HICKORY SMART - BLUETOOTH ENABLED DEADBOLT

# HICKORY<sup>®</sup>

S M A R T

The Bluetooth<sup>®</sup> enabled deadbolt, powered by Securemote<sup>™</sup>, guarantees control, security, and convenience.



# HICKORY SMART - BLUETOOTH ENABLED DEADBOLT



## What is Securemote® ?

Securemote® smart technology allows home products to communicate to your smart device when Bluetooth technology is enabled.

All your Securemote smart products can be managed under one platform for full home control, security, and convenience.

## CONTROL

- Control access through your Smartphone or the keypad.
- Unlimited users through the online portal, up to 10 on the app.
- Push notifications alert you when your door is opened.
- Securemote™ Smart technology

## SECURITY

- Auto lock: optional to lock every time you leave your door.
- Vacation Mode
- Grade 3 ANSI/BHMA Security

## CONVENIENCE

- Works with IOS and Android.
- Bluetooth® Low Energy supports long battery life: 18-24 months
- Illuminated keys

PRODUCT SPECIFICATIONS					PART NUMBER	FINISH
Style	Grade	Inner Body	Outer Body			
<b>A</b>	Traditional	3	3-3/16"W x 6-13/16"H x 2-1/16"D	2-11/16"W x 3-7/8"H x 7/8"D	H076388-SN	Satin Nickel
<b>B</b>	Traditional	3	3-3/16"W x 6-13/16"H x 2-1/16"D	2-11/16"W x 3-7/8"H x 7/8"D	H076388-PB	Polished Brass
<b>C</b>	Traditional	3	3-3/16"W x 6-13/16"H x 2-1/16"D	2-11/16"W x 3-7/8"H x 7/8"D	H076388-ABZ	Aged Bronze
<b>D</b>	Contemporary	3	3-3/16"W x 6-13/16"H x 2-1/16"D	2-11/16"W x 3-7/8"H x 7/8"D	H076389-SN	Satin Nickel

Record the "Part Number" including the hyphen followed by the "Finish Code."

### TRADITIONAL - GRADE 3



### CONTEMPORARY - GRADE 3



# PRODUCT INDEX

Item #	Page	Item #	Page	Item #	Page	Item #	Page
C02H075744-AL	38	H076128-FUB	19	H076653-IOB	109	H076705-VB	83
C02H075745-AL	38	H076128-SN	18	H076653-14	108	H076706-BGB	81
C02H075746-AL	38	H076129-CH	17	H076653-FUB	109	H076706-BI	83
C02H075747-AL	38	H076129-FUB	19	H076653-SN	109	H076706-CH	80
C02H075748-AL	38	H076129-SN	18	H076698-BGB	81	H076706-CP	82
C02H075749-AL	38	H076130-CH	17	H076698-BI	83	H076706-SN	81
CH075750-AL	38	H076130-FUB	19	H076698-CH	80	H076706-VB	83
H076014-14	96	H076130-SN	18	H076698-CP	82	H076929-CL	207
H076014-BI	98	H076131-CH	17	H076698-SN	81	HH074641-FUB	33
H076014-CP	97	H076131-FUB	19	H076698-VB	83	HH074855-14	32
H076014-EGN	97	H076131-SN	18	H076699-BGB	81	HH074855-FUB	33
H076014-SN	97	H076132-CH	17	H076699-BI	83	HH074856-14	32
H076015-14	96	H076132-FUB	19	H076699-CH	80	HH074856-FUB	33
H076015-BI	98	H076132-SN	18	H076699-CP	82	HH074888-14	56
H076015-CP	97	H076133-CH	17	H076699-SN	81	HH074888-OBH	56
H076015-EGN	97	H076133-FUB	19	H076699-VB	83	HH074888-SN	56
H076015-SN	97	H076133-SN	18	H076700-BGB	81	HH075010-BNV	156
H076016-14	96	H076134-CH	17	H076700-BI	83	HH075010-VB	156
H076016-BI	98	H076134-FUB	19	H076700-CH	80	HH075028-BNV	156
H076016-CP	97	H076134-SN	18	H076700-CP	82	HH075028-VB	156
H076016-EGN	97	H076135-CH	17	H076700-SN	81	HH075213-2C	201
H076016-SN	97	H076135-FUB	19	H076700-VB	83	HH075214-2C	201
H076017-14	96	H076135-SN	18	H076701-BGB	81	HH075215-2C	201
H076017-BI	98	H076388-ABZ	231	H076701-BI	83	HH075216-14	216
H076017-CP	97	H076388-PB	231	H076701-CH	80	HH075217-14	216
H076017-EGN	97	H076388-SN	231	H076701-CP	82	HH075218-14	216
H076017-SN	97	H076389-SN	231	H076701-SN	81	HH075219-14	216
H076018-14	96	H076647-IOB	109	H076701-VB	83	HH075220-14	216
H076018-BI	98	H076647-14	108	H076702-BGB	81	HH075221-14	216
H076018-CP	97	H076647-FUB	109	H076702-BI	83	HH075222-14	216
H076018-EGN	97	H076647-SN	109	H076702-CH	80	HH075223-14	216
H076018-SN	97	H076648-IOB	109	H076702-CP	82	HH075224-14	216
H076019-14	96	H076648-14	108	H076702-SN	81	HH075225-14	216
H076019-BI	98	H076648-FUB	109	H076702-VB	83	HH075226-14	216
H076019-CP	97	H076648-SN	109	H076703-BGB	81	HH075227-14	216
H076019-EGN	97	H076649-IOB	109	H076703-BI	83	HH075228-14	216
H076019-SN	97	H076649-14	108	H076703-CH	80	HH076264-FO	31
H076020-14	96	H076649-FUB	109	H076703-CP	82	HH076264-GN	30
H076020-BI	98	H076649-SN	109	H076703-SN	81	HH076264-TN	31
H076020-CP	97	H076650-IOB	109	H076703-VB	83	HH075266-FO	31
H076020-EGN	97	H076650-14	108	H076704-BGB	81	HH075266-GN	30
H076020-SN	97	H076650-FUB	109	H076704-BI	83	HH075266-TN	31
H076021-14	96	H076650-SN	109	H076704-CH	80	HH075267-FO	31
H076021-BI	98	H076651-IOB	109	H076704-CP	82	HH075267-GN	30
H076021-CP	97	H076651-14	108	H076704-SN	81	HH075267-TN	31
H076021-EGN	97	H076651-FUB	109	H076704-VB	83	HH075268-FO	31
H076021-SN	97	H076651-SN	109	H076705-BGB	81	HH075268-GN	30
H076127-CH	17	H076652-IOB	109	H076705-BI	83	HH075268-TN	31
H076127-FUB	19	H076652-14	108	H076705-CH	80	HH075280-FO	31
H076127-SN	18	H076652-FUB	109	H076705-CP	82	HH075280-GN	30
H076128-CH	17	H076652-SN	109	H076705-SN	81	HH075280-TN	31



# PRODUCT INDEX

Item #	Page	Item #	Page	Item #	Page	Item #	Page
HH075281-FO	31	HH075592-MB	16	HH075774-ABZ	229	HH74636-SN	34
HH075281-GN	30	HH075592-RLB	14	HH075774-SN	229	HH74637-BNV	125
HH075281-TN	31	HH075592-SS	12	HH075809-GLCH	132	HH74637-DAC	125
HH075326-14	26	HH075592-VB	15	HH075852-GLSN	132	HH74637-SN	124
HH075326-BGB	29	HH075593-BBLN	15	HH075853-GLSN	132	HH74638-BNV	125
HH075326-EGN	28	HH075593-CH	13	HH075854-GLCH	132	HH74638-DAC	125
HH075326-SS	27	HH075593-MB	16	HH075855-GLCH	132	HH74638-SN	124
HH075326-VB	29	HH075593-RLB	14	HH075857-CA14	132	HH74639-BNV	125
HH075327-14	26	HH075593-SS	12	HH076011-BNV	156	HH74639-DAC	125
HH075327-BGB	29	HH075593-VB	15	HH076011-VB	156	HH74639-SN	124
HH075327-EGN	28	HH075594-BBLN	15	HH076012-BNV	156	HH74641-14	32
HH075327-SS	27	HH075594-CH	13	HH076012-VB	156	HH74641-14	34
HH075327-VB	29	HH075594-MB	16	HH076013-BNV	156	HH74641-RB	35
HH075328-14	26	HH075594-RLB	14	HH076013-VB	156	HH74641-SN	34
HH075328-BGB	29	HH075594-SS	12	HH076264-FO	31	HH74642-14	32
HH075328-EGN	28	HH075594-VB	15	HH076265-FO	31	HH74642-FUB	33
HH075328-SS	27	HH075595-BBLN	15	HH076265-GN	30	HH74670-BNV	127
HH075328-VB	29	HH075595-CH	13	HH076265-TN	31	HH74670-VB	127
HH075329-14	26	HH075595-MB	16	HH076264-GN	30	HH74671-14	34
HH075329-BGB	29	HH075595-RLB	14	HH076266-GN	30	HH74671-RB	35
HH075329-EGN	28	HH075595-SS	12	HH076264-TN	31	HH74671-SN	34
HH075329-SS	27	HH075595-VB	15	HH09747-14	56	HH74673-BNV	125
HH075329-VB	29	HH075596-BBLN	15	HH09747-OBH	56	HH74673-SN	124
HH075336-14	26	HH075596-CH	13	HH09747-SN	56	HH74673-DAC	125
HH075336-BGB	29	HH075596-MB	16	HH57738-10B	219	HH74674-14	34
HH075336-EGN	28	HH075596-RLB	14	HH57738-AB	219	HH74674-RB	35
HH075336-SS	27	HH075596-SS	12	HH57738-PB	219	HH74674-SN	34
HH075336-VB	29	HH075596-VB	15	HH57738-SN	219	HH74679-BNV	127
HH075337-14	26	HH075597-BBLN	15	HH57738-W	219	HH74679-VB	127
HH075337-BGB	29	HH075597-CH	13	HH74549-BNV	125	HH74687-CA14	132
HH075337-EGN	28	HH075597-MB	16	HH74549-DAC	125	HH74688-CA14	132
HH075337-SS	27	HH075597-RLB	14	HH74549-SN	124	HH74689-CA14	132
HH075337-VB	29	HH075597-SS	12	HH74551-14	34	HH74716-14	217
HH075341-14	26	HH075597-VB	15	HH74551-RB	35	HH74717-14	217
HH075341-BGB	29	HH075598-BBLN	15	HH74551-SN	34	HH74718-14	217
HH075341-EGN	28	HH075598-CH	13	HH74552-BNV	127	HH74719-14	217
HH075341-SS	27	HH075598-MB	16	HH74552-VB	127	HH74720-14	217
HH075341-VB	29	HH075598-RLB	14	HH74554-BNV	125	HH74721-14	217
HH075422-14	26	HH075598-SS	12	HH74554-DAC	125	HH74722-14	217
HH075422-BGB	29	HH075598-VB	15	HH74554-SN	124	HH74723-TT	217
HH075422-EGN	28	HH075599-BBLN	15	HH74561-14	32	HH74724-14	217
HH075422-SS	27	HH075599-CH	13	HH74561-FUB	33	HH74728-BI	87
HH075422-VB	29	HH075599-MB	16	HH74630-BNV	127	HH74728-ITN	86
HH075591-BBLN	15	HH075599-RLB	14	HH74630-VB	127	HH74729-BI	87
HH075591-CH	13	HH075599-SS	12	HH74631-14	32	HH74729-ITN	86
HH075591-MB	16	HH075599-VB	15	HH74631-FUB	33	HH74730-BI	87
HH075591-RLB	14	HH075772-ABZ	229	HH74632-14	34	HH74730-ITN	86
HH075591-SS	12	HH075772-PB	229	HH74632-RB	35	HH74731-BI	87
HH075591-VB	15	HH075772-SN	229	HH74632-SN	34	HH74731-ITN	86
HH075592-BBLN	15	HH075773-ABZ	229	HH74636-14	34	HH74732-14	32
HH075592-CH	13	HH075773-SN	229	HH74636-RB	35	HH74732-FUB	33

# PRODUCT INDEX

Item #	Page	Item #	Page	Item #	Page	Item #	Page
HH74733-BI	87	P1029/16-2C	201	P1336/14-2C	201	P144-BL	209
HH74733-ITN	86	P1029/18-2C	201	P1336/18-2C	201	P144-W	209
HH75110-14	216	P1029/20-2C	201	P1336/20-2C	201	P14402-26	113
K48-BNV	102	P1029/22-2C	201	P1336/22-2C	201	P14402-3	115
K48-BNV	182	P1029/24-2C	201	P135-AB	135	P14402-LB	115
K48-OBH	105	P1050/12-2C	201	P135-SN	134	P14402-SN	114
K48-OBH	183	P1050/14-2C	201	P135-VB	135	P14402-VB	117
K48-SS	101	P1050/16-2C	201	P135-WOA	135	P14402-VBZ	116
K48-SS	180	P1050/18-2C	201	P138-AB	130	P14402-W	117
K49-BNV	102	P1050/20-2C	201	P138-SN	129	P14441-26	113
K49-BNV	182	P1050/22-2C	201	P139-26	206	P14441-3	115
K49-OBH	105	P1050/24-2C	201	P139-3	206	P14441-LB	115
K49-OBH	183	P1055/12-2C	201	P139-AB	206	P14441-SN	114
K49-SS	101	P1055/14-2C	201	P139-SN	206	P14444-26	113
K49-SS	180	P1055/16-2C	201	P139-VB	206	P14444-3	115
K50-BNV	102	P1055/18-2C	201	P140-26	206	P14444-LB	115
K50-BNV	182	P1055/20-2C	201	P140-3	206	P14444-OBH	117
K50-OBH	105	P1055/22-2C	201	P140-AB	206	P14444-SN	114
K50-OBH	183	P1055/24-2C	201	P140-SN	206	P14444-VBZ	116
K50-SS	101	P1056/BKT-2C	201	P140-VB	206	P14444-W	117
K50-SS	180	P106-AC	169	P14021-W	117	P14451-26	113
K51-BNV	102	P106-AC	207	P14114-26	134	P14451-3	115
K51-BNV	182	P106-CB	169	P14114-VB	135	P14451-SN	114
K51-OBH	105	P106-CB	207	P14114-WOA	135	P14451-W	117
K51-OBH	183	P107-2C	218	P14170-26	113	P14461-26	113
K51-SS	101	P108-2C	218	P14170-3	115	P14461-LB	115
K51-SS	180	P109-2C	218	P14170-LB	115	P14461-SN	114
K60-15	77	P109-W	218	P14170-SN	114	P14461-VBZ	116
K60-15	173	P110-TP	218	P14170-VBZ	116	P145-AB	169
K60-SS	76	P110-W	218	P14170-W	117	P146-AB	169
K60-SS	174	P111-26	51	P14174-26	113	P14630-W	117
K61-15	77	P113-26	51	P14174-3	115	P148-AB	169
K61-15	173	P114-3	51	P14174-SN	114	P148-AB	207
K61-SS	76	P115-26	51	P14174-VBZ	116	P14848-26	113
K61-SS	174	P116-3	51	P14174-W	117	P14848-3	115
K62-15	77	P117-AB	130	P14255-26	113	P14848-LB	115
K62-15	173	P117-SN	129	P14255-3	115	P14848-SN	114
K62-SS	76	P1175-2C	201	P14255-LB	115	P14848-VB	117
K62-SS	174	P118-AB	130	P14255-OBH	117	P14848-VBZ	116
K63-15	77	P119-AB	130	P14255-SN	114	P14848-W	117
K63-15	173	P119-SN	129	P14255-VB	117	P149-2C	218
K63-SS	76	P121-AB	130	P14255-VBZ	116	P151-2C	218
K63-SS	174	P121-SN	129	P14255-W	117	P1700/12-W	201
K65-SN	49	P126-AB	130	P143-26	208	P1700/14-W	201
PI-W	144	P126-SN	129	P143-3	209	P1700/16-W	201
PI01-AC	169	P128-AB	130	P143-AB	209	P1700/18-W	201
PI01-CB	169	P128-SN	129	P143-BL	209	P1700/20-W	201
PI02-AC	169	P131-AB	130	P143-W	209	P1700/22-W	201
PI02-CB	169	P132-AB	130	P144-26	208	P1700/24-W	201
PI029/12-2C	201	P132-SN	129	P144-3	209	P1700/BKT-W	201
PI029/14-2C	201	P133-AB	130	P144-AB	209	P1750/12-W	201

# PRODUCT INDEX

Item #	Page	Item #	Page	Item #	Page	Item #	Page
P1750/14-W	201	P2144-SS	66	P2157-SN	67	P2182-BI	164
P1750/16-W	201	P2145-CH	188	P2157-VB	69	P221-VC	144
P1750/18-W	201	P2145-SN	188	P2158-BGB	68	P222-LP	144
P1750/20-W	201	P2146-SN	67	P2158-CH	65	P222-SN	143
P1750/22-W	201	P2146-SN	172	P2158-SN	67	P222-SNB	143
P1750/24-W	201	P2146-SS	66	P2158-VB	69	P222-VC	144
P180-UW	165	P2146-SS	172	P2159-BGB	68	P2240-BNV	84
P183-UW	165	P2147-SN	67	P2159-CH	65	P2240-CH	84
P184-UW	165	P2147-SN	172	P2159-SN	67	P2240-OBH	85
P185-UW	165	P2147-SS	66	P2159-VB	69	P2241-BNV	84
P186-UW	165	P2147-SS	172	P2161-SN	49	P2241-CH	84
P201-LP	139	P2148-SN	67	P2162-SN	49	P2241-OBH	85
P2011-BYA	153	P2148-SN	172	P2163-CH	42	P2242-BNV	84
P2011-RI	153	P2148-SS	66	P2163-OBH	44	P2242-CH	84
P2011-VP	153	P2148-SS	172	P2163-SN	43	P2242-OBH	85
P2014-RI	153	P2149-BGB	68	P2163-SS	42	P2243-BNV	84
P2014-VP	153	P2149-CH	65	P2164-OBH	44	P2243-CH	84
P2023-BYA	153	P2149-SN	67	P2164-SN	43	P2243-OBH	85
P2023-RI	153	P2149-SS	66	P2164-SS	42	P2279-14	89
P2023-VP	153	P2149-VB	69	P2165-OBH	44	P2279-14	178
P208-26	51	P2150-10B	75	P2165-SN	43	P2279-OBH	95
P208-SS	51	P2150-14	74	P2166-SN	43	P2279-OBH	179
P208-UB	51	P2150-OBH	75	P2166-SN	175	P2279-SN	91
P213-26	51	P2150-SN	74	P2167-SN	43	P2279-SN	178
P214-3	51	P2150-WOA	75	P2167-SN	175	P2279-SS	90
P2140-BGB	68	P2151-10B	75	P2168-SN	43	P2279-SS	179
P2140-CH	64	P2151-14	74	P2168-SN	175	P2279-VBZ	94
P2140-SN	67	P2151-OBH	75	P2170-BI	151	P2279-VBZ	179
P2140-SS	66	P2151-SN	74	P2170-CH	150	P2280-OBH	111
P2140-VB	69	P2151-WOA	75	P2170-OBH	151	P2280-SN	110
P2141-BGB	68	P2152-10B	75	P2170-WOA	150	P2280-SS	111
P2141-BLN	69	P2152-14	74	P2171-BI	151	P2281-OBH	111
P2141-CH	64	P2152-OBH	75	P2171-CH	150	P2281-SN	110
P2141-SN	67	P2152-SN	74	P2171-OBH	151	P2281-SS	111
P2141-SS	66	P2152-WOA	75	P2171-WOA	150	P2282-OBH	111
P2141-VB	69	P2153-10B	75	P2172-BI	151	P2282-SN	110
P2142-BGB	68	P2153-14	74	P2172-CH	150	P2282-SS	111
P2142-BLN	69	P2153-OBH	75	P2172-OBH	151	P2283-OBH	111
P2142-CH	64	P2153-SN	74	P2172-WOA	150	P2283-SN	110
P2142-SN	67	P2153-WOA	75	P2173-BI	151	P2283-SS	111
P2142-SS	66	P2155-10B	189	P2173-CH	150	P2286-OBH	111
P2142-VB	69	P2155-14	189	P2173-OBH	151	P2286-SN	110
P2143-BGB	68	P2155-OBH	189	P2173-WOA	150	P2286-SS	111
P2143-BLN	69	P2155-SN	189	P2174-BI	151	P2288-OBH	111
P2143-CH	64	P2155-WOA	189	P2174-CH	150	P2288-OBH	185
P2143-SN	67	P2156-BGB	68	P2174-OBH	151	P2288-SN	110
P2143-SS	66	P2156-CH	65	P2174-WOA	150	P2288-SN	184
P2143-VB	69	P2156-SN	67	P2175-BI	190	P2288-SS	111
P2144-BGB	68	P2156-VB	69	P2175-CH	190	P2288-SS	184
P2144-CH	64	P2157-BGB	68	P2175-OBH	190	P2289-OBH	111
P2144-SN	67	P2157-CH	65	P2175-WOA	190	P2289-OBH	185

# PRODUCT INDEX

Item #	Page	Item #	Page	Item #	Page	Item #	Page
P2289-SN	110	P2710F-W2	211	P3002-RI	159	P3015-BGB	93
P2289-SN	184	P27115-AB	194	P3003-BI	161	P3015-CP	93
P2289-SS	111	P27115-BL	194	P3003-RI	159	P3015-OBH	95
P2289-SS	184	P27115-CH	194	P3004-BI	161	P3015-SN	91
P243-AC	209	P27115-PB	194	P3004-RI	159	P3015-SS	90
P243-BI	209	P27115-SC	194	P3005-BI	161	P3015-VBZ	94
P243-CLX	208	P27115-VB	194	P3005-BI	177	P3016-14	89
P243-OBH	209	P27115-W	194	P3005-RI	159	P3016-14	178
P243-SBZ	209	P2712-MB	47	P3005-RI	177	P3016-OBH	95
P243-SN	209	P27120-AB	195	P3006-BI	161	P3016-OBH	179
P243-VP	209	P27120-BL	195	P3006-BI	177	P3016-SN	91
P243-WOA	209	P27120-CH	195	P3006-RI	159	P3016-SN	178
P244-AC	209	P27120-PB	195	P3006-RI	177	P3017-14	89
P244-BI	209	P27120-SC	195	P3008-OBH	111	P3017-14	178
P244-CLX	208	P27120-W	195	P3008-OBH	185	P3017-OBH	95
P244-OBH	209	P277-LP	139	P3008-SN	110	P3017-OBH	179
P244-SBZ	209	P28-W	144	P3008-SN	184	P3017-SN	91
P244-SN	209	P282-LP	139	P3008-SS	111	P3017-SN	178
P244-VP	209	P29-W	144	P3008-SS	184	P3018-14	89
P244-WOA	209	P2911-MB	51	P3010-14	89	P3018-BGB	93
P25020-CH	193	P2911-SN	49	P3010-BGB	93	P3018-CP	93
P25020-SN	193	P2921-MB	51	P3010-CP	93	P3018-OBH	95
P25021-BGB	192	P2921-SN	50	P3010-OBH	95	P3018-SN	91
P25021-CH	192	P2922-MB	51	P3010-SN	91	P3019-14	89
P25021-SN	192	P2922-SN	50	P3010-SS	90	P3019-BGB	93
P25024-CH	193	P2925-MB	51	P3010-VBZ	94	P3019-CP	93
P25024-SN	193	P2925-SN	50	P3011-14	89	P3019-OBH	95
P25025-CH	193	P295-SC	209	P3011-BGB	93	P3019-SN	91
P25025-SN	193	P295-SN	209	P3011-CP	93	P3026-14	89
P25026-CH	193	P296-SC	209	P3011-OBH	95	P3026-BGB	93
P25026-SN	193	P296-SN	209	P3011-SN	91	P3026-CP	93
P25029-BGB	194	P2994-BI	161	P3011-SS	90	P3026-OBH	95
P25029-CH	194	P2994-RI	159	P3011-VBZ	94	P3026-SN	91
P25029-SN	194	P2995-BI	161	P3012-14	89	P3027-14	89
P252-LP	139	P2995-RI	159	P3012-BGB	93	P3027-BGB	93
P2622-SN	49	P2996-BI	161	P3012-CP	93	P3027-CP	93
P2623-MB	51	P2996-RI	159	P3012-OBH	95	P3027-OBH	95
P2623-SN	49	P2997-BI	161	P3012-SN	91	P3027-SN	91
P2626-MB	119	P2997-RI	159	P3012-SS	90	P3028-14	88
P27100-AB	195	P2998-BI	161	P3012-VBZ	94	P3028-BGB	93
P27100-BL	195	P2998-RI	159	P3013-14	88	P3028-CP	93
P27100-CH	195	P2999-BI	161	P3013-BGB	93	P3028-OBH	95
P27100-PB	195	P2999-BI	177	P3013-CP	93	P3028-SN	91
P27100-RB	195	P2999-RI	159	P3013-OBH	95	P3040-SN	50
P27100-SC	195	P2999-RI	177	P3013-SN	91	P3041-IOB	23
P27100-VB	195	P3-W	144	P3013-SS	90	P3041-14	20
P27100-W	195	P3000-BI	161	P3013-VBZ	94	P3041-SS	21
P2710F-3	211	P3000-RI	159	P3014-14	88	P3041-WOA	23
P2710F-AB	211	P3001-BI	161	P3014-OBH	95	P3042-SN	49
P2710F-SN	211	P3001-RI	159	P3014-SN	91	P3043-SN	49
P2710F-VB	211	P3002-BI	161	P3015-14	88	P3050-IOB	107

# PRODUCT INDEX

Item #	Page	Item #	Page	Item #	Page	Item #	Page
P3050-15	100	P3055-SS	101	P3118-14	55	P3235-OBH	73
P3050-BNV	102	P3055-VB	106	P3118-SN	55	P3235-SN	70
P3050-CH	99	P3060-BI	154	P3119-14	54	P3236-BGB	72
P3050-DAC	104	P3060-DAC	154	P3119-SN	54	P3236-CH	71
P3050-OBH	105	P3060-WOA	154	P3123-14	52	P3236-OBH	73
P3050-PB	103	P3061-BI	154	P3123-SN	53	P3236-SN	70
P3050-SS	101	P3061-DAC	154	P3125-14	54	P3237-BGB	72
P3050-VB	106	P3061-WOA	154	P3125-SN	54	P3237-CH	71
P3051-10B	107	P3062-BI	154	P3151-10B	79	P3237-OBH	73
P3051-15	100	P3062-DAC	154	P3151-CH	77	P3237-SN	70
P3051-BNV	102	P3062-WOA	154	P3151-SN	77	P3238-BGB	72
P3051-CH	99	P3063-BI	154	P3151-VB	79	P3238-CH	71
P3051-DAC	104	P3063-WOA	154	P3163-VB	136	P3238-OBH	73
P3051-OBH	105	P3064-BI	154	P318-LP	139	P3238-SN	70
P3051-PB	103	P3064-DAC	154	P3180-WOA	119	P324-CH	51
P3051-SS	101	P3064-WOA	154	P3181-CH	42	P324-SN	49
P3051-VB	106	P3077-10B	79	P3181-MB	44	P324-SS	51
P3052-10B	107	P3077-SN	77	P3181-OBH	44	P3240-BGB	72
P3052-15	100	P3077-SS	76	P3181-SN	43	P3240-CH	71
P3052-BNV	102	P3077-VB	79	P3181-SS	42	P3240-OBH	73
P3052-CH	99	P3083-FN	52	P3181-WOA	44	P3240-SN	70
P3052-DAC	104	P3090-RB	141	P3190-DAC	41	P326-LP	139
P3052-OBH	105	P3091-RB	141	P3190-SN	41	P326-ST	138
P3052-PB	103	P3092-RB	141	P3190-WOA	41	P329-LP	139
P3052-SS	101	P3093-RB	141	P320-26	134	P329-ST	139
P3052-VB	106	P3094-RB	141	P321-LP	139	P330-26	134
P3053-10B	107	P3094-SAS	122	P321-ST	139	P330-VB	135
P3053-15	100	P3100-OBH	133	P3221-SN	50	P330-WOA	135
P3053-BNV	102	P3100-SN	133	P3222-SN	50	P3303-SN	133
P3053-CH	99	P3101-OBH	133	P3230-BGB	72	P333-26	134
P3053-DAC	104	P3101-SN	133	P3230-CH	71	P3330-CH	58
P3053-OBH	105	P3103-OBH	133	P3230-OBH	73	P3330-SS	58
P3053-PB	103	P3103-SN	133	P3230-SN	70	P3331-SS	58
P3053-SS	101	P3104-OBH	133	P3231-BGB	72	P3332-SS	58
P3053-VB	106	P3104-SN	133	P3231-CH	71	P3333-SS	58
P3054-10B	107	P3111-14	52	P3231-OBH	73	P3334-SS	58
P3054-15	100	P3111-OBH	53	P3231-SN	70	P335-26	134
P3054-BNV	102	P3111-SN	53	P3232-BGB	72	P3370-10B	23
P3054-CH	99	P3111-WOA	53	P3232-CH	71	P3370-14	20
P3054-DAC	104	P3112-14	55	P3232-OBH	73	P3370-SS	21
P3054-OBH	105	P3112-OBH	55	P3232-SN	70	P3370-WOA	23
P3054-PB	103	P3112-SN	55	P3233-BGB	72	P3371-10B	23
P3054-SS	101	P3113-14	54	P3233-CH	71	P3371-14	20
P3054-VB	106	P3113-OBH	54	P3233-OBH	73	P3371-SS	21
P3055-10B	107	P3113-SN	54	P3233-SN	70	P3371-WOA	23
P3055-15	100	P3113-WOA	54	P3234-BGB	72	P3372-10B	23
P3055-BNV	102	P3114-14	55	P3234-CH	71	P3372-14	20
P3055-CH	99	P3114-OBH	55	P3234-OBH	73	P3372-SS	21
P3055-DAC	104	P3114-SN	55	P3234-SN	70	P3372-WOA	23
P3055-OBH	105	P3117-14	52	P3235-BGB	72	P3374-10B	23
P3055-PB	103	P3117-SN	53	P3235-CH	71	P3374-14	20

# PRODUCT INDEX

Item #	Page	Item #	Page	Item #	Page	Item #	Page
P3374-SS	21	P3463-VB	142	P3703-CABGB	25	P577-SN	138
P3374-WOA	23	P3473-ST	139	P3703-CACH	24	P60010F-3	211
P3375-10B	23	P3477-ST	139	P3703-CASN	25	P60010F-AB	211
P3375-14	20	P3500-10B	79	P3704-CABGB	25	P60010F-SN	211
P3375-SS	21	P3500-SN	77	P3704-CACH	24	P60010F-VB	211
P3375-WOA	23	P3500-SS	76	P3704-CASN	25	P602-PR	144
P3380-10B	79	P3500-VB	79	P3708-CABGB	25	P603-PR	144
P3380-SN	77	P3501-10B	79	P3708-CACH	24	P6088-26	51
P3380-SS	76	P3501-SN	77	P3708-CASN	25	P61030F-AB	211
P3380-VB	79	P3501-SS	76	P3709-CABGB	25	P61030F-SN	211
P3381-10B	79	P3501-VB	79	P3709-CACH	24	P61030F-VB	211
P3381-SN	77	P3503-BNV	122	P3709-CASN	25	P630-W	144
P3381-SS	76	P3503-SAS	122	P3711-CABGB	25	P638-BL	143
P3381-VB	79	P3503-VB	122	P3711-CACH	24	P649-STB	218
P3382-10B	79	P3562-DAC	164	P3711-CASN	25	P650-STB	218
P3382-SN	77	P3563-DAC	164	P406-LP	139	P650-W	218
P3382-SS	76	P3564-DAC	163	P413-VB	135	P651-STB	218
P3382-VB	79	P3565-DAC	163	P427-26W	143	P654-STB	218
P3430-SAS	123	P3590-SN	45	P427-SNB	143	P655-STB	218
P3430-VB	123	P3590-VB	45	P427-W	144	P655-W	218
P3431-SAS	123	P3591-SN	45	P431-VB	135	P657-STB	218
P3431-VB	123	P3591-VB	45	P5105-14	215	P659-STB	218
P3432-SAS	123	P3592-SN	57	P5107-14	215	P673-UW	165
P3432-VB	123	P3592-VB	57	P5110-14	215	P674-UW	165
P3433-SAS	123	P3593-SN	57	P5115-14	215	P676-UW	165
P3433-VB	123	P3593-VB	57	P5120-14	215	P684-UW	165
P3440-SNB	46	P3594-SN	37	P5124-14	215	P685-UW	165
P3440-SNWM	46	P3594-VB	37	P5125-14	215	P687-UW	165
P3441-SNB	46	P3595-SN	37	P5127-14	215	P69-W	144
P3441-SNWM	46	P3595-VB	37	P5128-14	215	P6992-C	215
P3443-BNV	163	P3600-BNV	122	P5129-14	215	P7-W	144
P3444-BNV	163	P3600-SAS	122	P513-SN	138	P703-W	144
P3447-MB	47	P3600-VB	122	P5305-14	215	P705-LU	132
P3447-SN	47	P3601-BNV	122	P5310-AB	212	P710-CH	143
P3447-VB	47	P3601-SAS	122	P5310-BI	212	P710-SNW	143
P3448-MB	47	P3601-VB	122	P5310-SN	212	P7301-VP	166
P3448-SN	47	P3608-VB	136	P5311-AB	212	P7302-VP	166
P3448-VB	47	P3616-SN	49	P5311-BI	212	P7303-VP	166
P3450-BI	136	P3635-CABGB	25	P5311-SN	212	P7304-VP	166
P3450-DAC	136	P3635-CACH	24	P5312-AB	212	P7343-VB	136
P3451-BI	136	P3635-CASN	25	P5312-BI	212	P7344-VB	136
P3451-DAC	136	P3670-BI	164	P5312-SN	212	P7351-BYA	153
P3453-SN	142	P3671-BI	164	P5313-AB	213	P7351-RI	153
P3454-SN	142	P3672-BI	164	P5313-BI	213	P744-SNW	143
P3455-SS	131	P3691-SP	52	P5313-SN	213	P744-W	144
P3456-SS	131	P3697-FCH	40	P548-CH	134	P7522-SN	49
P3460-BNV	142	P3699-CHSP	40	P5710F-3	211	P7523-SN	49
P3460-VB	142	P3701-TCH	40	P5710F-AB	211	P7524-SN	49
P3461-BNV	142	P3702-CABGB	25	P5710F-SN	211	P7525-AP	148
P3461-VB	142	P3702-CACH	24	P5710F-VB	211	P7525-WDA	148
P3463-BNV	142	P3702-CASN	25	P5710F-W2	211	P7526-AP	148

# PRODUCT INDEX

Item #	Page	Item #	Page	Item #	Page	Item #	Page
P7526-WDA	148	P8294-SN	213	PA1322-RI	149	VP14174-SN	222
P7527-AP	148	P8294-VB	213	PA1323-BI	149	VP14255-26	223
P7527-WDA	148	P864-W	59	PA1323-RI	149	VP14255-OBH	223
P7528-AP	148	P865-LAD	59	PA1512-VP	166	VP14255-SN	223
P7528-WDA	148	P867-BL	59	PA1513-VP	166	VP14444-OBH	222
P7529-AP	148	P877-LAD	59	PBH3100	220	VP14444-SN	222
P7529-WDA	148	PA0111-VP	166	PBH3101	220	VP14444-W	222
P770-10B	79	PA0112-VP	166	PBH3103	220	VP14848-SN	223
P770-CH	77	PA0114-VP	166	PBH3104	220	VP14848-W	223
P770-SN	77	PA0115-VP	166	PW353-22	61	VP244-OBH	224
P770-SS	76	PA0121-VP	166	PW353-24	61	VP244-SN	224
P770-VB	79	PA0122-VP	166	PW354-22	61	VP3113-OBH	222
P771-10B	79	PA0211-MB	51	PW354-24	61	VP3447-SN	222
P771-CH	77	PA0211-SN	49	PW355-22	61	VP3448-SN	222
P771-SN	77	PA0213-MB	51	PW355-24	61	VP3464-SN	223
P771-SS	76	PA0213-SN	49	PW355-28	60	VP3464-VB	223
P771-VB	79	PA0221-SN	50	PW396-22	61	VP3465-SN	222
P796-CH	143	PA0222-SN	49	PW553-SN	60	VP3465-SN	222
P796-SNB	143	PA0223-MB	51	PW554-SN	60	VP5000	225
P796-W	144	PA0223-SN	50	PW555-SN	60	VP5001	225
P8005-LP	139	PA0621-VP	153	PW596-SN	60	VP5002	225
P8007-LP	139	PA0711-BMA	167	S077188-BNV	191	VP5003	225
P8011-LP	139	PA0712-BMA	167	S077188-VB	191	VP5004	225
P8018-LP	139	PA0721-BMA	167	S077189-BI	193	VP5124-14	224
P8048-DAC	140	PA0923-WOA	141	S077189-CH	193	VP5125-14	224
P8048-LP	139	PA0924-WOA	141	S077190-BGB	191	VPA0221-SN	222
P8048-ST	139	PA1021-BYA	153	S077190-BI	191	VPA1218-SN	223
P8049-DAC	140	PA1021-RI	153	S077190-CH	191		
P8049-LP	139	PA1021-VP	153	S077190-SN	191		
P8049-ST	139	PA1021-WOA	119	S077192-14	192		
P813-W	59	PA1022-WOA	119	S077192-BGB	192		
P814-W	59	PA1023-WOA	119	S077192-SS	192		
P8157-DAC	140	PA1211-WOA	119	S077192-VB	192		
P8157-ST	138	PA1213-WOA	119	S077194-14	190		
P8165-LP	139	PA1214-WOA	119	S077194-CH	190		
P8169-LP	139	PA1216-WOA	119	S077194-SN	190		
P817-BL	59	PA1217-MB	119	S077194-VB	190		
P818-BL	59	PA1217-SN	119	VO2P27120-AB	226		
P8196-DAC	140	PA1218-BYA	153	VO2P27120-BL	226		
P8196-LP	139	PA1218-MB	119	VO2P27120-CH	226		
P8196-ST	139	PA1218-RI	153	VO2P27120-PB	226		
P8257-LP	139	PA1218-SN	119	VO2P27120-SC	226		
P8258-LP	139	PA1218-VP	153	VO2P27120-W	226		
P8293-AB	213	PA1218-WOA	119	VO4P27120-AB	227		
P8293-LP	213	PA1311-BI	149	VO4P27120-PB	227		
P8293-SM	213	PA1311-RI	149	VO4P27120-SC	227		
P8293-SN	213	PA1312-BI	149	VO8H076998	207		
P8293-VB	213	PA1312-RI	149	V10HH075593-SS	222		
P8294-AB	213	PA1321-BI	149	V10HH075593-VB	222		
P8294-LP	213	PA1321-RI	149	VPI21-SN	223		
P8294-SM	213	PA1322-BI	149	VPI35-SN	222		



**HICKORY**  
HARDWARE®

---

**USA**

3100 Broadway SW  
Grandville, MI  
49418

Phone: 1.800.235.9484  
Fax: 1.800.858.2119

[www.hickoryhardware.com](http://www.hickoryhardware.com)

---

**CHINA**

RM H, I 20/F Baofa Building  
2015 Shenyang Rd, Yan Tian District  
Shen Zhen, China  
518081

---

**DISCLAIMER**

The information in this catalog is based on the latest product information available at the time of printing. The right to discontinue items without advance notice and to make changes as to color, materials and other specifications at any time is reserved.